

INTERNATIONAL CONFERENCE ON PHOSPHORUS RECOVERY FROM SEWAGE AND ANIMAL WASTES

Warwick University, UK. 6th & 7th May 1998

Summary of conclusions and discussions

Compiled by Chris Thornton, CEEP

Contents

Summary of conclusions

- partnership for the future
- potential for P recovery
- the obligation to remove P from waste waters
- phosphorus removal versus phosphorus recovery
- economic and technical feasibility
- paybacks for the water industry
- conditions for P recovery
- phosphorus recycling and the phosphate industry
- conference conclusions
- areas for research

Summary of discussions

(1) Boundary conditions for phosphorus recovery

(2) Phosphorus recovery and the water industry

- future sewage sludge disposal options
- agricultural sludge disposal
- sludge disposal and nutrient management
- P removal by chemical precipitation
- P recovery technologies and P recycling in the phosphate industry
- P recovery and biological P removal

(3) Phosphorus recovery from animal waste

- the role of regulators
- P recovery potential of chicken litter

(4) Calcium phosphate recovery

- operating experience
- further research areas regarding calcium phosphate recovery

(5) Struvite formation as a route for phosphorus recovery

- operating experience
- struvite and the phosphate industry
- struvite and the waste water industry
- agricultural value of struvite
- areas of research regarding struvite recovery

(6) Economic feasibility of phosphorus recovery

- cost estimate exercise
 - suggestions for further economic investigations
 - conclusions of the economics workshop
-

List of papers and posters available on the web or on request

Summary of Conclusions

World wide interest in Recycling Phosphates from Sewage

Partnership for the future

The first international conference on phosphate recycling, organised by the Centre Européen d'Etudes des Polyphosphates (CEEP), brought together more than 100 industry and water company decision-makers from across the world, along with scientists and researchers, regulators from environment and agricultural authorities and the European Commission.

Political will is needed to exploit the potential for phosphate recovery from sewage and animal wastes, the conference at Warwick University concluded. **"This will require a partnership involving the water and animal waste industries, government authorities and the phosphate industry"** affirmed John Driver, chairman of the conference. **"The phosphate industry is taking the lead in this. We are convinced that the future lies in phosphate recycling and consider that within a decade up to 25% of phosphates used in detergents and other high-grade applications could be recovered from sewage and animal wastes"**.

Potential for P recovery

The quantities of phosphorus present in sewage and animal waste are significant compared with the needs of the detergent and high grade phosphate industry. EC regulations and local environmental objectives are making phosphorus removal from waste waters increasingly widespread. These two facts mean that in the future phosphorus recovery for recycling could become economically viable. The conference heard that in the UK around 40 million tonnes of domestic sewage* is produced each year as well as some 150 million tonnes of farm animal wastes. A further 150,000 plus tonnes is excreted directly onto fields.

* tonnage of organic wastes present in sewage before dilution with tap and rain water.

These wastes can be estimated to contain around 45,000 and 200,000 tonnes, respectively, of phosphorus (as P). Together this represents approximately six times the consumption of phosphate products in the UK (detergent phosphates and other high grade applications such as metal cleaning, pharmaceutical and food uses).

Recycling -- a viable option

It is likely that a significant proportion of this P would be available for recovery. Logistical reasons, such as the cost of transport and the scale of installations, will make recovery for recycling likely to be an economic option only in the case of large, geographically concentrated waste streams (sewage from urban areas, intensive animal production). In rural areas, agricultural sludge or manure spreading will remain the best option for recycling nutrients.

Only part of the P in each waste stream can feasibly be recovered. In sewage treatment, for example, recovery is most efficient in side stream processes and in this case a significant proportion (probably 40 – 50%) of the P will be "lost" into sludges. A higher proportion could be recovered by hydrolysing the sludges to release trapped organic phosphates.

However, in the UK, even a conservative estimate of the potential for P-recovery and recycling (50% recovery applicable to 25% of sewage and to 15% of animal wastes) represents half of industrial phosphate demand. Fertiliser and animal feed, however, use 5 - 6 times more phosphates than industry.

The obligation to remove P from waste waters

The European Urban Waste Water Treatment Directive 91/271/EEC (21st May 1991) requires P removal to be installed at all, except very small, sewage works in eutrophication sensitive areas by December 31, 1998. Eutrophication sensitive areas are designated by national governments of member states. These are all lakes, rivers, estuaries and coastal waters which are already eutrophic, or may be vulnerable unless protective measures are taken. Within these sensitive areas (by Article 5.2 of the Directive) P-removal must be installed at all sewage works serving conurbations of more than 10,000 pe (person equivalents). This treatment (Annex I.2.b of the Directive) must remove at least 80% of phosphorus and reduce concentrations in the outflow to below 2 mg/l (1 mg/l if > 100,000 pe). 70-80% of dissolved nitrogen must also be removed. Although this Directive is not yet universally applied, and the 1998 deadline will not be fully respected in some Member States, it is clear that P removal will increase in sewage treatment across Europe in the near future. The national definition of sensitive areas is subject to regular revision. A tighter definition would bring more waste water treatment plants into the remit of the Directive.

P removal versus P recovery

Where P is removed from waste waters, it is transferred to sludge, either in an organic form -- biological P removal, or as a chemical precipitate --chemical P removal.

The majority of sewage works equipped with P removal in Europe use chemical precipitation, often simultaneous with secondary biological treatment with the result that the chemical precipitate is mixed into the organic sludge. Iron compounds are the most widely used chemical for P removal, although aluminium compounds can also be used. This means that sludge volumes are increased not only by the addition of phosphorus as phosphates, iron or aluminium are also added.

Effective P removal requires higher concentrations of precipitation chemicals than will actually combine with the available P, further increasing sludge volumes. John Upton, Severn Trent Water, UK, indicated that P removal using iron precipitation increases sludge volumes by 40% on average. This method also results in increased chloride concentrations in outflows. Iron precipitated phosphorus is not readily available to crops. The excess of iron salts in sewage sludges can fix existing P in soils further reducing its availability to crops. This reduces the value of these sludges for agricultural spreading. Where sludge is incinerated, the phosphorus compounds are non combustible, reducing the calorific value of the sludge and increasing ash volumes needing to be landfilled. Recovery of P for recycling, rather than its transfer into sewage sludges, offers economic and environmental paybacks for the water industry. These benefits must be compared with the investment and running costs of P recovery installations.

Economic and technical feasibility

The conference examined the technical pathways currently under development as well as the economic boundaries which would make P recovery a viable option. These discussions are detailed below and summarised here.

Economic viability will depend to some extent on the price the phosphate industry is prepared to pay for the recovered product, the costs for the water industry of Precovery compared to P removal processes, and predominately on sludge disposal routes and costs.

The phosphate industry might reasonably be expected to pay a small premium for recovered P, compared with mined phosphate rock, as it contains lower levels of heavy metals and other problematic contaminants than most natural rocks.

Transport costs, however, will be significant for phosphates recovered from sewage works spread over the country. A medium-sized sewage works, of 100,000 pe, might produce 1-2 lorry loads of recovered phosphates per month.

The calcium phosphate Crystalactor® plant at Geestmerambacht, Holland, produces 200 – 300 tonnes/year of phosphate pellets from a 230 000 pe sewage works.

Hideo Katsuura, Unitika Ltd, Japan, indicated that phosphates recovered as struvite by his company are currently sold to the fertiliser industry at around \$150/tonne (13.5% P).

The conference looked at the costs of P recovery processes. Several pilot, and full scale plants, have been tested or are already operating in different countries, recovering phosphates from waste water streams through calcium phosphate or struvite formation (see below).

Both pathways can produce pellet-like solids which are readily drained to below 5-10% water and can offer 5 – 15% phosphorus content. For comparison, mined phosphate rock currently used by industry typically has a 20% phosphorus content.

Other techniques for P recovery exist at the lab or experimental scale, including ion exchange and recovery from sludge incineration ash.

- pilot plants at sewage works :

- Darmstadt, Germany (Karlsruhe University pilot financed by CEEP, 1997-1998), fluid bed reactor 270l/h ;

- Chelmsford, UK (Essex and Suffolk Water [Compagnie Générale des Eaux]/DHV, 1997-1998), DHV Crystalactor® 700 l/hs ;

- Warriewood, Australia (Sydney Water/Australian Water Technologies fluidised bed demonstration plant, April 1995 – March 1996. 50,000 pe and 120,000 l/day) ;

- Westerbork, the Netherlands (DHV Crystalactor®, 1988).

- full scale plants :
- Japan, Shimane Prefecture (Unitika Ltd, struvite production from sewage), 45,000 m³/day, commissioning September 1998;
- Japan, UBE Industries Sakai plant (Unitika Ltd, struvite production), 48m³/day, running since 1995 ;
- the Netherlands, Geestmerambacht (Uitwaterende Sluizen Waterboard Edam, 230,000 pe.) and Heemstede (35,000 pe), DHV Crystalactors® forming calcium phosphate from sewage ;
- Avebe, the Netherlands (struvite from food industry wastes, DHV Crystalactor®, 150m³/h) ;
- Putten, the Netherlands (precipitation of potassium struvite from 700,000 tonnes/year of calf manure, Geochem Research and Delft University) ;
- Gaggenau, Germany (precipitation of calcium phosphate from industrial waste waters, Mercedes Automobiles/Karlsruhe Research Centre), 160 m³/h.

Other full scale plants are known to be functioning using a calcium phosphate recovery process developed by Kurita Water Industries Ltd but precise details are not currently available.

The economics of these operations were examined. Costs are very difficult to assess as these plants have been designed as experimental or demonstration processes and design and running costs should significantly reduce with engineering and operating experience.

Paybacks for the water industry

P recovery offers the potential to significantly reduce sludge production compared with established P-removal processes. The economic payback will depend largely on the sludge disposal options available. Several participants underlined the tendency to limit agricultural spreading of sludge, because of local nutrient excesses, risks of heavy metal or pathogen contamination, local public resistance (odour problems) or because of problems of food industry acceptance. Quality charters defined by supermarket chains, oil mills or dairy industries, in many countries, increasingly proscribe sewage spreading.

P recovery can also relieve the water industry of certain operating problems. Struvite precipitation in pumps and pipes will be prevented downstream of P recovery. Heavy metals may have a natural tendency to be trapped in recovered phosphates, reducing contamination of outflows or sludges. The phosphate industry is well equipped to deal with these metals with in existing processes. P recovery is generally readily compatible with nitrate removal, and can even directly contribute to this, if P is recovered as struvite.

Conditions for P recovery

It is probable that P recovery for recycling will be viable only in certain situations:

- sewage works subject to the obligation to remove phosphorus ;
- large or concentrated waste streams, ie sewage works in urban areas or intensive animal production, where transport of the recovered P can be rationalised and where recovery installations would be of an economic scale ;
- areas where the low cost option of agricultural spreading of sewage sludge or manure is not available.

Although the proportion of wastes concerned by these criteria is difficult to assess, the conference concluded that it is probably significant and certainly will increase over coming years.

P recycling and the phosphate industry

Phosphates used by industry and in fertiliser manufacture are currently extracted from mined phosphate rock, a non renewable resource. Most of Europe's needs are imported, in particular from Morocco, South Africa and Russia.

A limited resource

Recovery of phosphates from wastes therefore enables industry to replace an imported non-renewable resource with a sustainable recycled raw material.

The conference heard from Ingrid Steen, Kemira Kemi Sweden and CEEP Chairperson, that world reserves of phosphate rock are currently estimated at around 100 years, depending essentially on the rate of intensification of agriculture in developing countries. This time scale, based on commercially exploitable reserves using current technology, is around twice that currently estimated for the depletion of petroleum reserves.

Current phosphate rock reserves mean there is no short, or medium, term pressure on industry to turn to recovered phosphates. The phosphate industry underlined to the conference, however, that the quality of rock available to industry is already deteriorating with a lower P content and higher contaminant content (heavy metals, iron, aluminium). John Driver, Albright and Wilson, UK, indicated that the P content of rock available to industry has been falling by an average of around 1% per decade.

Sustainable raw material

Recovery of phosphates will, in most processes, concentrate much of the heavy metal content out of waste waters, in particular sewage, into the recovered phosphate product. This may have significant advantages for the sewage works operator. Even so, the recovered phosphate products will contain levels of heavy metals -- one or two orders of magnitude lower than those found in phosphate rock.

The phosphate industry is well equipped to remove heavy metals in its processes, although at a cost. Recovered phosphates offer both a quality premium to the phosphate industry and an opportunity for the water industry to eliminate problematic contaminants.

Cadmium, in particular, has been the focus of much attention in phosphates imported for fertilisers. There is an expectation that standards will tighten significantly in this area. The EC, it was noted, is financing a project to remove cadmium from phosphates mined in Morocco, on site, to avoid their transfer to Europe.

Redefining industry structure

The use of recovered phosphates, produced in appropriate chemical forms, should not present a processing problem for the phosphate industry. They would however necessitate a major redefinition of the industry's structure and logistics.

The European phosphate industry's structure has increasingly moved towards a small number of large production plants. There is only one remaining phosphorus furnace site in Western Europe (Vlissingen, Holland) and less than a dozen phosphoric acid plants (phosphoric acid is also imported from production plants situated alongside the phosphate rock mines).

In the long term, the use of small, diffusely produced quantities of recovered phosphates would necessitate restructuring the phosphate industry. Small local production units and appropriate stocking, grouping and transport systems may be needed.

In the short term, to get recovery started, it may be more appropriate for recovered products to be recycled locally in agriculture.

Positive future

The conference heard that, despite these challenges, the European phosphate industry is convinced, at top strategic management level, that P recovery represents a feasible and positive future.

The organisation of this conference by CEEP, the joint research fund of the European phosphate industry and sector Group of CEFIC (European Chemical Industry Federation), confirms this conviction.

The overall objective of the conference was to look at how to move towards this sustainable vision for the future.

The conference requested that the phosphate industry establish a clear description of its wishes, and requirements, regarding the chemical and physical form of P recovery products - including the impact on the value of such products of different factors.

Conference conclusions

It was concluded that phosphate recovery and recycling must involve the high grade phosphate industry (represented by CEEP, the organisers of the conference), but also the fertiliser and animal feed industries : all of whom use phosphate rock as a raw material.

Recovered phosphates will be most appropriately recycled through one or more industries, depending on the site of production, local markets and the recovered product type.

Local solutions

Recovery for recycling will be logistically, ecologically and economically viable if it is developed for waste streams from municipal and industrial waste waters, as well as from agriculture, and recycled back to the consuming industry offering the best local solution.

The conference clearly indicated that from the waste operator's, or regulator's, point of view, there is no reason to distinguish recycling back into agriculture from that into high grade phosphate products as the phosphate industry is perceived externally as a "whole", including all these sectors.

The phosphate industry representatives present (CEEP) agreed to enter into discussions regarding phosphate recovery with both the animal feed industry and the mineral fertiliser industry.

Joint research and development

The conference concluded that joint research and development is necessary between the water and waste industries, the phosphate industry and environmental regulators. The objectives should be to improve the economic efficiency and to generalise the technical know-how of phosphate recovery for recycling, both into fertilisers and high-grade industrial phosphates for detergents and industrial uses.

Regulator support

The political and financial support of regulators (environment, industry and agricultural authorities), and in particular the EC Commission, will be important to enable this joint research and development to be launched. Industry called for political leadership and EC research support in this area.

Areas for research

The conference identified the following areas where scientific research and development are necessary to give a better understanding of the feasibility and potential for P recovery :

- economics of P recovery : costs, payback for industry, paybacks for the water industry and waste operators, and the way these economics may change over coming years ;
- economic study of existing P recovery plants and estimation of cost improvements possible through wider application and experience ;
- establishment of an economic model of costs and paybacks for P recovery in different situations
- study the chemistry of the two currently developed P recovery pathways (calcium phosphate and struvite formation) : complexities of crystallisation / precipitation of the different complex molecules of these products, their formation conditions and reaction kinetics ;
- lab scale experimentation of calcium phosphate and struvite formation to obtain a better practical understanding of their application in a waste water context : investigation of chemical and physical conditions for phosphate product formation in different processes and waste water media ;
- effects on phosphate product formation of potential inhibitors likely to be present in waste waters : organic molecules, metals;
- potential of phosphate formation for P recovery as a route for removing heavy metals from waste water streams ;
- research into other P recovery routes, in particular ion exchange ;
- technical and economic feasibility of the use of different recovered phosphate products by the phosphate and fertiliser industries, in existing or modified process routes;
- use of struvite and potassium struvite as a fertiliser and by the phosphate industry
- construction of demonstration scale, mobile P recovery installations, for both calcium phosphate and struvite recovery, designed for testing P recovery performance in different conditions (varying operating criteria, different waste water streams ...)

The conference provided the first contact between a significant number of organisations and individuals who confirmed their intention to put together programmes and initiate research. The diffusion of this document should extend these links to the hundred plus other organisations that expressed interest but were unable to attend.

Summary of Discussions

(1) Boundary conditions for P recovery

Phosphate recovery for recycling will only be technically and economically viable in certain situations. For municipal waste water treatment plants, the conference identified the following criteria which will define this:

- P removal installation :

P recovery will only be viable where P removal is installed. Application of the EC Directive 91/271 will significantly increase the number of sewage works concerned in the coming few years ;

- sewage sludge disposal options and costs, including investment and running costs for thickeners and digesters : where agricultural spreading is possible, this is usually the cheapest method of nutrient recycling ;

- size of sewage works :

scale of installations and collection costs for recovered phosphates mean that P-recovery is most likely to be attractive in medium to large sewage works ;

- sewage works typology and current state of modernisation :

P removal is more easily integrated into biological P-removal systems or in sewage works where P removal has not yet been installed ;

- N removal :

P recovery can facilitate N removal, via struvite, and is more easily integrated into plants fitted with N removal ;

- quality of recovered P : handling properties, P content, concentrations of impurities:

the phosphate industry may be prepared to pay a premium for a high P product ; levels of most contaminants will be considerably lower than those found in currently exploited mined phosphate rock ;

- presence and options for management of heavy metals :

P recovery can offer the water industry a removal and disposal route for such contaminants ;

- capital costs : critical size/capacity ratio ;

- running costs for P recovery, chemical costs for P recovery compared with P removal by precipitation ;

- impact on sewage works operating problems :

P recovery may facilitate operation by avoiding phenomena such as accidental struvite precipitation in pipes and on pumps ;

- operator know how and "culture" :

P recovery is a relatively complex process to pilot compared with chemical P precipitation but is comparable with the operator control know-how developed in modern sewage works

using biological P removal or nitrogen removal ;

- P content of waste water stream :

higher P contents render P recovery more economic ;

- logistics of recycling of recovered P : transport costs, structure of the phosphate

industry, possibilities for the development of local processing units : the phosphate industry will have to evolve and modify its structure in order to establish a

stable market for recovered phosphate products ;

- public opinion :

the public needs to understand the contribution of P recovery and recycling to sustainable development. The risk of public concern over the "health aspects" of recycling constituents of sewage needs to be addressed.

Participants estimated that in the UK, for example, P removal is currently installed in 23 sewage works, and will rise to 80 by the end of 1999, and 200 by the year 2000.

These are mainly the country's largest sewage works, so that by this latter date, around 50% of the UK's municipal waste water flow will undergo P removal.

Increasing costs for sludge disposal, in particular the obligation to incinerate sludge, renders P recovery more attractive. This is due to a reduction in sludge volumes resulting from P removal (elimination of phosphates and avoidance of the addition of larger than stoichiometric quantities of iron or other salts for P precipitation).

It was affirmed that there is no health risk from industrial recycling of phosphates from sewage. No pathogen can conceivably survive the pH and temperature conditions of the chemical processes used by the phosphate industry. This does not

eliminate the possibility of adverse public opinion associated with the concept of recovering ingredients from sewage and animal wastes for uses such as detergents, food additives, animal food supplements.

(2) P recovery and the Water Industry

Future sewage sludge disposal options

A number of questions remain concerning the future for sludge disposal options :

- agricultural spreading of sewage sludge is increasingly under pressure, for reasons of nutrient saturation of soils, distance from urban waste water treatment works to sufficient farmland, contamination of soils with heavy metals, pathogens or other

pollutants, local opposition because of nuisance problems and image problems ;

- landfill and sea dumping options are disappearing through environmental legislation ;

- alternatives to spreading include biogas generation, composting and hydrolysis : however, the "markets" for nutrients in the resulting products (and in particular for phosphates) are limited ;

- finally, incineration is a very costly route for sewage sludge disposal. Taken together, these different factors mean that the reduction in sludge quantities

resulting from P recovery can be a very significant economic factor.

Agricultural sludge spreading

There was a general view that the disposal of sewage sludges to farmlands will increasingly be limited and expensive in the future.

On the one hand, the areas of land available for spreading are decreasing (for the reasons given above). On the other hand, the effective application of the EC Urban Waste Water Treatment Directive will increase sludge volumes. Further tightening of urban waste water treatment obligations are likely in the future and will accentuate this.

Sewage

The option of agricultural spreading of sewage will depend on the local context. In France, for example, sewage from urban areas is increasingly incinerated : geographical concentration and suburban development means that there is insufficient farmland locally available for spreading and leads to opposition from inhabitants. However, in rural areas sewage is generally spread on the land. France is a large country and small towns away from the large cities have large areas of farmland accessible. However, even in rural areas, agricultural spreading is being questioned and limited for reasons of contamination from various pollutants.

Animal wastes

For animal wastes regulations regarding spreading on land are also becoming much tighter, and therefore increasingly costly. Also, the tendency towards intensification of animal husbandry leads to localised surpluses of farm wastes in excess of the capacity of nearby farmland to accept manure.

Knowledge gap

Farmers and waste producers will have to solve nutrient management problems if they are to stay in business. P recovery may provide a solution in some circumstances but there currently seems to be a significant knowledge gap between industry and waste providers relating to scale, economics and logistics, etc.. New legislation needs monitoring and influencing so that it is directed towards real environmental goals. Soils should not be used as sinks for unwanted materials.

Quotas

Quotas for sludge spreading are often limited by the nitrogen content, not the P content. This can lead to excess levels of phosphates in soils where sludges have high P contents (P removal fitted in sewage works). P recovery could improve this situation. Bob Foy, of the Northern Ireland Department of Agriculture, indicated various problems with the agricultural use of sewage sludge. Increasingly, supermarket chains require that land used to supply quality assurance produce should not be treated with sludge. He suggests that sludge from sewage works equipped with chemical P precipitation does not provide available phosphorus for crops. On the contrary, sludge rich in iron or aluminium may deliberately be used as a means of fixing phosphorus and reducing leaching and runoff.

Sludge disposal and nutrient management

Although P recovery from sludges was seen as making a valuable contribution to environmental management, the need to solve all sludge disposal problems was also raised. Bengt Hultman, of the Swedish Royal Institute of Technology, underlined the need to recycle all the materials in waste waters -- nutrients, energy/carbon content, metals ... Recovering phosphorus would reduce the value of sewage sludge for farmers if carried out in isolation.

Residual sludge

With the development of P recovery, the problem of residual sludge disposal still remains. This has, to some extent, been addressed in Scandinavia : in experimental processes, sludge is treated with acid, or steam, to hydrolyse it, thus releasing more of the nutrient value. The economic and technical feasibility of such processes remains to be proved, however, as they involve significant energy and chemical input, as well as high investment costs. Bengt Hultman suggested that hydrolysis of sludge would enable 90%, rather than 40-50%, of P to be recovered for recycling. Composting is not a viable solution for sludge treatment and nutrient recycling as it is too energy intensive and has a very limited market due to competition from other compost products.

P removal by chemical precipitation

Many European sewage works performing P removal to comply with environmental outflow regulations currently use chemical precipitation using iron (Fe) or aluminium (Al) salts. This produces phosphate products which cannot be recycled by industry (see below) and have little or no value as fertilisers as the phosphorus is poorly, or non-available, to crops.

Precipitation for P recovery

The need for P recovery technology was widely recognised as an alternative to precipitation with Fe and Al salts.

Nic Booker, CSIRO Australia, suggested that more than double stoichiometric concentrations of iron salts must be added to waste waters to achieve P precipitation down to outflow concentrations of 0,5 mg P/l. Significant quantities of available iron would be present in this sludge. Where this is spread on fields, not only is the phosphorus in the sludge poorly available to crops, but the available iron would further reduce availability of existing soil phosphorus.

P recovery technologies and P recycling in the phosphate industry

Chemical P removal by traditional methods will generally preclude P recovery for recycling by the phosphate industry because the phosphorus is precipitated out using iron or aluminium salts. The resulting iron or aluminium phosphate compounds are incompatible with technologies currently used in the phosphate industry. They either requiring excessive energy input, to separate the phosphates from the added precipitation chemicals, or interfere with the industrial process. John Driver, Albright and Wilson, UK, indicated that approximately 2% iron is the maximum which can be dealt with in the "wet acid" phosphate industry processing route.

Dees Lijmbach, Thermphos, Holland, indicated that 1-2% iron, and approximately 2% aluminium, are the maximum levels admissible with existing technology in the thermal process route.

Workable technologies

Various technologies enable P recovery in a chemical form that can be recycled by the phosphate and/or fertiliser industries.

The routes for the formation of calcium phosphate, or struvite, are already well developed, and both demonstration and full scale plants are running. These routes were discussed in workshops at the conference, summarised below. Experimental installations have also been studied using ion exchange, magnetic precipitation and other techniques. These merit further investigation, but their application in a waste water context may prove problematic.

Nic Booker particularly underlined the interest of the "RimNut" ion exchange system because of its applicability to large volume streams of waste water with high organic concentrations. In contrast most existing P recovery technologies are best adapted to a relatively "clean" side stream.

Sludge incinerator ash can contain a high level of phosphates, similar to incinerated chicken litter. The latter may be more appropriate for P recovery. Sewage sludge incinerator ash is very variable rendering difficulties in the design of industrial recovery processes. Also, if the sludge is produced via chemical precipitation of P by iron or aluminium, these chemicals will prevent P recovery.

P recovery and biological P removal

Biological P removal may offer interesting opportunities for P recovery. Marc van Loosdrecht, Delft Technical University, Holland, explained that bio P removal know-how has significantly improved over recent years. Plants have become reliable and offer very efficient P removal. Well managed modern plants generally enable outflow

concentration to remain within regulatory limits without further chemical P precipitation.

Bio P removal plants include a side stream, or return stream, with a relatively high P concentration in lower volumes than the main stream -- and usually with relatively stable conditions. This is particularly appropriate for P recovery. However, only around 50% of the input P will be available for recovery in such a side stream, the remainder being fixed in the organic sludges.

One of the difficulties is that the P is fixed into aerobic sludge. This is susceptible to releasing the P if it becomes anaerobic at any stage before effective disposal (such as through spreading or incineration), and in particular, during thickening processes. P

recovery can alleviate this problem by transferring much of the P into recovered products, rather than into sludge.

Removal performance

Nic Booker, CSIRO Australia, underlined the problems of process control for bio P removal. Outflow concentrations of < 0.5 mgP/l are obtained when bio P plants are run by engineers, but often not

by waste water operators. The main factor influencing bio P removal performance is usually the control of organic substrate quality and concentration.

It is noted that the kind of engineering know how and control necessary to effectively run bio P removal plants is comparable to that necessary for P recovery technologies, which are also relatively sensitive.

(3) Phosphorus Recovery from Animal Waste

Dees Lijmbach, Thermphos, Holland, reviewed the presentations at this workshop by Dr. Haygarth (UK Institute of Grassland and Environmental Research) and Leo van Ruiten (van Ruiten Adviesbureau, Holland).

Manures contain differing amounts of P. Manure production in Holland is quite different from the UK in that it is concentrated in three provinces. There are regulations limiting the level of P application to farmland. For these reasons, the manure needs to be moved within Holland, exported or processed.

Participants requested better information regarding the quantities and forms of manure. Some forms may be advantageous for land application while others are better processed.

Optimising manure as fertiliser

There was some discussion of reducing the phosphorus content in non ruminants' manure by added phytase. It was pointed out by a feed supplier that this has to be done carefully to avoid associated health risks.

It is preferable to optimise the use of manure as fertiliser before looking at other options. It seems illogical to take the nutrient resource off the farmland and import chemical fertilisers. This will require improved farming practice : farmers will have to track the P cycle on their farm, noting incoming feed and fertiliser and outgoing manure and crop products. Farmers need to know how much of the P in the manure is available to crops.

When applying manure to land nitrogen content and odour should also be considered.

There are concerns of storage problems and potential leaching and transfer to water after spreading. Strategies need to be established to minimise nutrient transfer to watercourses.

Land spreading may be the best solution in the UK since livestock is not as concentrated as in Holland but alternatives still need to be developed. Transfer of manure to neighbouring regions should be considered but poses transport problems and costs.

Incineration is viewed as the next best option to land spreading.

There were concerns that legislation might change these suggested use options. There are economics to consider and these will vary by region and animal type.

Stabilisation of the manure -- to make it available when the farmer needs it and improve handling and transported -- is an important area for research. Production of biogas from manure prior to spreading can reduce odour, eliminate weed seeds and ensure stabilisation and drying -- therefore reducing transport costs. It was pointed out that incineration also addresses these issues.

Phosphorus may be too inexpensive a commodity to make recovery and sale attractive today. But as a valuable and limited resource, the price can be expected to increase over the long term as reserves are depleted -- although there are no trend in this direction can yet be identified.

The role of regulators

Legislation may be the only way forward. Common Agricultural Policy rules will change the way we farm. Except in certain cases, such as very large industrial production units and chicken litter, P recovery from manure is only likely to be adopted if and when better nutrient management requirements are imposed by regulators.

The phosphate industry believes, however, that it is important to initiate research and development into recovery from animal wastes because they represent a concentrated and relatively homogenous source of phosphorus and because a tightening of regulations is highly likely, even if the time scale is not currently known.

Farmer involvement

The average farmer does not want to be involved with the P cycle and would sooner let the experts handle his manure problem. However, farmers are unwilling to pay the costs of processing manures. This has led centralised

processing factories to fail for economic reasons.

There is no clear competent body to take a role as a player for P recovery alongside the phosphate industry. Waste operators are rarely structured -- no equivalent of the water industry exists -- and farmers' organisations are not generally motivated on this subject.

The phosphate industry will have to address regulators to make progress on P recovery from animal wastes.

Viability

Leo van Ruiten's report, produced for CEEP (a draft of which was presented at the conference), concludes that for Holland, despite the large quantities of calf and pig manures, it is improbable that P recovery from these sources will be economically viable in the near or medium term future.

Recovery of P from incinerated chicken litter is the most likely route for P recovery. Chicken litter is produced in large, concentrated farms, is readily incinerated (high dry matter and energy content), producing ash high in phosphate but difficult to use for agricultural spreading.

Potential of chicken litter for P recovery

Fibrowatt in the UK is currently incinerating chicken litter to produce energy and a fertiliser product.

The company pays farmers for their litter if it meets set moisture specifications -- ie does not have too high a water content.

The resulting fertiliser, produced by combining the recovered fly ash and solids, is sold to farmers at the same price as mineral fertilisers. Transported up to 60 – 70 km, this incineration product is currently only listed as fertiliser in the UK, not in the E.U.

A slow release product, the fertiliser has gained significant repeat business. As additional plants come on stream, tow more are under construction, there may be a need to find other uses.

A chicken litter incinerator costs around £70 million to build, including gas cleansing and scrubbing equipment. Regulations require them to use at least 85% chicken litter as fuel.

The volumes are currently too small for industrial phosphate producers. Fibrowatt asked whether the phosphate industry would be prepared to pay higher prices for this material, than for phosphate rock, as it contains lower levels of heavy metals.

(4) Calcium phosphate recovery

Operating experience

The calcium phosphate P recovery pathway has been developed to full-scale plant level. Operating, and laboratory, experience are available from a number of plants :

- fluid bed "crystallisation" installations :
 - DHV "Crystalactors"® at the waste water plants of Westerbork (demonstration plant, 1998, 12,000 pe), Heemstede (35,000 pe) and Geesmerambacht (230,000 pe, running since 1994) in Holland ;
 - pilot plant developed by DHV and Essex and Suffolk Water (Compagnie Générale des Eaux) at Chelmsford sewage works, UK, 1997-1998 ;
 - experimental pilot reactor tested developed and tested for CEEP by Karlsruhe University at Darmstadt Süd sewage works, Germany, 1997 – 1998 ;
 - demonstration plant developed at Warriewood, Australia, by Sydney Water (50,000 pe., 1995-1996) ;
 - three plants constructed by Kurita, Japan.
- fixed bed precipitation installations :
 - Mercedes motor car factory at Gagenu (160m³/h, running since 1996).

These plants produce calcium phosphate "pellets" with a P content of 5 to 15%. The calcium phosphates would appear to be deposited by amorphous precipitation around the seed material, rather than true crystallisation. This is a complex chemical

process and neither the chemical nor the physical parameters are fully understood. The chemistry is made more complex because calcium phosphate is not one molecule but potentially a number of different compounds - calcium hydroxyapatite, dicalcium phosphate dihydrate, octacalcium phosphate, tricalcium phosphate ... with different hydration complexes. The solubility and crystallisation properties of these different molecules vary and the balance between them will modify the overall behaviour of a recovery reactor.

Speciation of phosphates

Dr Alan House, UK Institute of Freshwater Ecology, presented a paper outlining the different factors controlling speciation of phosphates and their solubility. The chemical processes occurring in calcium phosphate reactors are separated in space and time. The dynamics of precipitation proceed through nucleation, growth and termination steps throughout the system. Understanding the dynamics of this could lead to improved ways of handling the reaction system. Current processes involve a pH of 9, or higher, in order to drive the precipitation. This implies high chemical costs for lime or other bases. Carbon dioxide stripping may also be necessary, and is installed in most of the pilot and full scale plants, in order to avoid calcium carbonate precipitation at these high pHs.

Improving understanding

Calcium and phosphate ions are often above saturation levels in the sewage effluent at operating pH, or at least in the streams entering P recovery reactors : so why does precipitation not occur without the driving force of high pH ? Answers to this question could offer possibilities for reducing the amount of calcium, or base, added to induce precipitation.

One factor may be the presence of precipitation inhibitors such as organic molecules, fatty acids, polyelectrolytes, magnesium ions, trace metals. Eva Valsami Jones, Natural History Museum, UK, underlined the variety of organic molecules present in waste waters, from small organic acids to large humic and fulvic molecules. Some may enhance mineral solubility, increasing the super-saturation necessary for precipitation ; others may passivate mineral surfaces, assisting the preservation of formed phosphates. Identification of these different organic molecules could be achieved by concentration onto an absorbent, followed by stripping with an organic solvent. If organic molecules were identified as inhibitors, then an organic removal step could be envisaged, either by non-selective -- such as carbon treatment or peroxide treatment, or selective -- for those types of organic species that could be shown to inhibit precipitation.

Seeding materials

There was also considerable discussion of the effects of different seeding materials for calcium phosphate precipitation.

The DHV Crystallactor® plant at Geesmerambacht, Netherlands, uses sand as a seed material. This reduces the P content of the produced pellets, but is acceptable in their current use in chicken feed. The produced pellets contain around 11% phosphorus. Sand is also used at the Essex and Suffolk Water pilot at Chelmsford, UK. Other experiments have used phosphate molecules (hydroxyapatite, DCP) as seed material to obtain a higher P content in the produced pellets, important where transportation of the recovered material cannot be avoided. The Warriewood demonstration plant, Australia, used magnesium oxide powder to raise pH and facilitate phosphate formation, but this proved expensive.

Dr Dietfried Donnert, Karlsruhe Research Centre, Germany, suggested that calcite (CaCO_3) may have advantages as a seed crystal through allowing calcium phosphate formation to take place at lower pHs -- reducing the amounts of chemicals, lime or magnesium oxide used for raising pH -- and reducing carbonate precipitation. This avoids the need to strip CO_2 from input water. It is not clear how these effects are achieved, particularly once the calcite seed material has been coated with deposited calcium phosphates.

Full-scale phosphate precipitation units have been developed for industrial waste waters, using calcite seed material in stirred reactors, at a starch factory and at the Mercedes car factory at Gaggenau, Germany. The resulting amorphous precipitants contained 6 to 10 % phosphorus.

Application of ultrasound was also suggested as a means of improving calcium phosphate formation and lowering operating pH.

Further research areas regarding calcium phosphate recovery

The workshop suggested that research is needed into :

- chemical reactor conditions, in particular how to minimise the high pH apparently necessary to drive precipitation and how to manage varying phosphate concentrations;
- physical reactor conditions, in particular kinetics (flow rates, turbulence), which affect precipitation and agglomeration and inter-particle friction (formation of pellets rather than fines);
- these conditions need to be researched in different waste water operating environments. Determine and report on what parts of the periodic table are present in the water under precipitation conditions at various points in the reactor. What solids are also present? Determine and report on the organic impurities in the water and their concentration;
- role of different "seed" materials (sand, calcite ...). Increased purity levels of the calcium phosphate product may be achieved: for example the product as it is now could be better utilised by industry if the silicate and carbonate levels were lowered;
- interference of other ions and of sewage-derived organic molecules likely to be present in sewage;
- possibilities for improving calcium phosphate formation using ultrasound;
- solubility phases of different calcium phosphate compounds.

This research could best be achieved using laboratory equipment -- to obtain better knowledge of the physical chemistry of the products and reactions involved -- followed by the use of existing full-scale reactors, or pilot plants, to field test the different hypotheses in waste water operating conditions.

The overall objective is to optimise the economics of the P recovery process in a sewage works context. This could be achieved by reducing the quantities of chemicals -- used for CO₂ stripping and to raise the pH -- and by improving the efficiency of P recovery. Reduced capital costs for new calcium phosphate removal plants could result from a simplification of the process.

Comparison of the results between the different existing and pilot plants should highlight areas for improvement. It would also be useful to research the effectiveness of calcium phosphate recovery in removing heavy metals from the sewage stream as this would provide a value added service to the water industry. The phosphate industry is equipped to deal with such contaminants.

(5) Struvite formation as a route for P recovery

This workshop discussed the potential of struvite (magnesium ammonium phosphate) and potassium struvite (potassium ammonium phosphate) formation as a route for phosphate recovery for recycling.

The workshop discussions were summarised by Professor Schuiling, Utrecht Institute for Earth Sciences, who identified two main points :

Struvite as a removal mechanism for phosphate and (some) ammonia :

It is preferable to remove phosphate from wastes in a beneficial way (e.g. bio-available) regardless of the need for recovery. Thus struvite production is preferable to Fe or Al phosphate precipitation.

The need to find or develop market applications for the recovered struvite :

There seems little possibility that struvite would be a useful raw material for the phosphate (non-fertiliser) industry, because it is incompatible with current industrial processes, but nevertheless struvite recovery and recycling offers significant environmental advantages. It is a recovery route which is definitely chemically and technically feasible and has already been demonstrated in full scale plants (Holland, Japan).

Operating experience

Full-scale struvite recovery processes are already operational or being built in Japan and the Netherlands :

- the DHV Crystallactor® fluid bed process is used in a full scale struvite recovery installation at the AVEBE potato processing plant, the Netherlands (150m³/h) ;
- the Unitika Ltd (Osaka) struvite precipitation process is already in application at the Ube Industries Sakai plant (industrial waste waters) and is due to be commissioned in September 1998 at the Shimane Prefecture sewage works, Japan (45,000 m³/day) ;
- the Geochem Research/Delft University Earth Sciences stirred precipitation process produces potassium struvite from 700,000

tonnes/year of calf manure at Putten, the Netherlands (early 1998).

The Unitika Ltd. (Osaka, Japan) process, presented by Mr Hideo Katsuura, produces easily handled granules with a phosphorus content of around 13.5%. The Putten calf manure plant produces crystals with a phosphorus content of around 12.5%. Neither product needs drying other than by gravity filtration.

Struvite and the phosphate industry

Doubts were expressed about the suitability of struvite as a pathway for recovery of P for recycling to the (non fertiliser) phosphate industry. There was doubt that the quantities produced in a sewage treatment plant, even a large operation like Slough, would justify putting in a process to recover P for industry. Local availability of Mg in waste water would also be a factor significantly affecting feasibility.

There was also a view that it did not make sense to recover struvite as a source of P

for phosphate industry, thus discarding the Mg and NH₄ content, when the whole molecule could be used to advantage as a fertiliser.

Struvite was considered to be a much less desirable material for recycling to the non fertiliser phosphate industry than, for example, calcium phosphate. Dirk Van der Ploeg, Thermphos, Holland, indicated that the use of struvite for P recycling by the phosphate industry may necessitate significant changes in processes. For the thermal process route, magnesium would significantly modify slag properties and furnace technology would have to be adapted. Ammonia released during a traditional (oxidative) sintering process would result in increased production of NO_x or N₂O, necessitating scrubbing and posing air pollution or greenhouse gas problems.

For the wet acid process route (sulphuric acid attack), magnesium would exclude the use of struvite as it does not crystallise out in the way that calcium gypsum does. Potassium struvite would pose similar problems due to behaviour of potassium compounds.

Struvite and the waste water industry

Struvite deposit formation is a natural phenomenon that is a widespread problem in waste water treatment operations.

Nic Booker, CSIRO, Australia, termed it "an accident waiting to happen". Deposits form in pipes where waste waters stand between intermittent flows, but also in areas of turbulent flow or pressure change. They thus impede pipes, valves and pumps. There was support for the view that the emphasis should be put on the further development of struvite technology as a means of solving problems at waste water processing plants rather than expecting payback through phosphates in recovered struvite.

Slough sewage works

Steve Williams, Thames Water, UK, presented the case of Slough sewage works where struvite deposits have been causing considerable operating problems by blocking pumps and pipes.

One pipe several hundred yards long requires periodic overnight soaking with sulphuric acid to clear struvite and prevent blocking. Magnetic devices, similar to those used to reduce carbonate precipitation in hard water, have given variable results.

Recovery of struvite from the waste water upstream of deposition problem areas would avoid these problems and thus give significant operating savings.

Contribution to N removal

Struvite recovery also contributes to nitrogen removal from the waste water stream, reducing or avoiding investments necessary to respect soluble nitrogen outflow regulations. In some regions, animal waste provides a higher source of concentrated P-containing waste streams than sewage.

In the UK, chicken waste is a significant potential resource. In the Netherlands the largest resources are in pig waste which is generally thought unsuitable for struvite recovery. Highly viscous, the P is tightly bound and the struvite generated does not separate well. A full scale struvite recovery plant is now functioning in Holland using calf manure.

Agricultural value of struvite

It was recognised that struvite is an excellent material for removing P from waste water or sludge, but that its uses are less well known.

Struvite was generally regarded favourably as a fertiliser, although there was considerable lack of knowledge about how it performs and its value.

Although struvite is relatively insoluble in water, making it valuable as a slow release fertiliser with limited risks of leaching, it is citrate soluble and hence a good nutrient source for plants. Struvite as a farm fertiliser, has the advantage over sewage sludge that it contains no heavy metals and avoids possible overdosing of nutrients.

Little was known about the market for struvite. Farmers in the USA are interested in using it but they don't want to pay. Struvite recovered from sewage is sold for ¥20 per bag in Japan, which is sufficient to recover the costs of production. Compared with this, the stated price in Australia of A\$1700 per tonne seems unrealistic. Recovered struvite could find niche markets. There could be opportunities to make it available to farmers at the local level through direct local processing and distribution by co-operatives or farm suppliers.

Areas of struvite recovery research

The workshop identified the following research areas :

- the need to demonstrate the agricultural value of struvite and study its dissolution behaviour (nutrient release) in soils and accessibility for crops. Existing work in this area needs collating and assessing ;
- the conditions for nucleation and growth under "real" conditions are still incompletely understood. ;
- the ideal conditions for struvite recovery were stated to be high P and NH₄ concentrations and low suspended solids. Kinetics was thought to be the most limiting factor. Research work so far has been mainly carried out using fairly "clean" solutions containing low levels of organic contaminants. Further work is needed on struvite formation in waste waters and in biological nutrient removal side streams and sludges. There is a lack of information on nucleation characteristics and how struvite forms ;
- process control and management will also be important to optimise struvite formation and maximise phosphate removal ; interest in further research into the formation conditions for different forms of struvite : magnesium ammonium phosphate, potassium ammonium phosphate, and possible other substitutions (Mn²⁺ for Mg²⁺ etc) ; experimentation and development of pilot struvite recovery installations in order to test different operating conditions ;
- precipitation may not be the best way to proceed :struvite is more easily crystallised on a fluid bed than calcium phosphate.

(6) Economic feasibility of P recovery

The workshop tried to identify the different factors that will influence the economic feasibility of P recovery from municipal waste water.

Cost estimate exercise

A "typical" case of a medium sized sewage works (500,000 pe) with an average input of 3gP/pe/day and subject to obligatory P removal was examined in order to compare the overall economics of P recovery with removal by chemical precipitation.

Sludge disposal :

- the sludge generated by iron precipitation would be 7.25 tonnes/day of iron phosphate (2.7 tonnes/day of iron as FeCl), on the basis of a 1:1 molar relationship, increasing sludge mass by 22%. However, water industry participants suggested that iron has to be used in up to double stoichiometric concentrations for effective P removal. John Upton, Severn Trent Water, UK, estimated that P removal using iron precipitation increases sludge volumes in practice by 40% ;
- sludge disposal costs were estimated at \$85/t for agricultural spreading, \$360 for landfill and \$600 for incineration ;
- Glen Daigger, CH2M Hill, USA, estimated that the extra sludge generated would require capital investment in expanded sludge handling facilities of up to \$200/t ;
- overall, increased sludge disposal costs were estimated at \$1500 to \$3000 / day.

Chemical costs :

- the cost of FeCl used for P precipitation was estimated at \$1600/day on the basis of stoichiometric 1:1 quantities of iron. This cost may well be doubled in practice as higher concentrations of iron are used.

P –recovery using lime-induced fluid-bed crystallisation :

- such a process would involve chemical costs for lime used (estimated at \$640/day) and for energy consumption in the fluid bed reactor (estimated at \$130/day) ;
- capital investment is estimated at around \$30 million ;
- staff time for operating the fluid bed reactor is not taken into account as difficult to estimate but may not be significantly higher than for P removal by precipitation.

When additional sludge handling investment is added in, the overall payback period is <10 years which, in the US, is generally an acceptable criteria.

The main point to remember here is that this type of cash saving is only applicable when P stripping is already obligatory to meet legislative requirements. The incremental saving of about \$2200/day compared to P stripping by precipitation (chemical and sludge cost savings), is what generates the 10 year payback.

Calculation of recovered phosphate value

The quantities of phosphate pellets generated (about 6T/day or 2000T/yr as pellets) would not be enough to independently support even the simplest industrial phosphate recycling operation.

Feasibility therefore depends on grouping recovered phosphates from a number of sources (several waste water treatment plants, industrial processes, animal wastes) in order to bring together significant quantities without excessive transport and logistics costs.

The current price of phosphate rock at a UK port is approximately US\$ 40 – 50 / tonne (P content around 20%). This would be a reasonable minimum selling price for

the P recovered from sewage as industry processable pellets. However, a higher purity of recovered calcium phosphate product might allow a reduction in processing costs at both the rock digestion and solvent purification stages.

The organic loading of the recovered product may, however, require low temperature calcination for removal – the associated capital, energy and operating costs need to be added into the overall project economics. One option would be to look at on-site acidulation of this product at the SWT to make triple super-phosphate (TSP) : this could involve participation of the fertiliser industry.

Suggestions for further economic investigation

Currently available figures are too approximate to give more than a rough indication of viable economics. The following areas need further research into costs and economics :

- economics of recovery in relation to the size and topology of sewage works: mainstream/ sidestream P recovery, P precipitation versus bio-P ... ;
- capital costs and running costs for P recovery installations. Utilisation of Geestmerambacht and other full scale plant experience : DHV can provide useful insights into design/capital costing. The costs at existing plants, however, are very high because of the experimental or demonstration design of these. The possibilities of cost savings through operating experience and multiplication of plants needs to be examined ;
- potential for developing the triple super-phosphate (TSP) option with the fertiliser industry and of other solutions for local processing or use of recovered phosphates ;
- P content and other qualities of final product, which will affect its market value ;
- need to consider the implications of low P (but high N) sludge on disposal costs.

N removal

Where sewage works currently include denitrification, or where such capacity is to be installed, bio-P removal or recovery adaptation costs are minimised.

Steve Williams, Thames Water, UK, underlined the energy cost of sludge aeration for N removal. The combination of P recovery and N removal may enable some economies at this level. Recovery of P as struvite implies removal of ammonium and can thus enable economies in N removal investments and running costs.

Heavy metal removal

John Upton, Severn Trent Water, UK, suggested that the removal of heavy metals from the waste water stream by fixing them in the P recovery product, would offer a significant cost payback to sewage operators.

There is increasing pressure to remove heavy metals from outflows (eg. revised dangerous substances legislation in the UK). Heavy metals in outflows are likely to be in a soluble form, and may possibly be fixed into calcium phosphate in a P recovery reactor. Heavy metal removal is increasingly a significant cost for waste water operators.

Conclusions of economics workshop

Given a choice, the water industry will generally adopt the cheapest available option which can consistently meet regulatory requirements. Phosphate recovery will only therefore be economically viable where there is a mandatory requirement for P removal. The water industry will only adopt P recovery if it offers a payback of at most ten years compared to P stripping by precipitation or biological methods.

Within the principle of 'sustainable development' should legislation be considered to promote P recovery in order to get the phosphate and water industries to work together?

If recovery from sewage and wastes become a major P source, this would necessitate a restructuring of the P industry. There is also a need to involve the fertiliser industry as a potential major outlet for recovered P products from sewage and animal wastes.

Team partnership

The next step will be to put together a team involving DHV and other processengineers (design and operation of P recovery installations), the water industry (Anglian Water, Severn Trent and other interested companies from the UK and Europe), CH2M Hill (economics expertise and computer model), the phosphate industry and if possible the fertiliser and animal feed industries. This team will rework and refine the figures produced at the workshop and develop a proposal for further research into costs and economics.

**A LIST OF PAPERS FROM:
Environmental Technology, volume 22, number 11, 2001**

The papers listed below appeared in the journal Environmental Technology, in volume 22 (issue 11, 2001). These papers are reproduced with the authorisation of "Environmental Technology" and are subject to copyright of this Journal. No reproduction or use of these papers indicated Environmental Technology is therefore possible without prior authorisation from the Journal at: www.environtechol.co.uk

Robert Burns, Moody L.B., Forbes R. Walker, Raman D.R.

[Laboratory and In-Situ Reductions of Soluble Phosphorus In Liquid Swine Waste Slurries](#)

Ipek Çelen and Mustafa Türker

[Recovery of Ammonia as Struvite from Anaerobic Digester Effluents](#)

Fiona Hogan, M. Mchugh and Suzy Morton

[Phosphorus Availability For Beneficial Use In Biosolids Products](#)

Norbert Jardin and H.J. Pöpel

[Refixation Of Phosphates Released During Bio-P Sludge Handling As Struvite or Aluminium Phosphate](#)

Nicolas Jeanmaire and Tim Evans

[Technico-economic feasibility of P-recovery from municipal wastewaters](#)

Lorenzo Liberti, Domenico Petruzzelli, Loredana De Florio

[REM NUT Ion Exchange plus Struvite Precipitation Process](#)

Katsumi Moriyama, Toshihiro Kojima, Yoshikazu Minawa, Satoru Matsumoto, and Kazuo Nakamachi

[Development of Artificial Seed Crystal for Crystallization of Calcium Phosphate](#)

Simon Parsons, F. Wall, James Doyle, K. Oldring and John Churchley

[Assessing the Potential for Struvite Recovery at Sewage Treatment Works](#)

Etienne Paul, Marie-Line Laval, Mathieu Spérandio

[Excess Sludge Production and Costs due to Phosphorus Removal](#)

Willem Schipper, Bram Klapwijk, Berend Potjer, Wim Rulkens, Hardy Temmink, Ferdinand Kiestra and Dees Lijmbach

[Phosphate Recycling in the Phosphorus Industry](#)

Jan Suschka, Alicja Machnicka and Sebastian Poplawski

[Phosphates Recovery From Iron Phosphates Sludge](#)

Yasunori Ueno, M. Fujii

[Three Years Experience of Operating and Selling Recovered Struvite from Full-Scale Plant](#)

Jacqueline van der Houwen and Eugenia Valsami-Jones

[The Application of Calcium Phosphate Precipitation Chemistry to Phosphorus Recovery: The Influence of Organic Ligands](#)

Kelvin Webb and G. E. Ho

[Characterisation of Waste Solutions to Determine Optimised P recovery](#)

Mark Wentzel, E V Musvoto and George Ekama

Application Of Integrated Chemical - Physical Processes Modelling to Aeration Treatment of Anaerobic Digester Liquors

Phosphate removal & recovery from wastewaters

The article originally appeared in the Journal:
Phosphorus & Potassium, Issue No: 213
(January-February, 1998)

Reproduced with the permission of British Sulphur Publishing

The impact of the phosphate industry on the environment is not solely felt when phosphates are processed, but also when they are used. New methods for recovery of phosphates from wastewaters would lead to an improved level of sustainability in the phosphate cycle. But what are the practicalities?

While the phosphate industry has a major impact on the environment at the point of production because of the wastes generated in the production and processing of phosphate rock for phosphoric acid manufacture (for details see *Phosphorus & Potassium* 209 and 211) that is not the end of the story. Those phosphates are used to grow the crops that feed both animals and man, and also to make non-food products such as animal feed phosphates, technical phosphates and detergents. As a result of their consumption they finish up back in the environment through agricultural waste, groundwater run-off, urban wastewaters and sewage. Viewed in this way, the result of current human endeavour is to take mineral phosphate from discrete deposits around the world (located chiefly, but not exclusively, in the USA, North Africa, the Middle East and the former Soviet Union), and to disseminate it to all corners of the globe where, after primary use, it has the potential to cause eutrophication of inland bodies of water and algal blooms in the seas.

Steps have been taken in many countries to eliminate the worst excesses in agricultural practices that release phosphates back into the environment, and for many years environmentalists have campaigned hard over specific uses, such as detergent phosphates, that were thought to be the cause of the most visible damage. But the major elements of this phosphate pathway still remain substantially in place. Removal and recycle of phosphorus values from all main waterborne sources would lead to far greater sustainability for the world's phosphate cycle, especially as producers are having to adapt their technology to deal with the falling grades of the mineral deposits that remain. This is the view propounded in a recent report undertaken for the Centre Européen d'Études des Polyphosphates E V (CEEP).¹

Origins of phosphate in waterborne sources

Apart from the phosphates that are leached from natural mineral deposits, phosphates enter groundwater and wastewaters from two basic sources:

- 1 Agriculture
- 2 Liquid urban waste, sewage disposal

Those relating to agriculture (from leaching of fertiliser nutrients applied to crops, as well as manures produced by livestock rearing), are largely localised within areas of intensive agricultural activity. These have created environmental problems when water catchments drain into standing bodies of water, such as eutrophication in lakes. In such environments, phosphate is usually the nutrient in most limited supply, and, therefore, its increased availability leads to marked increases in the growth of algae and phytoplankton.

Generally, total phosphorus concentrations in excess of 100 µg P/litre provide sufficient nutrient enrichment in lakes for there to be a probability of eutrophication, and there are many freshwater streams in rural areas in Europe that contain concentrations in excess of 200 µg/litre.² In other words, phosphate losses from agriculture, while they may be small in agricultural terms, can have a significant effect on the environment.

Despite the fact that urban sewage is still considered to be the dominant source of phosphorus impacting freshwater resources on an overall basis, in locations where lakes are draining intensive agricultural areas, agricultural practices can be the predominant source of phosphorus. It is for this reason that the fertiliser and farming community have begun to address the issue of phosphate management at the farm. Modern farm systems, especially those using intensive methods, have seen the need to maintain nutrient balances that include P, and to develop systems to control phosphorus surpluses at the farm level. The term "precision agriculture" has become the new buzzword to describe such technically advanced farm management. But nutrient management

planning must take account of animal manures as well as nutrients supplied as fertiliser, whether animals are reared in confinement or at grazing, if the goal of sustainable agriculture is to be fully achieved.

Generally, however, phosphates arising as potential pollutants from agricultural sources are relatively small and isolated compared to the phosphate loadings contained in liquid urban wastes. By contrast with agricultural wastes and soil run-off, sewage and urban wastewaters arise in large conurbations and in far greater quantity; and the potential for adverse environmental impact from the phosphates they contain are by far the most serious. Estimates vary, but urban residents discharge 2-3g P per capita per day into the sewerage system; that is 2-3 tonnes P equivalent per day per million of population. (In rural localities where there is no sewerage collection system, these phosphate loadings are still discharged back into the environment via septic tanks. They find their way back into the surrounding soil and natural drainage systems, making their contribution to the pollution of lakes and streams too!).

According to estimates made for the UK, an average of 1.2 g P/capita/day enters urban sewage systems from the diet, with a further 1.3-1.8 gP/capita/day from other household activities, including contributions from household detergents.² Recent reductions in the phosphate content of household laundry detergents have been partially offset by increases from the use of domestic dishwasher detergents. It would seem unlikely that domestic discharge of phosphates into sewage will ever fall far below 2g/capita/day in developed countries such as those of the European Union.

Impact of detergent phosphates

For almost 20 years, environmentalists have labelled detergent phosphates as the major cause of eutrophication in lakes and other bodies of freshwater, and legislation has been introduced in many countries to prevent their use in detergent formulations.

Much of the adverse opinion expressed against the use of phosphates and polyphosphates in detergents, however, has now been called into question by serious scientific research from reputable sources.

In 1994, the Netherlands Organization for Applied Scientific Research (TNO), Institute of Environmental Sciences, published the results of research showing that the use of phosphate-free detergents gives no improvement in surface water quality, and leads to eutrophication that is in many cases worse than that experienced when phosphate-based detergents are used. The main reason for this is that the alternative non-phosphate detergent ingredients were found to be so toxic that they kill the vital zooplankton that feeds on algae and phytoplankton in naturally balanced freshwater systems. TNO's research concluded that there is "no environmental reason to exclude STPP-based detergents from a green product nomination".³

In 1995, a three-year study in England's Lake District was reported demonstrating that phosphates could be used beneficially in the rehabilitation of lakes that had been "killed" by acid rain. Phosphates have well-known buffering properties, and additions of sodium phosphate were found to be far more effective in controlling the pH of acidified lakes than the more widespread practice of using lime neutralisation.⁴

Phosphates from wastewaters as a potential resource

Whatever the rights and wrongs, or the "pollution" arguments of environmentalists, it is clear that urban wastewaters and sewage contain concentrations of phosphate that would represent significant tonnages of valuable plant nutrient if they could be recovered economically. At average loadings of 2 gP equivalent/capita/day (dietary and non-dietary components combined), around 5 tonnes of P₂O₅ equivalent is discharged each day to municipal sewage systems per million of population. Thus, for the European Union as a whole, the total might amount to more than 2,000 tP₂O₅/day. Even if all non-dietary phosphate were eliminated, the remaining phosphate loadings in sewage would probably still be greater than half this figure.

CEEP argues that, apart from Finland, there are no commercial phosphate rock deposits in the European Union, and the phosphate content of urban wastewaters could represent a valuable resource. Furthermore, EU legislation on water quality the EU Urban Wastewater Treatment Directive (91/27/EEC) which sets out limitations to both phosphorus and nitrogen concentrations in wastewaters, will also prohibit disposal of sewage sludges at sea after 31 December 1998. Other directives also set standards for alternative disposal methods for sewage sludge, which include landfill and incineration (see *Table 1*).

Table 1: Requirements of Urban Wastewater Treatment Directive for sensitive waters

Parameter	Population equivalent (p.e.)	Concentration (mg l⁻¹)	Minimum reduction (%)
Total phosphorus	10,000-100,000	2	80
	>100,000	1	80
Total nitrogen	10,000-100,000	15	70-80
	>100,000	10	70-80

TABLE NOTES AND KEY:

- ¹ Reduction in relation to the influent load. A minimum reduction of 75% may apply if all urban wastewater treatment plants in the local area achieve this level.
- ² Total nitrogen means: the sum of Total Kjeldahl Nitrogen, aka TKN, which is the sum of organic N, ammonia (NH₃), nitrate (NO₃) and nitrite (NO₂).

The practice of recycling sewage sludge to farmland appears to be in decline, and the use of secondary treatment of sewage sludge to reduce its biological oxygen demand actually results in practically all the phosphate contained in the original sewage being solubilised in the wastewater. But wastewaters containing more than 1-2 mgP/litre cannot be discharged into "sensitive waters." It is against this background that the CEEPs study into phosphate removal and recovery was undertaken.

The study is a comprehensive review of available technology spanning the whole ambit of phosphate removal and recovery from wastewaters (from the biological processing of sewage sludge for recycle on the land), right through to processes that yield isolated phosphate chemicals for recycle or re-use.

Sewage treatment and phosphate removal

The treatment of sewage can consist merely of the primary sedimentation of the solids, but nowadays usually also involves secondary treatment (aeration), so that the biological oxygen demand is reduced sufficiently for wastewaters to be discharged into natural bodies of water. The sedimented sludge from primary treatment retains much of the phosphorus in organic form, and can be usefully applied to the land if contaminants, such as heavy metals, are not present at too high a level. The aeration process, however, transforms practically all the phosphorus into the water soluble orthophosphate form. Typical wastewaters from such treatments can contain 10-25 mgP/litre, which is far in excess of the EU wastewater directive for sensitive waters.

Phosphates in solution can be precipitated by the addition of flocculating reagents, such as iron and aluminium salts. The degree of phosphate removal depends on how these are added (see *Fig. 1* and *Table 2*).

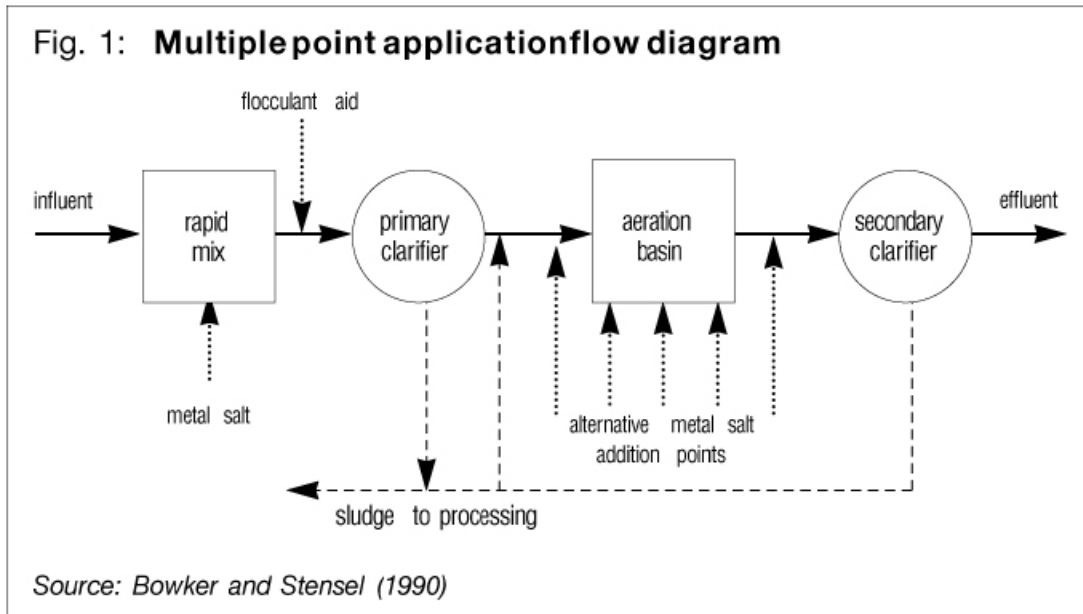

Table 2: Cost estimates for phosphorus removal by mineral addition

Flow rate (m ³ d ⁻¹)	Chemical	Chemical dose ¹ (mg l ⁻¹)	Installed equipment cost ^{2,3} (\$)	Annual O&M cost ^{2,4} (\$year ⁻¹)
3,785	Liquid Alum	65	75,600(d)	44,000
	Liquid FeCl ₃	50	65,700	40,000
37,850	Liquid Alum	65	122,800	328,000
	Liquid FeCl ₃	50	116,800	369,000

TABLE NOTES AND KEY:

- Alum as Al₂(SO₄)₃·14H₂O. Dosed to meet effluent TP = 1 mg l⁻¹
- Cost estimates from EPA report, updated to 1987.
- Includes chemical storage, transfer, feed, pipes and mixing basin. Doesn't include sludge handling.
- Includes O&M for labour, power, maintenance materials & chemicals. Chemical costs of iron = \$0.20 kg⁻¹, and aluminium = \$0.17kg⁻¹. Source: Bowker and Stensel (1990)

If the reagents in a two stage sewage treatment system, involving both primary and secondary treatment, are added prior to primary sedimentation, typically 70-90% of the phosphorus is removed into the sludge. When added at several points in the treatment system, the removal can be 80-95% or more. The phosphate thus removed is separated along with other precipitated impurities and is normally amalgamated with the rest of the sewage sludge from the treatment process, for disposal. The sludge mass can increase up to 50% and its volume up to 150% depending on the chemicals used and the nature of the whole range of impurities present in the water-soluble phase.

Such methods can consume considerable volumes of chemical reagents (precipitants and flocculants) and, owing to the cost, have been superseded to a large extent in recent years by biological phosphorus removal systems (BPRs), which are cheaper to operate but also remove the phosphate to the sludge. Such methods rely on the fact that activated sewage sludge that has been subjected to vigorous aeration can take up phosphate beyond that required for its microbial activity.

In a conventional activated sludge plant, phosphorus removal to the sludge can be 20-40% of that present. In BPR processes, the increase in phosphorus removal depends on the biodegradable chemical oxygen demand in the sludge (see Fig. 2).

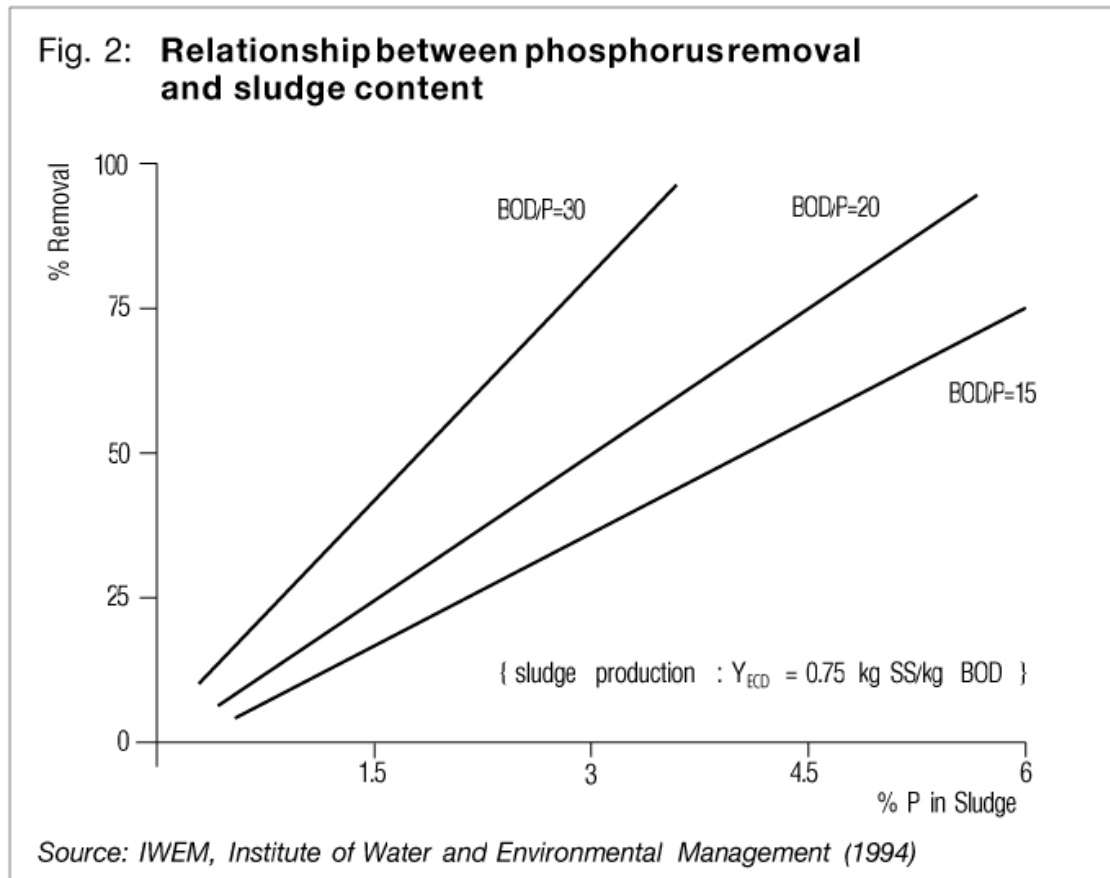

A number of variations on the basic technology exist, and combinations involving both chemical and biological treatments are possible. Some have been developed with retrofitting in mind, while others involve combinations of bioreactor systems to replace existing sewage treatment operations.

Processes that use advanced bioreactor systems, including fluid-bed bio-reactors, have also been developed, as well as integrated processes such as the Hypro concept, involving hydrolysis of sludge with sulphuric acid as a key processing step. Invariably, such processes give rise to a wastewater that is substantially phosphate-free, together with a phosphate-enriched sludge, which may or may not have a demonstrably significant agricultural value.

Treatment of sewage sludge

In contrast to past practices, CEEP says that comparatively little sewage sludge is recovered and recycled to farmland nowadays, and that the current trend is for less rather than more sludge to be disposed of in this way. Indeed, CEEPs report observes that effective methods for returning the valuable nutrients contained in urban sewage to the land have largely remained elusive.

Nevertheless, the report does examine technology available for improving the properties of sludge to enhance its handling characteristics as well as its agricultural value, such as the Simon N-Viro composting process and the Swiss Combi drum dryer process.

Figure 3 shows the N-Viro process, which dates back to the 1970s, and involves controlled composting at high temperature (50°C/122°F plus) with alkaline additives (e.g. cement dust and lime), in order to pasteurise the sludge and inactivate pathogens and micro-organisms. A dry "soil" that can be used as a growing medium when mixed with normal soil is the product of the process.

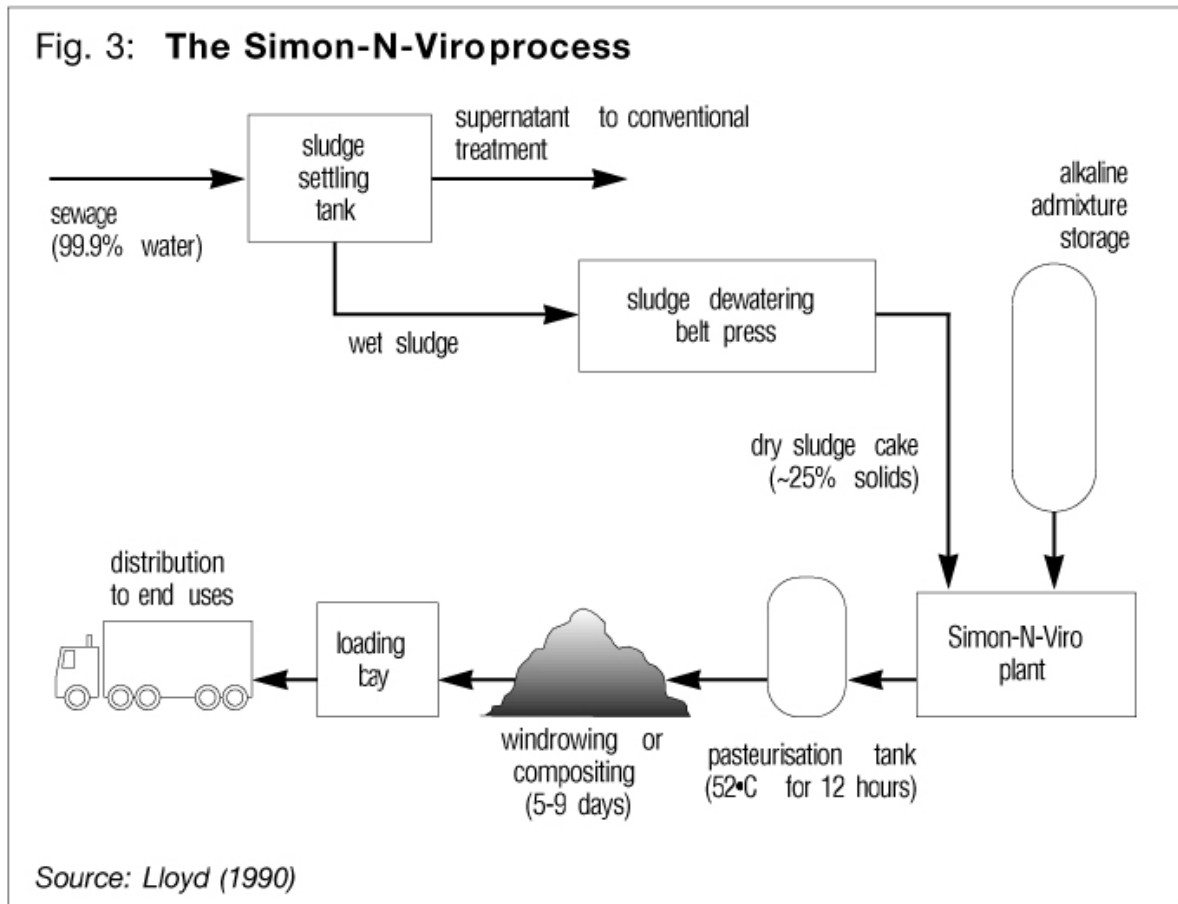

The process is claimed to have the advantage of binding heavy metals present in sewage sludge in an insoluble form, so that they do not leach out to be taken up by crops. However, disadvantages include odour problems (chiefly ammonia) that need to be controlled, as well as uncertain nutrient values. N-Viro has been demonstrated in the USA and was used in the past by Southern Water in the UK, however, this water company has now substituted a different composting process.

The Swiss Combi drum dryer process, shown in Fig. 4, was developed by W. Kunz AG in the 1980s and has been adopted by Wessex Water in the UK in order to comply with EU directives and UK legislation banning the disposal of sewage sludge at sea. Essentially, the process involves drum drying and pelleting of dewatered sewage sludge at 150°C (302°F). Combustion gases at 450°C (842°F), which may be derived from adjacent biogas production, are used to provide heat for the dryer, but it is claimed that up to 70% of the energy used can be recycled, and electrical energy exported to the local grid.

Fig. 4: The Swiss Combi Dryer

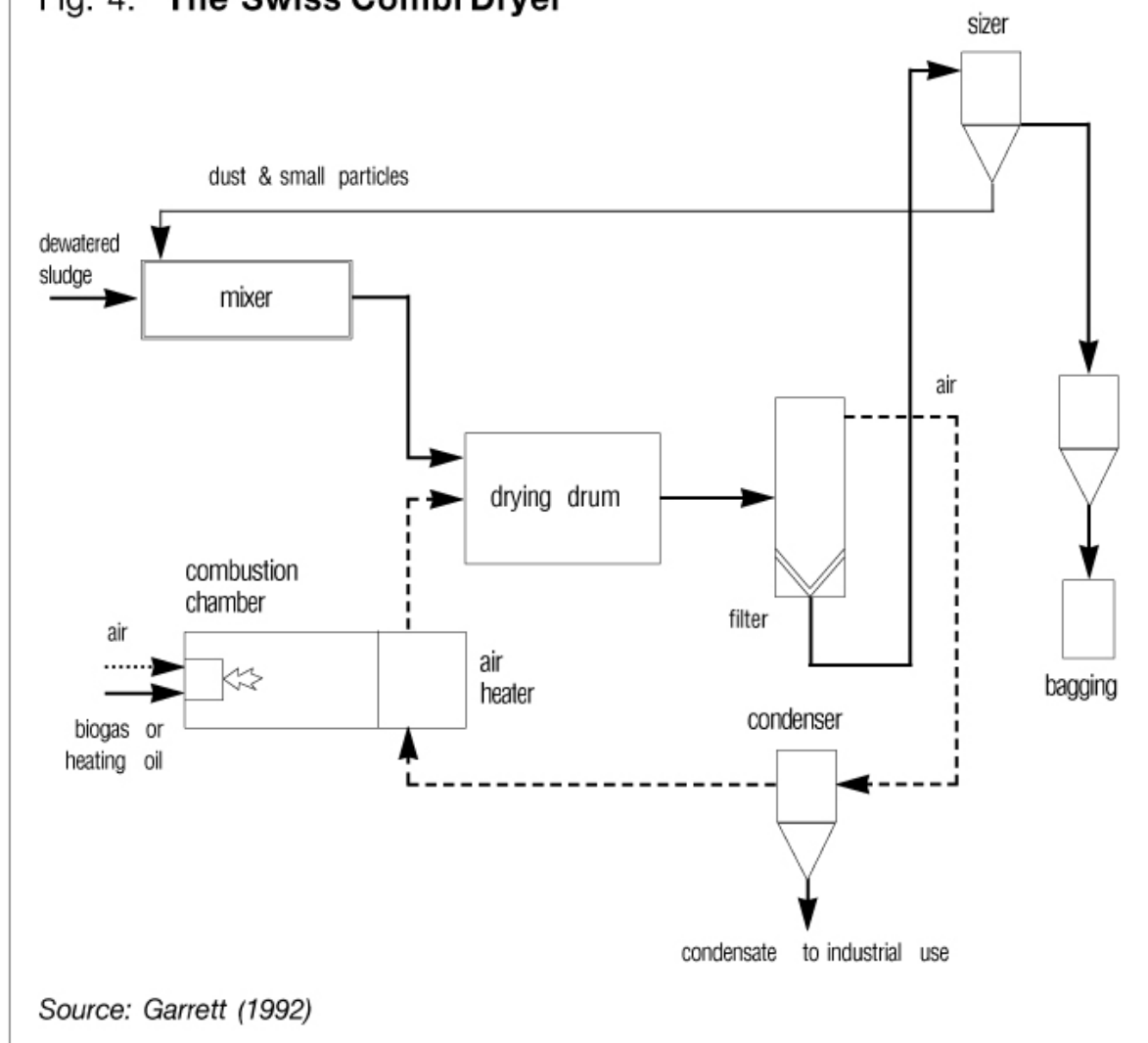

Source: Garrett (1992)

Wessex Water claims that if the process is fired on biogas derived from sewage digesters, then typical operating costs are £50-60 (\$80-100)/tonne of dry solid. The dried product sells for £17-20 (\$27-32)/tonne, but Wessex Waters Avonmouth plant is also able to sell electricity and hot water off-site.

The main objectives of such processes are to sanitise the sludge and improve its handling characteristics, transforming it at low cost into a saleable product. The economics depend crucially on local circumstances, and to date no process of this nature is in widespread use. To recycle phosphorus back to the land on a broader scale, it would appear that other solutions are needed.

Phosphorus recovery

In Japan, limited landfill capacity and stringent regulations governing agricultural re-use of sewage waste have combined to make the incineration of sewage sludge the preferred method of disposal in many cases. Accordingly, this has presented the challenge of recovering phosphorus values from the incinerator ash, and laboratory scale work at Chuo University has shown this to be feasible.

Sludge obtained from a so-called Enhanced Biological Phosphorus Removal (EBPR) system, containing on average 7-10% P on a dry weight basis, is typically dried and then incinerated at 670°C (1238°F). It was found that the phosphorus values contained in the incinerator ash could be leached with water and precipitated using ferric chloride to yield a mixture of ortho- and poly-phosphates, depending on the precise temperature (in the range 30-55°C, 86-131°F) at which precipitation takes place. Although incineration is a potentially high-cost

disposal method for sewage sludge, such a phosphate recovery method may prove to be of interest where no alternative to sludge incineration can be considered.

Other options focus on the prospect for recovering the phosphorus values from sewage treatment wastewaters which, depending on the sewage treatment method, may often contain the bulk of the phosphorus originally present in the raw sewage. Adsorbents such as activated alumina, partially burned dolomite (calcium/magnesium carbonate), and red mud (a residue from bauxite refining in the aluminium industry), have all been shown to be suitable for removing phosphates from wastewaters without the need for other reagents to overcome alkalinity. Aluminium phosphate compounds have dubious value as phosphate fertilisers, while magnesium is a secondary nutrient often added to fertiliser products in any case.

Such processes have the advantage that the phosphate removal step does not lead to additional tonnages of sludge to process or dispose of, since the adsorbed material is not added back to the sludge. However, further processing would probably be necessary to develop a product of sufficient fertiliser value to have good potential for recycle of phosphate to the land.

Useful phosphate products from waste water

Perhaps the best prospect for recycle of phosphates from urban sewage wastewater lies in processes that precipitate discrete crystalline products of reasonable purity, that could be used directly as fertiliser materials or as a substitute raw material in standard phosphate fertiliser production technology.

Several processes of this nature have been developed. Main products are usually either (insoluble) hydroxyapatite, 42% P₂O₅ when pure, or (soluble) struvite, magnesium ammonium phosphate, nominally 8:41:25 N:P₂O₅:MgO if dehydrated, depending on the processing conditions. The analysis of the material being processed, whether (nitrogen containing) sewage sludge or (substantially nitrogen-free) wastewater, for example, its pH and other factors including the precipitants used (i.e. magnesium compounds, caustic soda or lime) all have an effect on the most appropriate product to aim for. Most of the processes do not result in the production of any additional quantities of sludge.

Crystalactor process

Developed by Dutch consulting engineers DHV in the late 1970s, the Crystalactor process has been used commercially in water softening and other water purification applications for some years. For phosphate removal, the process aims to produce calcium phosphate (hydroxyapatite) in a granular form using a fluidised-bed reactor/crystalliser. The phosphate crystallises on seed grains, usually sand (see *Fig. 5*).

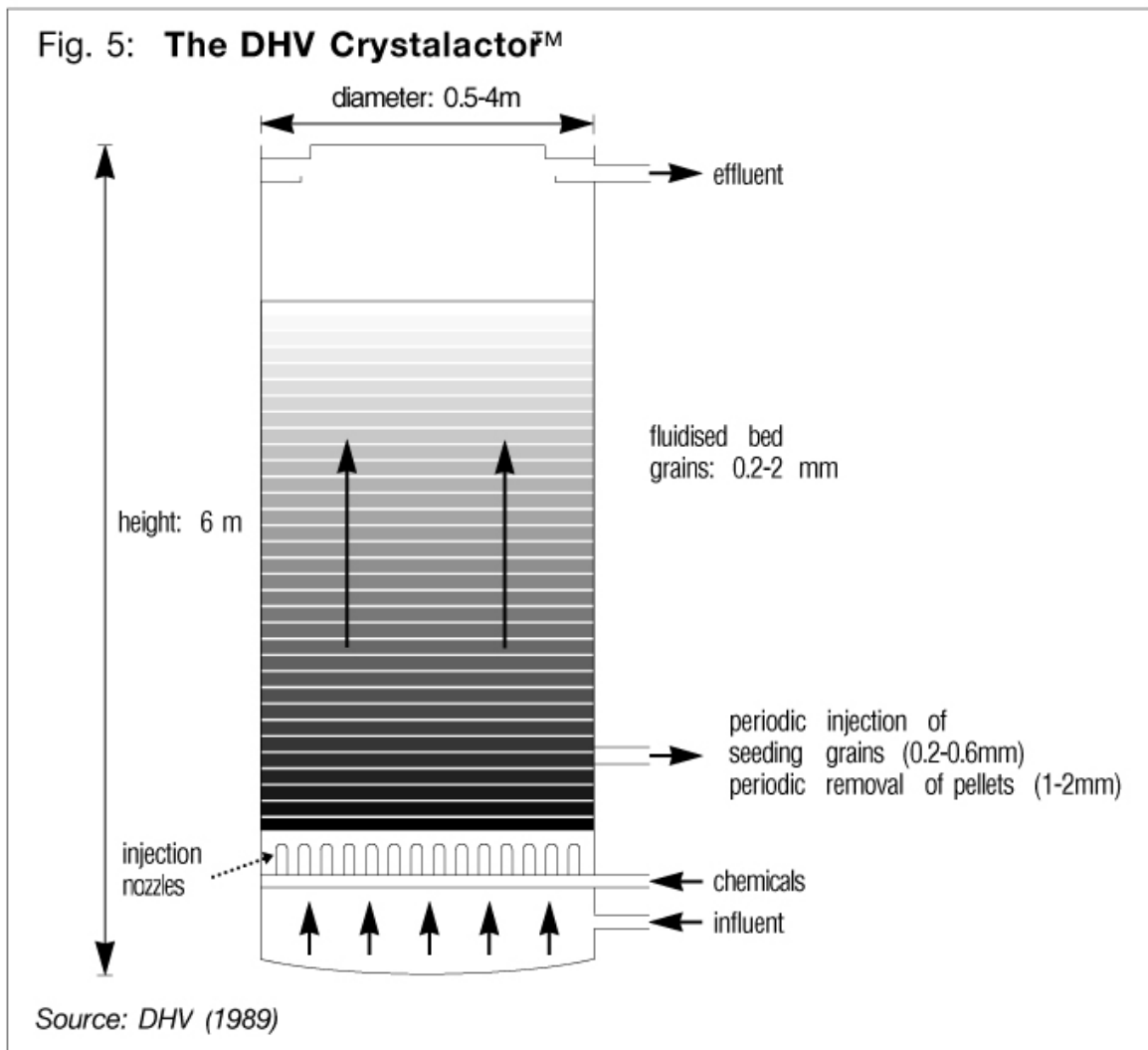

The process involves preliminary degasification (carbon dioxide removal) of the phosphate laden wastewaters with 96% H₂SO₄ sulphuric acid and then crystallisation of calcium phosphate by the controlled addition of lime or caustic soda. It has been found that dosing with caustic soda (OH ions) is often more effective than dosing with lime (Ca ions), since it increases the driving force for the conversion of the phosphate to tricalcium phosphate. In practice, dosing with lime is only necessary in "soft" wastewaters.

A demonstration plant was built at Westerbork, Netherlands, in 1988, where the phosphorus loading (including organic phosphorus) in raw sewage of 16 mgP/litre is first reduced by conventional sewage treatment to 9 mgP/litre. Here, the Crystalactor process reduced the phosphorus loading in the final effluent to less than 0.5 mgP/litre while producing up to 40 tonnes of 2 mm diameter calcium phosphate pellets per year. These typically consist of 40-50% calcium phosphate, 30-40% sand, and up to 10% calcium carbonate. Employing ground pellets as seed materials eventually reduce the sand content, so that a product with higher calcium phosphate content is obtained.

However, with the reduction in use of phosphate-based detergents in the Netherlands, the economics of the basic process have become more questionable. In the mid-1980s, for example, typical P concentrations in raw sewage averaged 15 mg/litre with peaks up to 23 mgP/litre, whereas today the respective figures are 10 mgP/litre and 15 mgP/litre. Installing an additional phosphate enrichment step (such as DHVs Phostrip) can produce enriched wastewater streams containing up to 50 mgP/litre, which results in reduced equipment sizes and better economics for the phosphate removal step (see *Table 3*).

CSIR process

In South Africa, CSIR has also developed a fluidised bed crystallisation column at laboratory scale for removal of phosphate from a variety of influent streams. Phosphate can be removed either as hydroxyapatite or struvite, according to the make-up of the feed stream, and retention times in the range of 3-10 minutes result in over 90% P removal at pH controlled between 8.0 and 9.5.

Struvite crystallisation can occur naturally at sewage treatment works if the right molecular ratio of P:N:Mg exists (roughly 1:1:1). This can cause scaling problems in pipes. CSIR has therefore proposed a process that combines sewage treatment with phosphate crystallisation, such that both hydroxyapatite and struvite can be obtained as crystalline products (see Fig. 6).

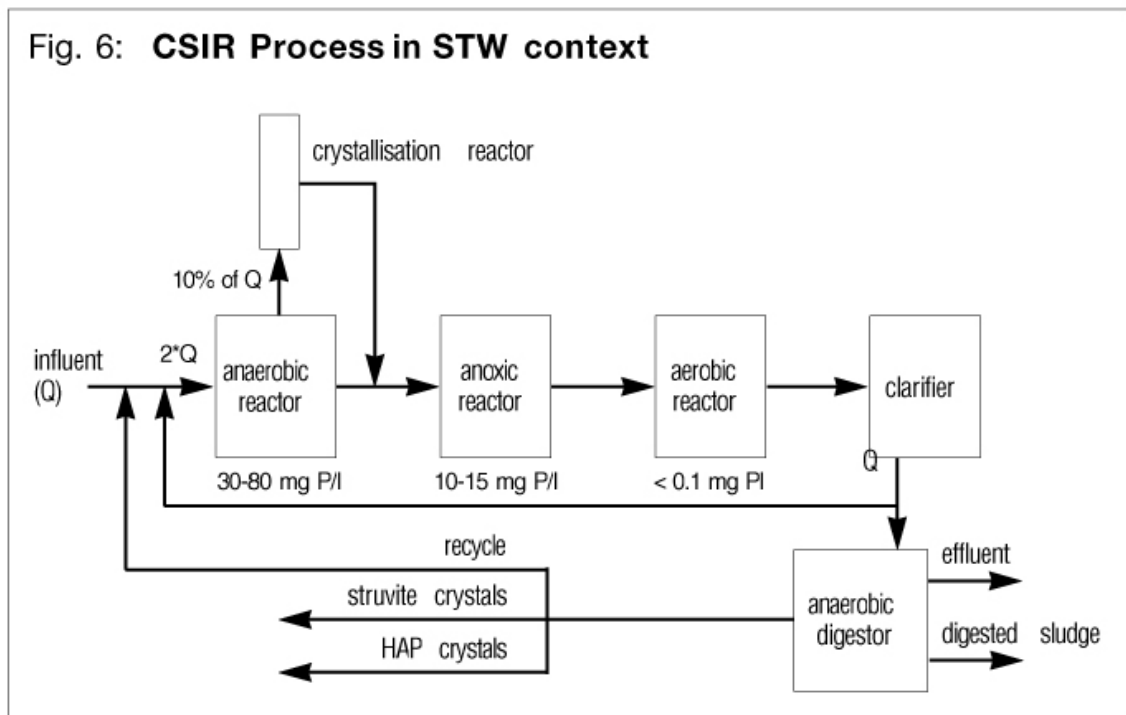

The process claims to be capable of reducing phosphate loadings to less than 0.1 mgP/litre from raw sewage intake containing 30-80 mgP/litre. Conditions for struvite precipitation are optimum at pH above 8.0, while those for hydroxyapatite are best at pH above 9.5.

Kurita process

Using similar chemistry to that in the DHV and CSIR processes already described, Kurita Water Industries, Japan, has developed a process based around a fixed bed crystallisation column. The Kurita process is designed to remove phosphate from the secondary effluent of sewage treatment works using phosphate rock as seed material.

The fixed bed column reactor is packed with 0.5-1.0 mm phosphate rock particles. The secondary effluent passes upward through the column, having been conditioned with the addition of calcium chloride and caustic soda. Hydroxyapatite is precipitated. It is claimed that the residual phosphorus content of the effluent lies below 1.0 mgP/litre. However, it is not clear how the crystals are removed from the reactor.

OFMSW/BNR

A three-stage process that integrates anaerobic digestion of the organic fraction of municipal solid waste (OFMSW), biological nutrient removal (BNR) and phosphate crystallisation, has been developed in a joint research effort by three institutions in Italy and Spain Department of Environmental Sciences, Venice, Department of Materials and Land Science, Ancona, and Department of Engineering, Barcelona.

Solid municipal (food) waste collected from shops and institutional catering establishments, is pulverised and added to primary sewage sludge and co-digested. Anaerobic fermentation of the OFMSW provides fatty acids and other biodegradable compounds that act as a carbon source for efficient BNR. The BNR step operates on the liquid phase, while the solid phase is processed in further anaerobic digesters, receiving the phosphate-enriched liquor from the BNR.

Effluent from this combined treatment has high concentrations of Ca, Mg, PO₄ and NH₄ ions, in a stoichiometry suitable for precipitation of either hydroxyapatite or struvite. Seed grains of sand or quartz assist nucleation of the crystals in either a packed bed or fluidised bed reactor. Typical phosphate concentrations entering the reactor range from 28-81 mgP/litre, and phosphorus removal efficiencies of 52-87% are claimed. At this stage, the integrated technology has only been demonstrated at laboratory scale.

RIM-NUT Ion-Exchange

The RIM-NUT ion-exchange/ precipitation process, developed by Italys Water Research Institute and the University of Bari, removes both ammonia and phosphate ions from wastewater obtained in tertiary sewage treatment. Research was motivated by stringent Italian discharge laws that specify maximum admissible concentrations of 15 mgNH₄/litre (10 mg total N), and 10 mgP/litre for sea outfall or 0.5 mgP/litre for lakes.

Small scale pilot plant tests were undertaken in 1981/2, after which a 10 m³/hr demonstration plant was operated in 1983. The process involves a two-stage ion exchange, using two columns of cation exchange resin and two columns of anion exchange resin, followed by precipitation of the nutrients. The cation exchange removes ammonium ions from the water, while the anion exchange removes the phosphate. Sodium chloride (NaCl) is used to regenerate both the anionic and cationic resins.

The regeneration eluates are fed to a precipitation/settling tank where the Mg:N:P ratio is adjusted to 1:1:1 if necessary by the addition of further phosphate and magnesium salts. Caustic soda or soda ash is then added to precipitate struvite, MgNH₄PO₄·6H₂O, which is settled and separated. Phosphate removal efficiencies greater than 95% were achieved in "closed loop" operation, in line with the level of removal necessary to meet the discharge regulations for lakes. As used, the RIM-NUT process, shown in Fig. 7, was only ever required to process a fraction of the total effluent from the sewage treatment facility at West Bari.

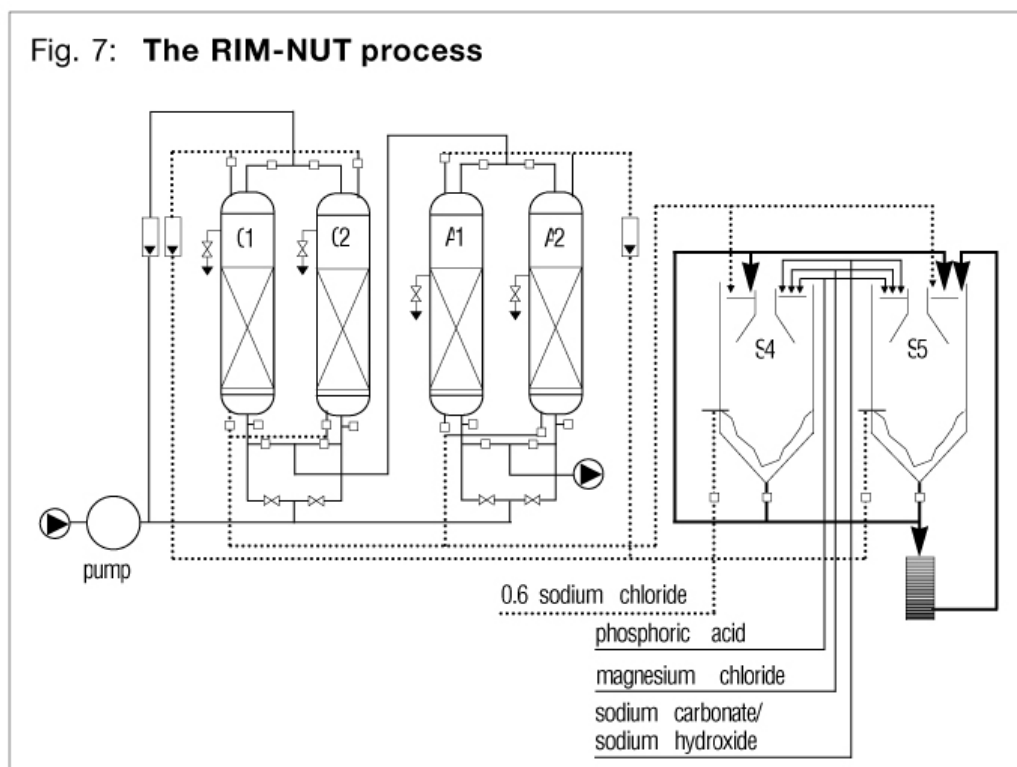

The magnesium ammonium phosphate product consists of more than 93% inorganic material and corresponds to a fertiliser grade of 5:27:15 (N:P₂O₅:MgO). Dehydration at 90°C (194°F) gives an anhydrous product analysing 8:41:25.

Unitika Phosnix process

The Phosnix process developed by Unitika Ltd, Japan, is a tertiary phosphate removal system and is based on the crystallisation of struvite from an enriched phosphate stream.

Secondary sewage digester effluent is fed to the base of an air-agitated reaction tower, where caustic soda and magnesium chloride are added to arrive at the correct molar ratios and pH for the magnesium ammonium phosphate to precipitate at ambient temperature. Blown air fluidises the reactor contents so that the crystals have time to grow to a point where they sink as pellets to the bottom of the reactor for removal. Dewatering leaves a product that has a residual moisture content of about 10%, and analyses 5.3:13.3:11.5 (N:P:Mg), compared to 5.7:12.6:9.9 for pure struvite, MgNH₄PO₄·6H₂O.

Phosphate removal efficiencies in the range 88-97% are claimed, on effluent streams ranging from 30 to 905 mgP/litre. Unitika also claim that the sales of the struvite product as fertiliser cover the cost of operating the process.

Sydney Water Board

A phosphate removal system, claiming to produce a crystalline calcium phosphate product from a variety of wastewaters, was developed in the early 1990s by Sydney Water Board, Australia. This process, which is still understood to be at the laboratory scale, also involves crystallisation in an agitated bed reactor.

Wastewater is first decarbonated (if necessary) by aeration in the presence of added sulphuric acid. Additional calcium ions are then added in the form of gypsum. A moving bed of fine magnesia particles in the reactor serves to seed the crystallisation, so that product size crystals can be grown in a retention time of 0.5-2.0 hours.

The dosage of calcium ions added as gypsum is controlled in order to achieve a phosphorus concentration in the process effluent of less than 0.3 mgP/litre, whatever the phosphate loading of the influent wastewater may be.

The process is said to be equally suitable for treating effluents from primary, secondary or tertiary sewage treatment, and is thus able to deal with wastewaters containing "several hundred" mgP/litre (see Fig. 8).

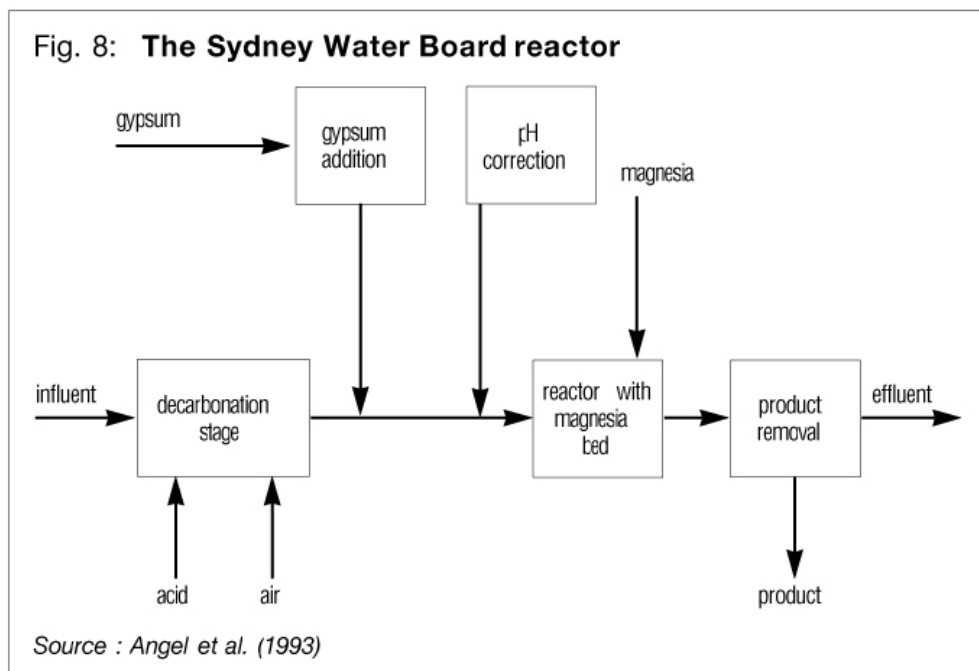

What now?

For such phosphate recovery processes to succeed on a wide enough scale to affect the "sustainability" of the industrial/agricultural phosphate cycle, both legislative and economic incentives must act in a positive way. The economics of the processes is critical. Cost indicators such as the phosphate recovery levels achievable, the consumption and cost of reagents, the practical need for "seeding" materials at full industrial scale, and the ultimate fate of heavy metals contained in municipal waste will all have an influence on the relative cost and value of the products obtained.

Many of the advanced processes discussed are still at the development stage and it is likely that some practical problems remain to be solved. Furthermore, it has been argued that some of these processes involve what is in effect "alien" technology to conventional sewage treatment practice (rather similar to the "alien" nature of fuel cell technology in power generation, which was discovered over 100 years ago and is only now beginning to be taken seriously! See *Nitrogen* magazine).

CEEP says that the barriers to the introduction of such techniques are not fundamentally technical, but stresses that imagination and leadership are required for them to be accepted widely. Who is likely to provide these? For the phosphate fertiliser industry, what incentives are there to use these recovered phosphate products as they come available, and how will they be marketed for their plant nutrient value?

It is also possible that current legislative pressure to reduce phosphates progressively in wastewaters is actually working against the economics of recovery of what is left behind. Is there possibly a case for returning to the use of phosphates in detergents, and phasing out phosphate precipitation in sludge, so that the phosphate loadings in wastewaters are increased to the point that they are economically recoverable? Is it just possible that an incentive of this kind may bring the imagination and leadership that CEEP refers to? n

References

1 "Phosphorus removal and recovery technologies", produced by Environmental and Water Resource Engineering section, Imperial College of Science, Technology and Medicine, London, for Centre Européen d'Études des Polyphosphates EV, Selser Publications, London, 1997.

2 Foy, R.H., Withers, P.J.A.: "The Contribution of Agricultural Phosphorus to Eutrophication", Fertiliser Society Proceedings, No. 365, April 1995. (Described in brief detail *Phosphorus & Potassium* 198)

3 "STPP the Green Choice?", *Phosphorus & Potassium*, **195**, pp. 23-26, (Jan/Feb 1995).

4 "More good press for phosphates", *Phosphorus & Potassium*, **200**, pp. 2, (Nov/Dec 1995).

Phosphates recovery for recycling from sewage and animal wastes

The article originally appeared in the Journal:
Phosphorus & Potassium, Issue No: 216
(July-August, 1998)

Reproduced with the permission of British Sulphur Publishing

Alone amongst organisms modern man has forgotten the importance of conserving and re-using phosphorus. Estimates of the Earth's phosphate reserves vary considerably but most commentators expect them to last little more than one hundred years. Moreover, it is certainly the case that the highest quality reserves are being depleted rapidly and the way we currently use phosphate does not accord with the principles of sustainable development. The opportunity exists to reverse this trend via the development of effective sewage and animal waste treatment technologies which facilitate the removal of phosphorus from these waste streams into a form suitable for recycling by the phosphate industry.

*John Driver, Manager, Business Planning and Environment, Albright & Wilson, Warley, UK, looks at the issues and current developments in this field, which were the subject of the first **International Conference on the Recovery of Phosphates for Recycling from Sewage and Animal Wastes**, organised by the Centre Européen d'Etudes des Polyphosphates (CEEP), held at Warwick University in the UK on 6-7 May, 1998.*

Why should anyone bother about phosphorus recovery?

Historically, phosphate has been inexpensive and seemingly inexhaustible. Its dramatic effect on soil fertility and hence agricultural production has ensured that its use has been liberal even profligate. Phosphorus addition to soils in Europe has, for many years, far exceeded agronomic requirements with the agricultural community regarding phosphate fertilizer addition as an insurance policy: *it costs very little, will not do any harm (to the crop) and may just do some good.*

With such a large amount of phosphate in the Earth's crust, why should this be a concern? Even making no allowance for global population increase, phosphate reserves are being rapidly depleted. Opinions vary concerning the lifetime of known exploitable deposits yet at present extraction rates (around 40 million t/a P₂O₅) today's reserves are unlikely to last much more than one hundred years.

Perhaps, like petroleum, our view of what is, or is not, commercially exploitable will change with time but what is patently clear to anyone who has worked in the phosphate industry for a number of years is that the quality of commercial phosphate rock is declining inexorably.

This decline reveals itself in a number of ways: the P₂O₅ content of phosphate rock is reducing and the highest grade ores are attracting a premium; beneficiation techniques are being applied to a higher proportion of recovered rocks; the levels of certain impurities, which pose problems in processing (e.g. magnesium), or in application (e.g. cadmium and uranium) are increasing. At the same time, there is growing pressure on the presence of some of these impurities in finished products and on the disposal of impurities extracted during processing or purification (phosphogypsum, fluoride and heavy metals).

For the non-fertilizer sector of the phosphate industry, techniques for the extraction of impurities from green phosphoric acid are at an advanced state of development. But, inevitably, for every Cinderella stream of purified phosphoric acid there is an ugly sister metal-enriched stream. The disposal route for these metals is usually into fertilizers but, with increasing pressure on the cadmium content, this route may not be available indefinitely. For those companies without a fertilizer sink there has been a need to develop alternative technologies to extract and isolate problematic metals in an environmentally safe form: but at a cost. Even without the additional burden of impurities from the purified acid sector, metal levels in fertilizers are under attack.

There are, therefore, three fundamental reasons why the phosphate industry should regard the *status quo* as unsustainable:

I Phosphate rock resources are limited and declining both in quality and accessibility.

I Growth in the world population, particularly in areas with poor soils, will lead to an increase in phosphate fertilizer consumption, only partially offset by a declining rate of use in the historically over-fertilized temperate zones.

I The pressure to remove heavy metals from all phosphate products (including fertilizers) derived from natural phosphate rock will lead to increasing raw material prices and escalating disposal costs.

Seen from another perspective, the widespread losses of phosphorus are a further cause for concern. There is little doubt that nitrate and phosphate levels in European surface waters have risen steadily over the last half century. The mechanisms which control the ecological quality of water are bewilderingly complex and certainly are outside the scope of this article but there can be little doubt that, along with myriad other factors, nutrient levels are central to the processes of eutrophication.

Over three decades there has been persistent pressure on the non-fertilizer sector of the phosphate industry concerning the contribution of detergents to phosphorus levels in rivers and lakes. Increasingly this is also being felt by the fertilizer sector. Even farmers, traditionally a no-go area for environmental legislation, are beginning to feel the heat with respect to balanced fertilization, slurry spreading etc. European water legislation concerning nutrients is diffuse and, perhaps with the exception of the *Urban Waste Water Directive* (91/271/EEC) and the *Nitrates Directive* (which is principally concerned with risks to health), has gone largely unnoticed. The proposed *Water Framework Directive*, currently at an advanced draft state, is intended to gather together much of this disparate legislation into a coherent whole. Looking forward, we should expect to see phosphorus control, probably phosphorus removal, becoming a requirement at all significant sewage treatment works discharging into inland waters. Stricter controls on intensive livestock farming may also become the norm and, as localised manure surpluses pose increasing challenges for disposal, treatment systems and phosphorus removal are likely to feature in future thinking.

Where phosphorus removal is required by law, phosphorus recovery from sewage treatment systems may be an economically attractive alternative. Animal wastes also offer a potentially large source of phosphates for recovery. The technology of phosphate recovery is relatively straightforward and, as well as the value of the recovered phosphorus, there can be significant savings in both treatment costs and in the disposal of the residual sewage sludge.

Just how much phosphorus is out there?

The quantities of phosphorus present in sewage and animal waste are significant compared with the needs of the non-fertilizer sector of the phosphate industry. In the UK around 40 million tonnes of domestic sewage (i.e. organic waste prior to dilution with tap or rain water) is produced each year as well as some 150 million tonnes of farm animal wastes in livestock units. These wastes can be estimated to contain around 45,000 and 200,000 tonnes, respectively, of phosphorus (as P). Together this represents approximately six times the consumption of phosphate products (excluding fertilizers) in the UK. The pattern in other European countries is likely to be broadly similar although the balance between the human and the animal contributions may vary and, on a local or regional basis, may be markedly different.

Realistically, not all of this phosphorus would be available for recovery, Even if practical techniques could be developed, logistic factors, such as the cost of transport and the scale of installations, would make recovery inappropriate. In practice, recycling is likely to be an economic option only in the case of large, geographically concentrated waste streams (sewage from urban areas, intensive livestock units). In rural areas, agricultural sludge or manure spreading will probably always remain the best option for recycling nutrients.

However, in the UK even a conservative estimate of the potential for phosphorus recovery and recycling (50% recovery applicable to 25% of sewage and to 15% of animal wastes) represents half of industrial phosphate demand. Putting this into perspective, fertilizers and animal feeds consume at least five times as much phosphate as industrial applications.

What phosphorus recycling strategies are there?

Spreading of sewage sludge and animal manures onto agricultural land has always been, and will remain, the simplest strategy for recycling nutrients and the importance of this route has been recognised throughout history. Compelling archaeological evidence exists to show that rigid procedures existed for the gathering and re-application of manure (both human and animal) to farmed land. In English monasteries, by the Middle Ages, it was commonplace for contracts, governing the use of monastic lands, to contain a manure clause which permitted the farmer to graze his sheep, take away the wool, take away the meat, but the manure had to stay where it fell: on the field.

Things have changed, however. The growth of cities has resulted in the centres of consumption (and hence, human sewage production) becoming remote from areas of agricultural production. This has led to logistical difficulties in restoring human waste to the land a problem, incidentally, made more difficult with the widespread introduction of sewage treatment. In recent years, the whole practice of sludge spreading has been called into question with pressure on heavy metal content, pathogens, odour, nutrient losses to water etc.

Manure and slurry spreading might seem a comparatively homely and unproblematic practice. But here, too, problems have arisen due to the intensification of livestock production particularly pigs and poultry. This has resulted in large local excesses of manure production, far beyond the capacity of nearby farmland to absorb the output. In such situations, alternative disposal routes have to be found; incineration is amongst the options already being employed.

The excess of nutrients, currently from sewage treatment works but increasingly from animal wastes, will need to be prevented from reaching surface water if quality objectives are to be achieved and maintained. Hitherto, the strategy has been one of phosphorus removal, not recovery and this has been achieved via a variety of methods. In all cases, however, where phosphorus is removed from waste waters it is transferred to sludge, either in an organic form, as in biological phosphorus removal, or as a chemical precipitate: usually in the form of an iron or aluminium salt. The majority of sewage works equipped with phosphorus removal in Europe use chemical precipitation, often simultaneous with secondary biological treatment, where the chemical precipitate is mixed into the organic sludge. Effective phosphorus removal requires higher concentrations of precipitation chemicals than actually combine with the available phosphorus and, without exception, these methods result in a large (around 40%) increase in sludge production. The resulting sludge is of dubious agronomic value and presents its own disposal problems.

Recovery of phosphorus for recycling, rather than its transfer into sewage sludges, may offer economic and environmental rewards for the water industry. For the phosphate industry it holds out the promise of a significant, if only partial, source of sustainable raw material, which is comparatively free from heavy metals. These benefits must be compared with the investment and running costs of phosphorus recovery installations.

Routes to phosphorus recovery

Phosphorus removal by traditional precipitative methods will generally preclude phosphorus recovery for recycling by the phosphate industry. The resulting iron or aluminium compounds are incompatible with technologies currently used in the phosphate industry. They either require excessive energy input, to separate the phosphates from the added precipitation chemicals, or interfere with the industrial process. As a rule of thumb, for either the solvent extraction or electrothermal reduction routes to high purity phosphate compounds, a maximum of 1-2% of iron and aluminium would be considered the upper limit. Incinerated sewage sludge, generated through a precipitation route might easily contain 20% iron (as Fe_2O_3).

A surprisingly large amount of work has been carried out on possible routes to phosphorus recovery. Many of these have never been developed beyond the pilot, or even laboratory, scale but several have been implemented at both demonstration and full scale. In general, these processes isolate the recovered phosphorus in the form either of a calcium phosphate or magnesium ammonium phosphate (*struvite*).

As a preliminary step to generating a concentrated liquid phosphate stream for phosphate recovery, biological phosphate removal techniques look very promising. In a side stream, the nutrient rich sludge can be made to yield a liquor containing phosphorus in excess of 100 mg/l at least a tenfold concentration increase compared with raw sewage, and all achieved isothermally! Such a stream would be particularly appropriate for phosphorus recovery.

Struvite formation as a route to phosphorus recovery

Full-scale struvite recovery processes are already operational or being built in Japan and the Netherlands:

I The DHV Crystalactor® fluid bed process is used in a full scale struvite recovery installation at the AVEBE potato processing plant in the Netherlands (150m³/h).

I The Unitika Ltd (Osaka) struvite precipitation process is already in application at the Ube Industries Sakai plant (industrial waste waters) and is due to be commissioned in September 1998 at the Shimane Prefecture sewage works, Japan (45,000 m³/d).

I The Geochem Research/Delft University Earth Sciences stirred precipitation process produces potassium struvite from 700,000 t/a of calf manure at Putten in the Netherlands (early 1998).

Samples of recovered struvite from two of these units have been examined and are in the form of easily handled granules or crystals with a phosphorus content close to theoretical and with a low heavy metal content (c.f. phosphate rock). Both products were easily filtered (gravity) and were said to require no further drying.

Doubts remain, however, about the value of recovered struvite for the phosphate industry. Whilst struvite undoubtedly has some value as a fertilizer (including its ammonia and magnesium content), it is difficult to imagine how it might be transformed into other phosphate derivatives using any existing technology at the disposal of the industry. There is no reason whatever to believe that struvite could be used in a traditional wet acid route. Whilst it is conceivable that struvite might be capable of processing through the electrothermal reduction route, the presence of ammonia in the molecule would suggest some interesting challenges in furnace feed preparation (e.g. NOX scrubbing) or a radically different process flowsheet.

Nevertheless, struvite remains an intriguing opportunity, if for no better reason than that it forms itself spontaneously in sewage treatment works. It has been described as an accident waiting to happen and may, in theory, be harvestable. The same cannot be said of the other route: calcium phosphate formation.

Calcium phosphate formation as a route to phosphorus recovery

Several pilot and full scale processes have been tested or are already operating in different countries, recovering phosphates from waste water streams through calcium phosphate formation. Samples of recovered materials from several units have been examined. All were pellet-like solids which drain readily to below 5-10% water and can offer 5-15% phosphorus content.

Fluid bed crystallisation installations

I DHV Crystalactors® at the waste water plants of Westerbork (demonstration plant, 12,000 pe), Heemstede (35,000 pe) and (Geesmerambacht (230,000 pe, running since 1994) in Holland.

I Pilot plant developed by DHV and Essex and Suffolk Water (Compagnie Générale des Eaux) at Chelmsford sewage works, UK, 1997-1998.

I Experimental pilot reactor developed and tested for CEEP by Karlsruhe University at Darmstadt Süd sewage works, Germany, 1997-1998.

I Demonstration plant developed at Warriewood, Australia, by Sydney Water (50,000 pe, 1995- 1996).

I Three plants constructed by Kurita, Japan.

Fixed bed precipitation installations

I Mercedes motor car factory at Gaggenau (160m³/h, running since 1998).

The calcium phosphates would appear to be deposited by amorphous precipitation around the seed material, rather than true crystallisation. This is a complex chemical process and neither the chemical nor the physical parameters are fully understood. The chemistry is made more complex because calcium phosphate is not one molecule but potentially a number of different compounds calcium hydroxyapatite, dicalcium phosphate dihydrate, octacalcium phosphate, tricalcium phosphate with different hydration complexes. The solubility and crystallisation

properties of these different molecules vary and the balance between them will modify the overall behaviour of a recovery reactor.

From the phosphate industrys point of view, a recovered calcium phosphate is an ideal form for onward processing as it is indistinguishable, in most respects, from mineral phosphate rock. In some examples of recovered calcium phosphate, residual organics levels have been comparatively high and, untreated, this would pose problems for the wet acid route. A simple calcining step as employed on many natural rocks may need to be employed. For the electrothermal reduction route a high residual organics level should pose no problems.

The economic case for phosphorus recovery

The economics of the recovery of phosphorus are not determined, in the main, by the value of the recovered phosphate. On the whole, the economic boundary conditions are defined by the cost of sludge disposal (incineration is more costly than landfill or agricultural spreading) where phosphorus recovery will normally result in reduced sludge production, and the competing costs of phosphorus precipitation chemicals (iron or aluminium salts versus lime). Given a choice, the water industry will generally adopt the cheapest available option which can consistently meet regulatory requirements. A great deal of further work needs to be done in the development of a robust economic model but the following conclusions can be drawn:

I Where agricultural spreading is possible, this will always be the cheapest method of nutrient recycling.

I Phosphorus recovery will only be viable where phosphorus removal is mandatory; it is never likely to compete with alternative sewage treatment methods where a lower level of treatment is permitted.

I Application of the EC Directive on the *Treatment of Urban Waste Waters (91/271)* will significantly increase the number of sewage works where recovery might be considered in the years ahead.

I Sewage sludge disposal options and costs, including investment and running costs for thickeners and digesters will be the decisive variable in the economic equation.

I The scale of installations and collection costs for recovered phosphates mean that phosphorus recovery is most likely to be attractive in medium to large sewage works.

I Phosphorus removal will be more easily integrated into biological P-removal systems or in sewage works where phosphorus removal has not yet been installed.

I Phosphorus recovery can facilitate nitrogen removal, via struvite, and is more easily integrated into plants fitted with nitrogen removal.

I Phosphorus recovery may, under certain circumstances, offer the water industry a removal and disposal route for heavy metal contaminants.

I Higher waste water phosphorus contents will render recovery more attractive.

I The phosphate industry will have to evolve and modify its structure in order to establish a stable market for recovered phosphate products.

I Although there is no conceivable health risk from industrial recycling of phosphates from sewage (no pathogen can possibly survive the pH and temperature conditions of the chemical processes used by the phosphate industry), this does not eliminate the possibility of adverse public reaction to the concept of recovering ingredients from sewage and animal wastes for uses such as detergents, food additives, animal food supplements. This will have to be addressed.

Redefining the phosphate industry

The use of recovered phosphates, produced in appropriate chemical forms, should not present a processing problem for the phosphate industry. It would, however, necessitate a major redefinition of the industrys structure and logistics. The European phosphate industrys structure has increasingly moved towards a small number of large production plants. There is only one remaining phosphorus furnace site in Western Europe (Vlissingen,

Holland) and less than a dozen phosphoric acid plants (phosphoric acid is more commonly imported from production plants situated alongside the phosphate rock mines). In the long term, the use of small, diffusely produced quantities of recovered phosphates would necessitate restructuring the phosphate industry. Small local production units and appropriate stocking, grouping and transport systems may be needed.

In the short term, to get recovery started, it may be more appropriate for recovered products to be recycled locally, via small scale manufacture, into relatively simple fertilizers for agricultural or horticultural use.

Where do we go next?

As well as the further work on the economic aspects of recovery, a number of research priorities have been identified including: a better understanding of chemical and physical reaction conditions which promote crystallisation of phosphates; a clearer picture of the segregation of heavy metals in sewage treatment regimes; the role of organic materials in precipitation or crystallisation processes; the role of different seed materials (sand, calcite) in promoting recovery; a better knowledge of the solubility phases of different calcium phosphates; the agricultural value of struvite and the need to study its dissolution behaviour (nutrient release) in soils and accessibility for crops; a better understanding of the conditions for nucleation and growth of struvite under real sewage treatment works conditions.

More important than all of these, however, is the need to create a will to make phosphorus recovery happen.

The non-fertilizer phosphate industry is convinced that the future lies in phosphate recycling and considers that within a decade up to 25% of phosphates used in detergents and other high-grade applications could be recovered from sewage and animal wastes. But the industry cannot make this happen on its own. A partnership is required between the industry and the water treatment sector to begin to recover and, just as important, begin to create a market for recovered phosphate materials. Above all, government involvement: both national and European, is needed to provide the leadership and the policy stimulus, to make phosphorus recovery a reality. n







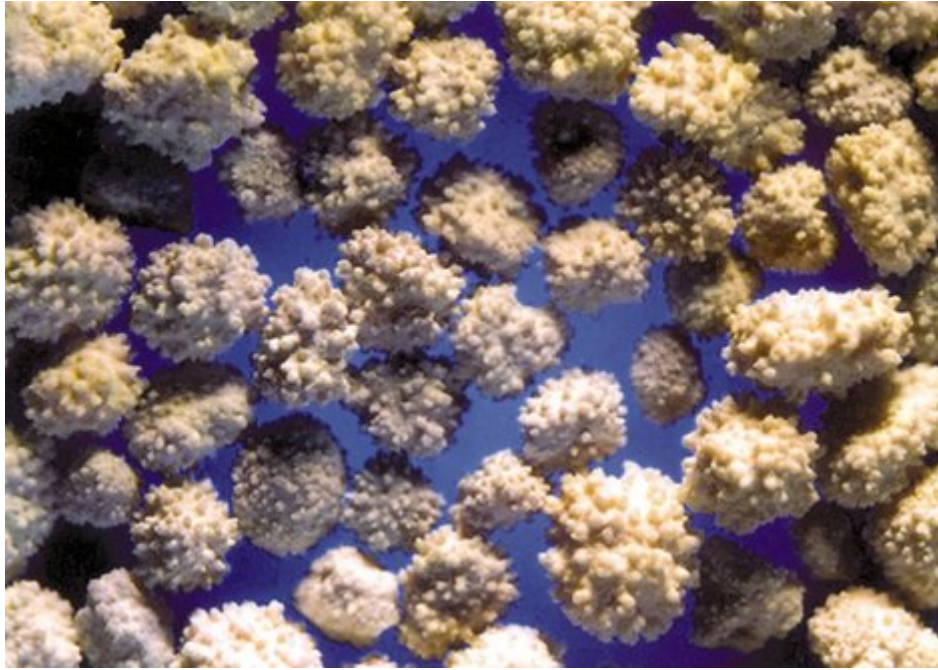

Phosphate recovery installations (from top) at Geestermerambacht municipal waste water treatment plant. Edam, Holland; Warriewood sewage works, near Sydney, Australia; and Shimane Prefecture sewage works. Osaka, Japan. (bottom): Recovered phosphate pellets (magnified).

John Driver
Albright & Wilson UK Ltd.
P.O. Box 3, 210-222 Hagley Road West
Oldbury, Warley
West Midlands, B68 0NN
john_e_driver@albrw.com

PROGRAMME

INTERNATIONAL CONFERENCE ON PHOSPHORUS RECOVERY FROM SEWAGE AND ANIMAL WASTES Warwick University, UK. 6th & 7th May 1998

Introduction

The European phosphate industry is looking at the potential for **recovering the phosphate values of sewage treatment works effluent and animal wastes** as a sustainable raw material resource.

Increasingly, municipal wastewater treatment plants are required to remove phosphorus from their effluent, often at significant additional cost. Recovery, as opposed to removal of phosphorus, offers potential benefits to the water industry, where the recovered phosphate would have a market value, and where the recovery technologies also result in a **reduction of sludge production**. The phosphate industry also perceives benefits from applying recovery technologies. The availability of a recycled raw material addresses some of the industry's resource depletion issues: although phosphate reserves remain substantial, the highest quality phosphate rock deposits are being depleted rapidly. Natural phosphate rock also carries a significant burden of heavy metals that the phosphate industry has to remove and dispose of safely - an increasingly costly activity. In comparison, pilot tests have shown that **phosphate can be recovered from waste water and animal wastes in a comparatively pure form**.

CEEP's Research Programme

Through the Centre Europeen d'Etudes de Polyphosphates (CEEP), its joint research fund, the phosphate industry has embarked on a research programme aimed at **developing processes** for the recovery and recycling of phosphate.

In order to help define its own research priorities CEEP sponsored a number of projects during 1996 and 1997 aimed at establishing what work had already been done in the area of phosphate recovery and what approaches might produce promising results. As a result of these scoping studies CEEP intends to launch new research aimed at understanding the underlying processes which take place during the recovery of phosphate and which might lead to the development of viable recovery processes. In particular, we have identified **the crystallisation of calcium and magnesium phosphates** (including struvite) as phenomena where a better understanding of mechanisms, kinetics and other factors would greatly advance the development of such processes.

Conference Objectives

This conference aims to facilitate a better understanding of the chemical and biological processes which will contribute to the development of sustainable recovery techniques and also to examine the **economic and industrial context** necessary for viable P-recovery.

On the technical side, the conference will look at the limiting physicochemical and biological conditions for the nucleation and growth of the various recoverable crystalline forms of calcium phosphates and of struvite, in order to identify areas that could benefit from further research.

The conference will also seek to **identify the kinds of sewage or animal waste treatment installations where phosphate recovery might be viable** and to assess the steps which need to be taken before phosphate recovery can be more widely introduced.

The long-term objective is to **initiate contacts and discussion likely to lead to industrial research and development of phosphate recovery**, and to identify opportunities for cooperation in this area between the **water and animal waste industries, public authorities** and the **phosphate industry**.

Wednesday 6th May 1998

10h00 - 10h30: Registration, access to hotel rooms, coffee

10h30 - 12h15: Why recover phosphates, where from and how?

10h30 John Driver (CEEP) - Albright & Wilson (UK)
Welcome and introduction : the objectives for this conference
Sustainable development : why does the phosphate industry care?

10h50 Dees Lijmbach (CEEP) - ThermPhos International (Holland)
In what forms can the phosphate industry handle recovered P as a raw material?

11h05 Dr. G. Morse - Imperial College of Science and Technology London (UK)
Overview of key pathways for phosphate recovery

11h30 Questions and discussion

12h00 Lunch

Wednesday 6th May 1998

13h30 - 16h45 - Two parallel sessions : Economic and technical perspectives for P-recovery

Session A: Economic perspectives:

Chairperson: Jean-Carlos Gomez, Rhodia Chemicals (France)

13h00 Ingrid Steen (CEEP) - Kemira Kemi AB (Sweden)
Phosphate rock : a non renewable resource

13h20 Dr. John Upton - Head of Technology and Development - Severn Trent Water (UK)
Nutrient removal in the UK - now and in the future

13h45 David Edge - Regional Biosolids Manager, Anglian Water (UK)
Perspectives for nutrient removal from sewage and implications for sludge strategy

14h10 Discussion

14h30 Coffee break

14h45 Dr. Phil Hobbs - Institute of Grassland & Environmental Research (UK)
Animal wastes as a potential source of recoverable phosphorus

15h10 Dr. Lilliana Moldenado - CH2MHill (USA)
Phosphate recovery - an economic assessment

15h40 Prof. Hermann Hahn - Institute of Aquatic Environmental Engineering, Karlsruhe (Germany)
Phosphate recovery pathways -economic aspects

16h10 Discussion and conclusions

16h45 Coffee break

Wednesday 6th May 1998

13h30 - 16h45 - Two parallel sessions : Economic and technical perspectives for P-recovery

Session B: Technical solutions for P-recovery

Chairperson: John Godber, Albright and Wilson (Canada)

13h00 Dr. Ir. Marc van Loosdrecht - Delft UT/Kluyver Institute for Biotechnology (Holland)
Biological approaches to phosphorus concentration as a preliminary step to P-recovery

13h25 Dr. Alan House - Institute of Freshwater Ecology, River Laboratory - NERC (UK)
The physico-chemical conditions for calcium phosphate crystallisation

13h50 Dr. Nic Booker - CSIRO (Australia)
Struvite formation in waste water treatment plants: an accident waiting to happen?

14h15 Discussion

14h30 Coffee break

14h45 Working experiences of P-recovery:

Prof. Olaf Schuiling - Institute for Infrastructural, Hydraulic and Environmental Engineering, Delft (Holland); Alexandra Andrade - Institute of Earth Sciences, Utrecht (Holland)
A full scale plant for recovery of struvite from calf slurry

Mr. Simon Gaastra - Geestmerambacht Sewage Treatment Works (Holland)
Phosphate recovery at Geestmerambacht Sewage Treatment Works

Mr. E. Antusch - Institute of Aquatic Environmental Engineering, Karlsruhe (Germany);
Mr. W. Steckel - Darmstadt-Sud Sewage Works (Germany)
A pilot crystallisation reactor for recovery of calcium phosphate financed by the CEEP

Mr. Hideo Katsuura - Unitika Ltd (Japan)
P-recovery from sewage by a granular forming process.

16h00 Questions and discussion

16h45 Coffee break

Wednesday 6th May 1998

16h45 - 17h00: Coffee break

17h00 - 18h15: Three parallel workshops covering:

- P-recovery from animal waste
- calcium phosphate crystallisation
- struvite recovery

Each workshop will establish its own priorities in terms of topics of discussion with the aim of drawing up proposals to put to the conference on Thursday morning. Subjects for consideration will include: ways forward for the future, subjects of research, areas for development projects.

P-recovery from animal waste

Chairperson: Dees Lijmbach (CEEP), ThermPhos (Holland)

Introductory ideas from:

Philip Haygarth, Institute of Grassland & Environmental Research (UK)

Perspectives for recovering P from animal wastes: how much is there and how accessible is it?

Mr Leo van Ruiten - an Ruiten Adviesbureau (Holland)

Overview of possible pathways for recovering P from animal wastes

Mr Henri-Jean Caupin - Elf Atochem and Grande Paroisse (France)

On-site separative flocculation and filtration system (Ecoliz) which concentrates 80% of P from pig wastes to a solid cake

Calcium phosphate crystallisation

Chairperson: John Godber, Albright and Wilson (Canada)

Introductory ideas from:

Mr. Robert Angel - Process and Industrial Chemists consultants (Australia)

Magnesium and calcium phosphate recovery from sewage treatment effluent: what seems to work and what doesn't?

Dr. Dietfried Donnaert - Institute for Technical Chemistry, Karlsruhe (Germany)

Competition between carbonate and phosphate at high pH: implications for recovery processes

Jonathan Strickland - Innovation Technologist, Anglian Water (UK)

Perspectives for P-recovery offered by enhanced biological P-removal

Struvite recovery

Chairperson: Prof. Schuiling, Institute for Environmental Engineering, Delft (Holland)

Introductory ideas from:

Rachel Harding - Imperial College London (UK)

Overview of current technologies for struvite recovery

Steve Williams, Thames Water (UK)

Adapting strategies for avoiding struvite build-up problems in plants and transforming them into strategies for recovery

19h00: Dinner

Thursday 7th May 1998

8h30 - 9h15: Continuation of workshops

9h15 - 10h30: Plenary session:

presentation of conclusions of the two parallel sessions and discussion of questions raised by the three workshops by their chairpersons

10h30 - 10h45: Coffee break

10h45: Presentation of priorities and research proposals identified by each workshop

Questions and discussion

12h00: Final conclusions: John Driver

12h15 - 13h30: Closing lunch

List of papers and posters presented at the conference

Phosphate Recovery An Economic Assessment. *Glen Daigger, CH2M Hill USA*

Perspectives for P Recovery offered by Enhanced Biological P Removal. *Jonathan Strickland, Anglian Water UK*

Role of Biological Processes in Phosphate Recovery. *Marc van Loosdrecht, Delft University of Technology, Holland*

Nutrient Removal in, the UK Now and in the Future. *John Upton, Severn Trent Water UK*

Perspectives for Nutrient Removal from Sewage and Implications for Sludge Strategy. *David Edge, Anglian Water UK*

The Phostrip Process, biological removal of Phosphorus from waste waters. *Erich Kaschka, Posch and Partners Consulting Engineers, Innsbruck, Austria*

The Physico Chemical Conditions for the precipitation of Phosphate with Calcium. *Alan House, UK Institute for Freshwater Ecology*

Full Scale Phosphate Recovery at Sewage Treatment Plant Geestmerambacht, Holland. *Simon Gaastra, Uitwaterende Sluizen Waterboard, Edam, Holland*

Crystallisation Process enables Environmentally Friendly Phosphate Removal at Low Costs (presentation of the DHV crystallisation technology and operating experience). *Andreas Giesen, DHV Water BV, Amersfoort, Holland*

Removal of Phosphate from Sewage as Amorphous Calcium Phosphate (presentation of the Warriewood demonstration plant and other research). *Robert Angel, Process and Industrial Chemists consultants, Australia*

Elimination of Phosphorous from Waste Water by Crystallisation (presentation of Gaggenau full scale industrial P removal plant and experimental results). *Dietfried Donnert, Karlsruhe Research Centre, Germany*

Pellet Reactor Pilot Trials for the Chelmer Augmentation Scheme (pilot calcium phosphate P recovery plant). *Gabriella Giuffre and Jason Ringrose, Essex and Suffolk Water UK*

Struvite Formation in Wastewater Treatment Plants : an Accident waiting to Happen. *Nic Booker, CSIRO Australia*

Adapting strategies for avoiding Struvite build-up in plants and transforming them into strategies for Recovery. *Steve Williams, Thames Water UK*

Phosphate Recovery from Sewage by Granule Forming Process (full scale struvite recovery from a sewage works at Shimane Prefecture, Japan). *Hideo Katsuura, Unitika Ltd, Osaka, Japan*

Recovery of Struvite from Calf Manure (full scale plant at Putten, Holland). *Olaf Schuiling and Alexandra Andrade, Utrecht University, Holland*

The Feasibility of Recovering Phosphate from Waste Water as Magnesium Ammonium Phosphate (struvite). *Astrid Durrant, Imperial College London (for CEEP, 1997)*

Secondary Sewage Effluent P Removal Pilot Project (P adsorption onto calcareous material), New South Wales, Australia. *S Short, P Nichols, Forbes Rigby Engineers*

Animal Wastes as a potential source of Recoverable Phosphorus. *Phil Hobbs, Institute of Grassland and Environmental Research UK*

Prospects for the recovery of Phosphorus from Animal Manures : a review. *J Greaves, P Hobbs, D Chadwick and P Haygarth, Institute of Grassland and Environmental Research UK*

Phosphate Recovery from Animal Manure, the Possibilities, report commissioned by CEEP 1998. *Leo van Ruiten, Van Ruiten Adviesbureau, Holland*

Recovery of Phosphate: What can the industry handle. *Dees Lijmbach, Thermphos*

Available on request:

In order to make information available before the publication of the formal proceedings of the Conference, please e-mail if you wish to receive:

Phosphate Removal and Recovery Technologies Morse, Brett, Guy and Lester, Imperial College London (for CEEP 1997) :

- full study 142 pages.
- review and summary in "The Science of the Total Environment" 13 pages.
- summary in "Phosphorus and Potassium" 9 pages.

Phosphate Recovery: An Economic Assessment

by Nannette Woods/CH2M HILL

Liliana Maldonado/CH2M HILL

Glen T. Daigger/CH2M HILL

Introduction

An increasing demand for sustainable resources and environmental stewardship has prompted industry to explore alternatives to conventional phosphate removal technologies, including those aimed at phosphorus control. This trend has been observed in countries such as The Netherlands, Japan, Italy, and South Africa. As a result, research and development are ongoing in these and other countries to explore the feasibility, economics, and performance of phosphorus treatment technologies that provide for the recovery of phosphorus as phosphate in usable forms.

In North America, water quality based regulatory initiatives have been implemented to reduce phosphorus discharge to receiving waters. Two primary regulatory approaches have been used in both the municipal and industrial sectors to meet this goal: restrictions on the use of phosphorus based products (source control) and strict control of phosphorus discharges (effluent permit limits). Recovery methods have not been used in North America to any significant extent. Long-term trends indicate the potential for increased interest and use of beneficial reuse and recycle options in lieu of the traditional treatment and discharge approaches used thus far. However, phosphate recovery will have to compete economically with established methods of phosphate removal. This paper presents the economic boundary conditions where recovery becomes more attractive than the traditional treatment removal methods.

Objectives

In February 1997, the Chemical Manufacturers Association Phosphate CHEMSTAR Panel commissioned CH2M HILL to assess the viability of implementing phosphorus recovery technologies at municipal wastewater treatment facilities in North America. The study focused on evaluating the benefits and costs of potential integration of phosphorus recovery technologies with existing phosphorus removal systems. In April 1998, the Panel expanded the study to include an evaluation of the economic boundary conditions to determine at what point recovery systems become viable. The specific objectives of these studies were to (CH2M HILL, 1997):

- Review the status of phosphorus removal in the North American municipal wastewater treatment industry
- Survey the available alternative phosphorus recovery technologies through a literature review
- Evaluate the viability of implementing select phosphorus recovery technologies through a literature review
- Evaluate the economic boundary conditions where phosphorus recovery becomes economical

The focus of this technical paper is on the economic boundary condition evaluation. However, a brief overview of the other objectives is required for development of the model used for the economic boundary condition evaluation.

Status of Phosphorus Removal

In response to phosphorus reduction initiatives implemented in the U.S., two regulatory approaches have been successfully used to minimize phosphorus releases to the environment:

- Restrictions on the use of phosphorus-based products
- Stringent phosphorus removal requirements for municipal wastewater treatment facilities and other direct dischargers

As shown in Figure 1, phosphorus reduction programs have been implemented in the U.S. on a regional basis, primarily in response to local water quality issues. In general, where such programs have been implemented, bans have been placed on the use of certain phosphorus-based products, such as detergents. Review of data from existing municipal facilities indicated that influent phosphorus concentrations in municipal wastewaters are in the range of 2 to 9 milligrams per liter (mg/L), with a median concentration of 6 mg/L noted.

Figure 1 Regional Implementation of Phosphorus Reduction Programs

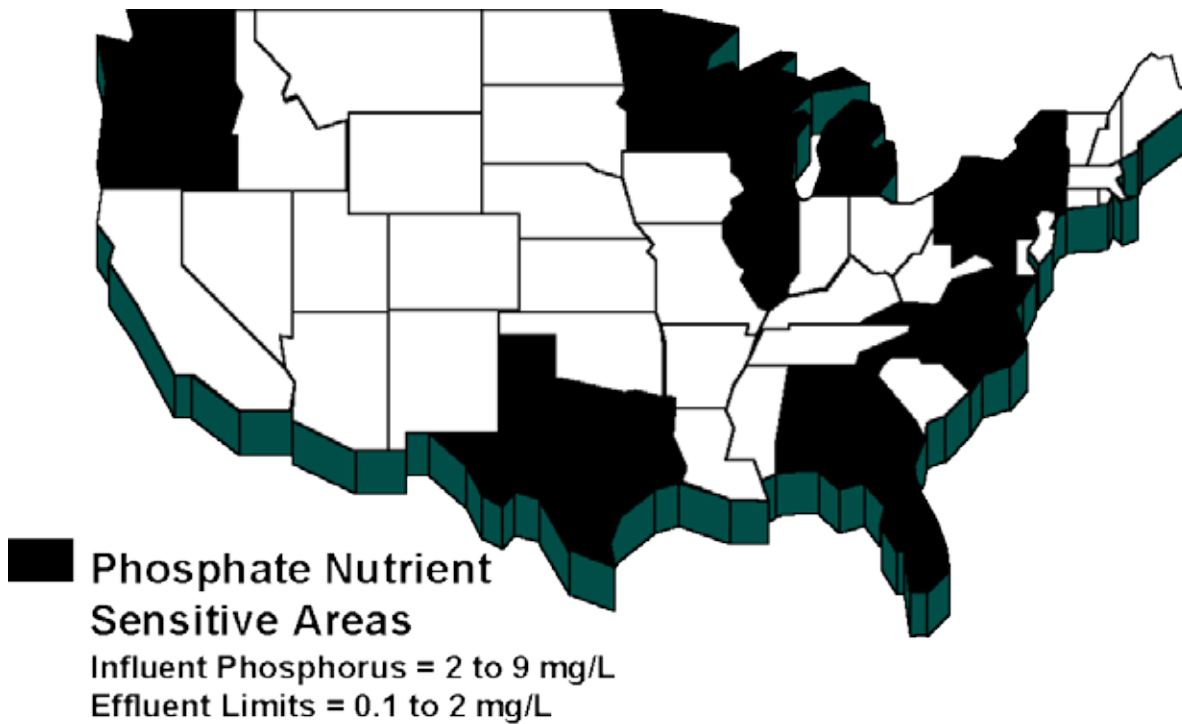

Current Phosphorus Removal Methods

Current methods typically applied at municipal wastewater treatment facilities to remove phosphorus include:

- Biological treatment: Phosphorus is incorporated into the biomass and removed via the biosludge. An anaerobic zone must be provided in the activated sludge basin to achieve enhanced removal of phosphorus to typical regulatory permit levels.
- Chemical treatment: Precipitating agents (typically, ferric chloride or other metal salts) are added at various points in the process train, whereby phosphorus is removed with the precipitate sludge.
- Combined biologicalchemical treatment: Often applied to meet more stringent criteria.
- Tertiary treatment: Lime addition and phosphorus precipitation are often used to meet very stringent limits.

Process flow diagrams for representative wastewater treatment scenarios that apply these methods are presented in Figure 2.

Figure 2

Representative Municipal Wastewater Treatment Scenarios

Biological Treatment

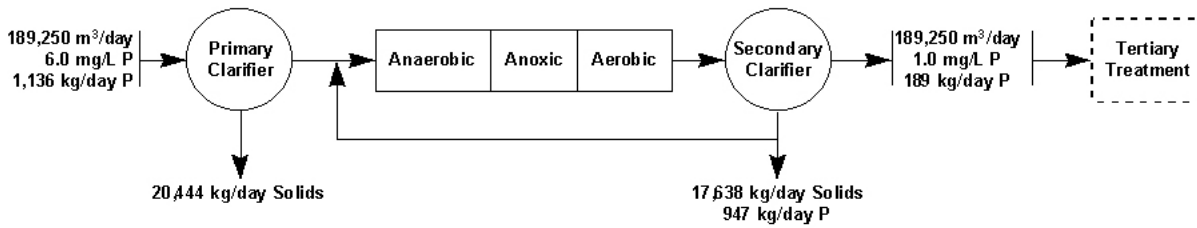

Chemical Treatment

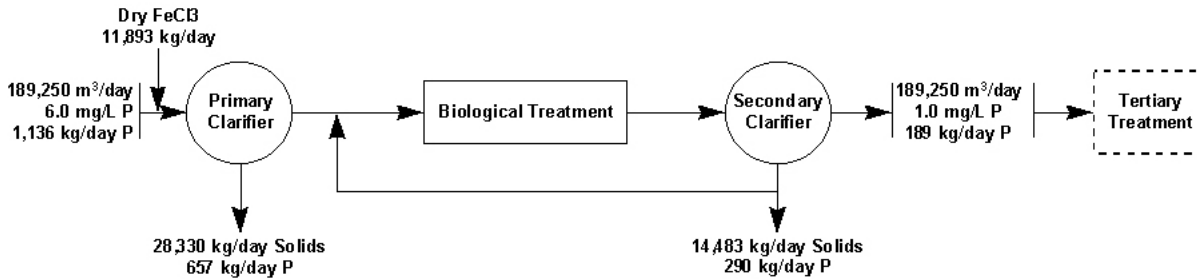

> br />

Potential Drivers for Implementing Phosphorus Recovery

The feasibility of implementing phosphorus recovery to compliment conventional methods currently employed at municipal wastewater treatment facilities was assessed using the following drivers:

- Potential for cost savings: chemical addition and sludge handling costs
- Potential for cost recovery: sale of recovered phosphate product
- Potential to enhance phosphorus removal: achieve lower effluent phosphorus concentrations

Global drivers for implementing phosphorus recovery might include the following:

- A demand for sustainable phosphorus resources
- Market/business product stewardship requirements and/or goals

Recovered and reused phosphorus products could potentially be used in lieu of phosphate ore as a raw material for many phosphorus-based products, including fertilizers. This would, in turn, provide a venue for improved stewardship of phosphorus-based products.

Selection of Representative Recovery Technologies

Review of the available literature resulted in the identification of 10 primary phosphorus recovery technologies. Six of these processes were selected for detailed literature review because they were considered to be representative of the major technologies identified in the literature. The detailed literature review addressed various criteria, including categorization of each process in terms of process chemistry, process application, and demonstration level. Using the demonstration level as a key indicator of the success of previous research and development efforts, the *Crystalactor*, *Phosnix*, and *Rim-Nut* processes were selected for detailed economic evaluation. These technologies were viewed as having the greatest potential to be implemented. Process flow diagrams for these technologies are presented in Figures 3 through 5.

Figure 3

Crystalactor Process Flow Diagram

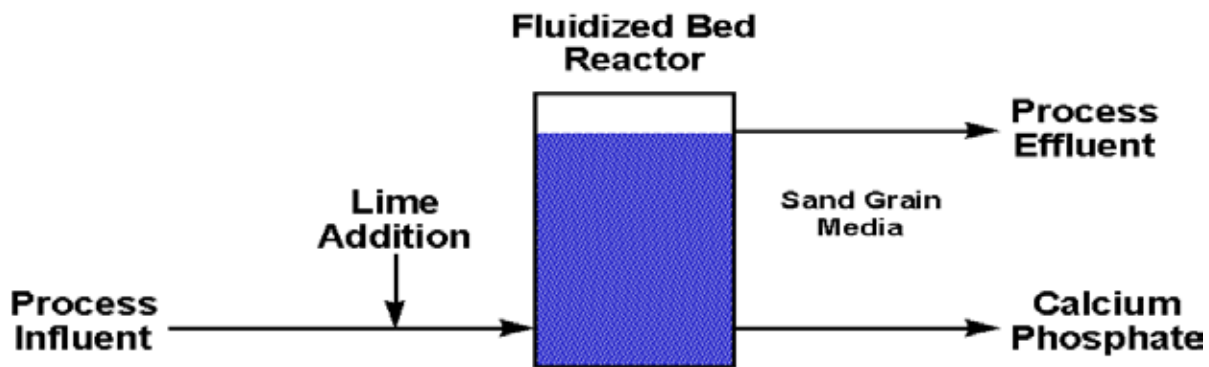

Figure 4

Phosnix Process Flow Diagram

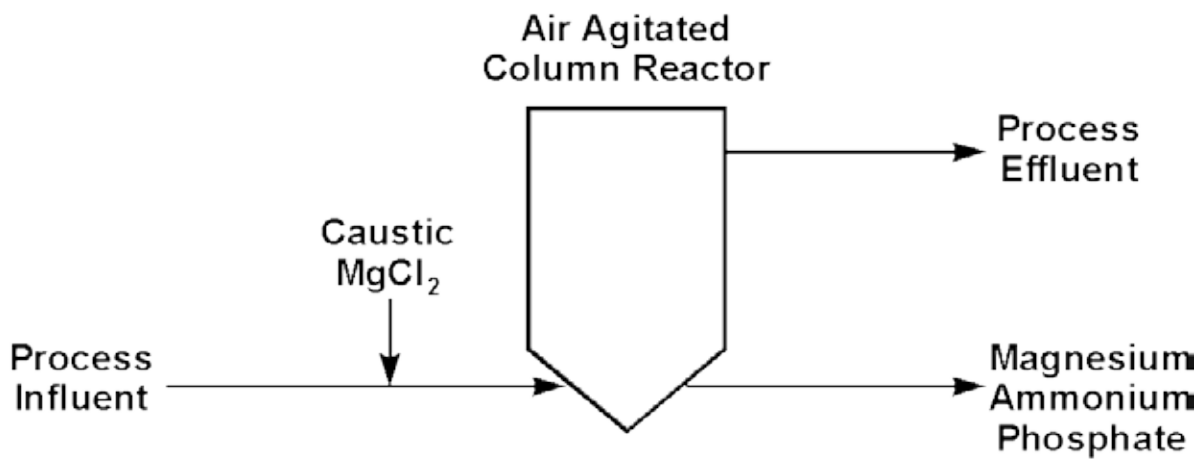
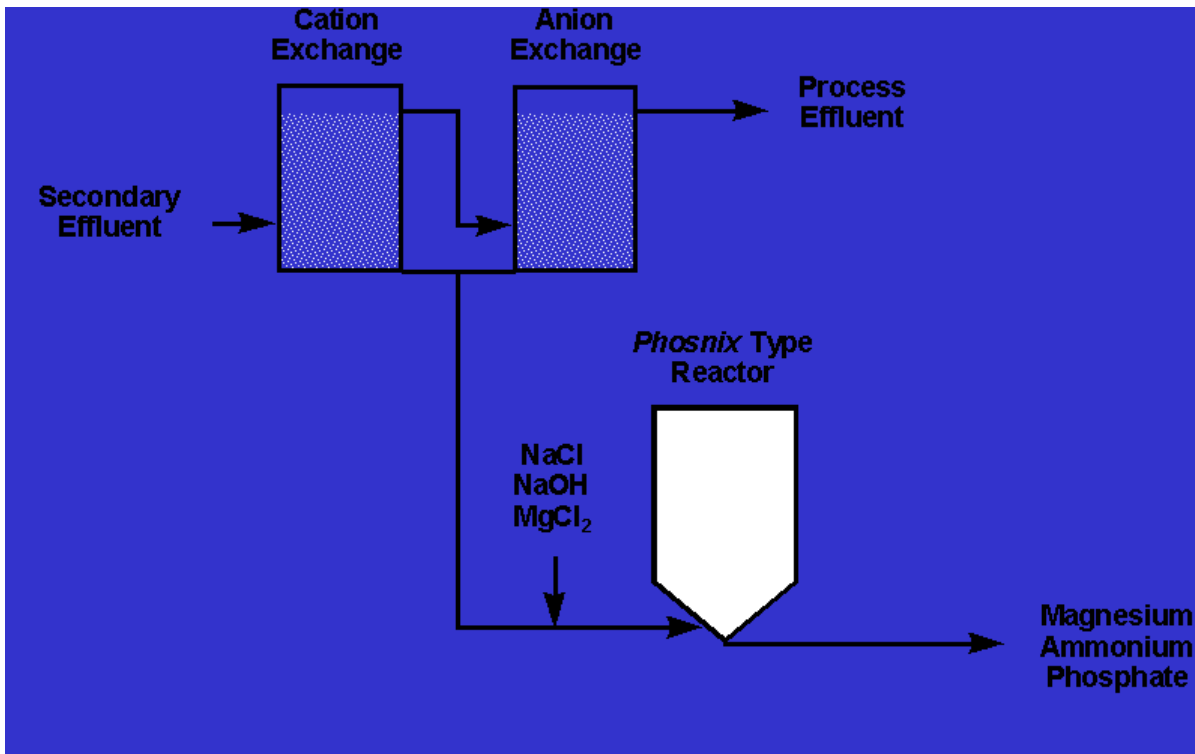

Figure 5

Rim-Nut Ion Exchange Process Flow Diagram



The *Crystalactor* process was selected for detailed evaluation as a representative method of calcium phosphate crystallization for both tertiary and sidestream treatment applications. As a tertiary treatment method, this process could potentially replace currently employed tertiary lime addition methods, offering the benefits of reduced lime usage and sludge generation. As a sidestream treatment method, the potential benefits of improving mainstream treatment performance and sludge quality were evaluated. For each application, the recovered calcium phosphate yield and value were assessed.

The *Rim-Nut* ion exchange process was selected for detailed evaluation as a representative method for recovering magnesium ammonium phosphate (MAP) via tertiary treatment. Full-scale implementation of this technology has been demonstrated, but the application focused on ammonia removal. For this study, the focus was on the phosphate recovery aspect. As a tertiary treatment method, its effluent characteristics, robustness, and reliability were assessed along with the recovered MAP yield and value.

The *Phosnix* process was selected for detailed evaluation as a representative method for recovering MAP in a sidestream treatment application. Full-scale implementation of the process has been demonstrated. As a sidestream treatment method, the potential benefits of improving mainstream treatment performance and sludge quality were evaluated, as well as the recovered MAP yield and value.

Economic Evaluation

Basis of Evaluation

Representative phosphorus recovery methods were evaluated using the following approach:

- Representative phosphate recovery technologies were integrated with representative municipal wastewater treatment scenarios (see Figure 6). These scenarios were developed using an EXCEL spreadsheet model.
- The value of recovered phosphorus, recovered as phosphate, was assessed assuming a similar value to that of phosphate ore (feed stock to phosphate fertilizer manufacturer).
- The impacts of phosphorus recovery on major operating costs were evaluated for a variety of variables to determine the economic boundary conditions at which the process becomes viable.
- The capital cost and associated payback period for implementing phosphorus recovery was determined.

Figure 6

Representative Municipal Wastewater Treatment Scenarios with Phosphorus Recovery

Biological Treatment, Sidestream Application

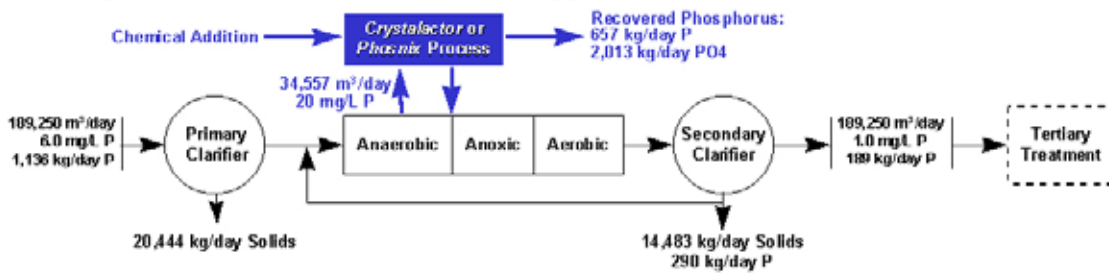

Chemical Treatment, Mainstream (Tertiary) Application

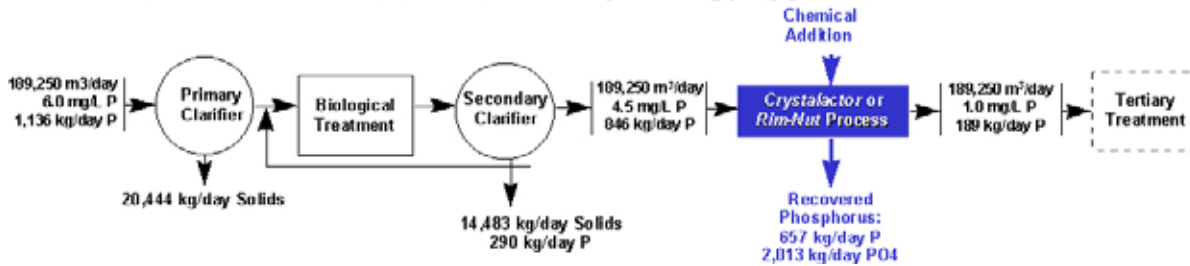

The best case approaches for implementing phosphorus recovery technologies at municipal wastewater treatment plants were evaluated as represented by the following scenarios:

- Biological treatment, sidestream application with *Crystalactor* process
- Biological treatment, sidestream application with *Phosnix* process
- Chemical treatment, mainstream (tertiary) application with *Crystalactor* process
- Chemical treatment, mainstream (tertiary) application with *Rim-Nut* ion exchange process

The model was evaluated for conventional biological and chemical treatment for comparison purposes.

The economic analyses were conducted using the following variables:

- Influent phosphorus = 6.0, 10, and 20 mg/L
- Sludge handling cost = \$22, 110, 385, and 825 per metric ton
- Chemical costs at low, mid-range, and high levels as shown in Table 1 (Chemical Prices, 1997)

Table 1

Chemical Cost Variables			
	Cost (\$/Metric Ton)		
Chemical	Low	Intermediate	High
Hydrated Lime	55	66	77
50% Sodium Hydroxide	220	275	330
Magnesium Chloride	220	275	330
Sodium Chloride	385	506	638
Phosphate Rock	25	27.5	30

The range of influent phosphorus concentrations used were higher than is currently observed in the United States. An influent phosphorus concentration of 6 mg/L was the mean concentration found in a recent survey of medium to large municipal wastewater treatment facilities in the United States (AMSA, 1995). The variables of 10 and 20 mg/L influent phosphorus were selected to provide a range of concentrations. A 10 mg/L phosphorus concentration is representative of a wastestream in a North American municipality, which has minimized inflow and infiltration. The higher value of 20 mg/L provides a "high-end" range for the model and bounds the concentrations that may be encountered in other countries.

The range of sludge handling costs covers the range of costs obtained in a survey of municipal wastewater treatment facilities in the United States (AMSA, 1995). The median cost from this survey is \$54 per metric ton.

The evaluations were conducted using an effluent phosphorus concentration of 1 mg/L and a flow rate of 50 mgd. An effluent phosphorus concentration of 1 mg/L is a typical permit standard in areas of the United States, where phosphorus limits are set. The flow rate of 189,250 m³/day is the median flow rate at medium to large municipal wastewater treatment facilities in the United States (AMSA, 1995).

The spreadsheet modeling process begins by completing a mass balance for each technology scenario. The mass balance calculations were developed primarily to quantify, on a relative basis, the factors that could influence the economic viability of phosphorus recovery technologies and are not intended to represent a rigorous analysis of the biochemistry of phosphorus removal.

The mass balance information was used to determine chemical requirements, sludge volume generated, and recovered phosphate volume generated. The costs associated with these materials and products were then determined. The sum of the chemical costs, sludge handling costs were subtracted from the recovered phosphate value to obtain the major operating costs associated with phosphorus recovery or removal. The major operating cost was subtracted from the major operating cost for conventional phosphorus removal (either biological or chemical) to obtain the net operating savings. The results of these calculations are provided in Tables A-1 through A-6 in the Attachment.

To put the cost savings discussed below in perspective, a typical 189,250 m³/day plant might spend from \$7 to \$9 million per year on operation. Of this total operating costs, sludge operations might range from \$0.3 to \$5.0 million per year.

Impact of Variables on Operations Cost Savings

Relative to the influent phosphorus concentration and sludge handling cost, chemical cost has minimal impact on the economic viability of the phosphorus recovery technologies. Figures 7 and 8 provide examples of the influence of chemical costs on the net operations savings for a biological treatment system with a sidestream *Crystallactor* system and a Chemical treatment system with a mainstream *Rim-Nut* system, respectively. The net savings only changed slightly, compared to the impact of sludge handling costs for the *Crystallactor* system. Only those technologies requiring large volumes of chemicals, such as the *Rim-Nut* process, were greatly affected by changes in chemical cost. It should be noted that the value of the recovered phosphate is very small relative to the chemical costs in all scenarios evaluated.

Figure 7

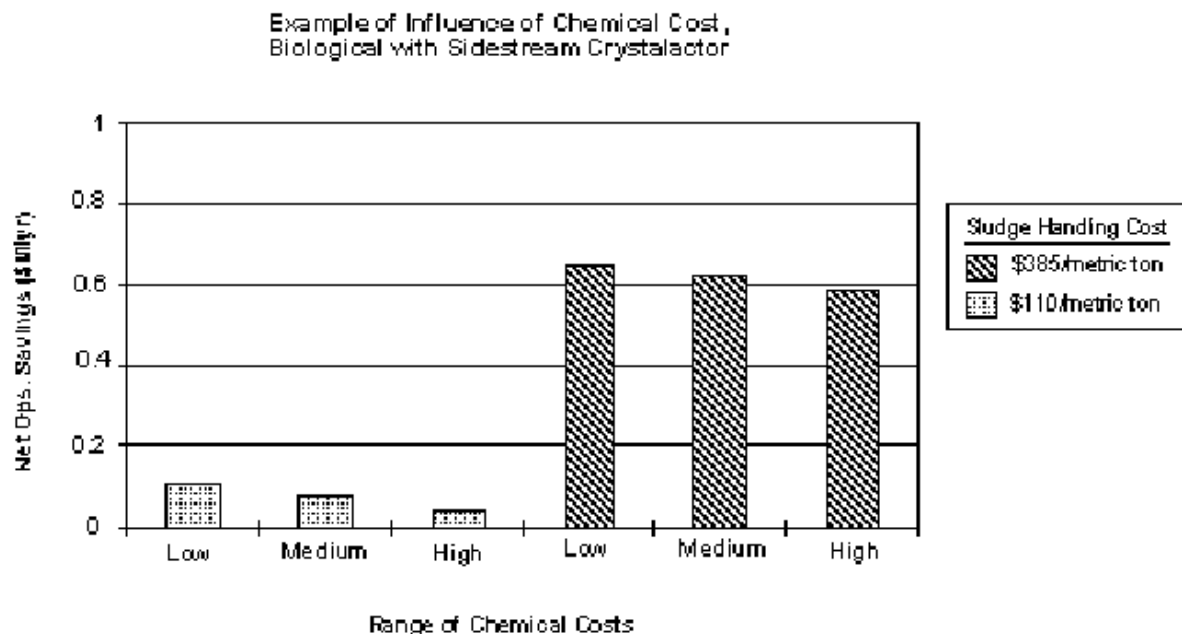

Figures 7 and 8 also illustrate the dramatic influence the sludge handling costs can have on the net operations savings calculated. For example, at high sludge handling costs, the *Rim-Nut* process results in overall savings, whereas at low sludge handling costs, the process results in increased operating costs.

Figure 8

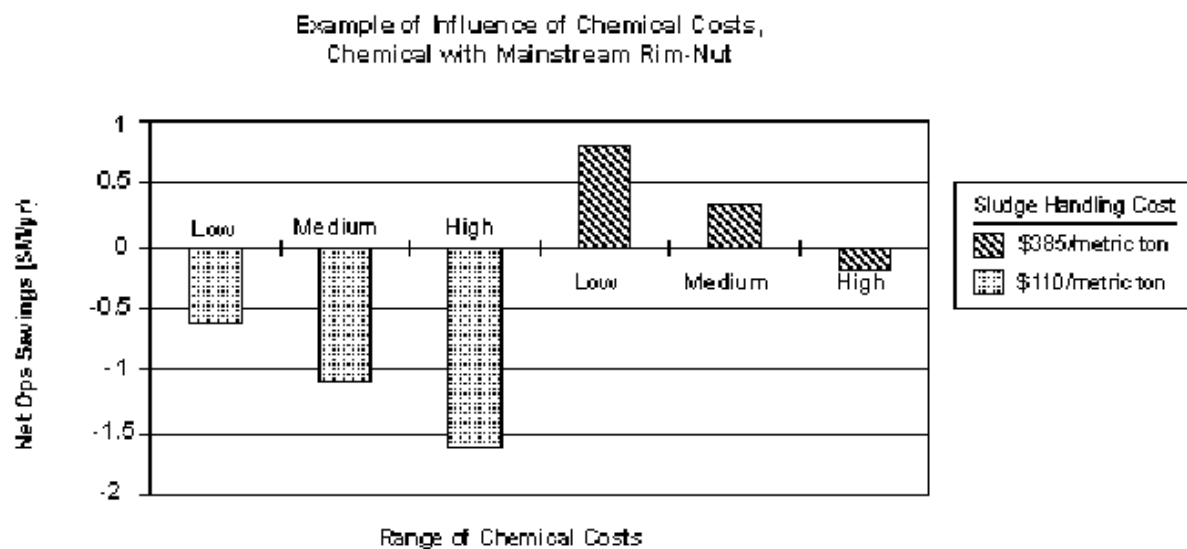

The influence of influent phosphorus concentration on net operations savings is illustrated in Figure 9. The impact on savings was most dramatic for the mainstream *Crystalactor* process. This is due to the high chemical cost for conventional chemical treatment at high influent phosphorus concentrations. The cost of the conventional chemicals is a direct function of the phosphorus concentration, whereas the chemicals for the *Crystalactor* process are independent of phosphorus concentration. The net cost actually increases (negative savings) with the phosphorus concentration for the *Rim-Nut* process. The chemicals required for this process are also a direct function of the phosphorus concentration. Although not shown, the same is true for the sidestream *Phosnix* process.

Figure 9

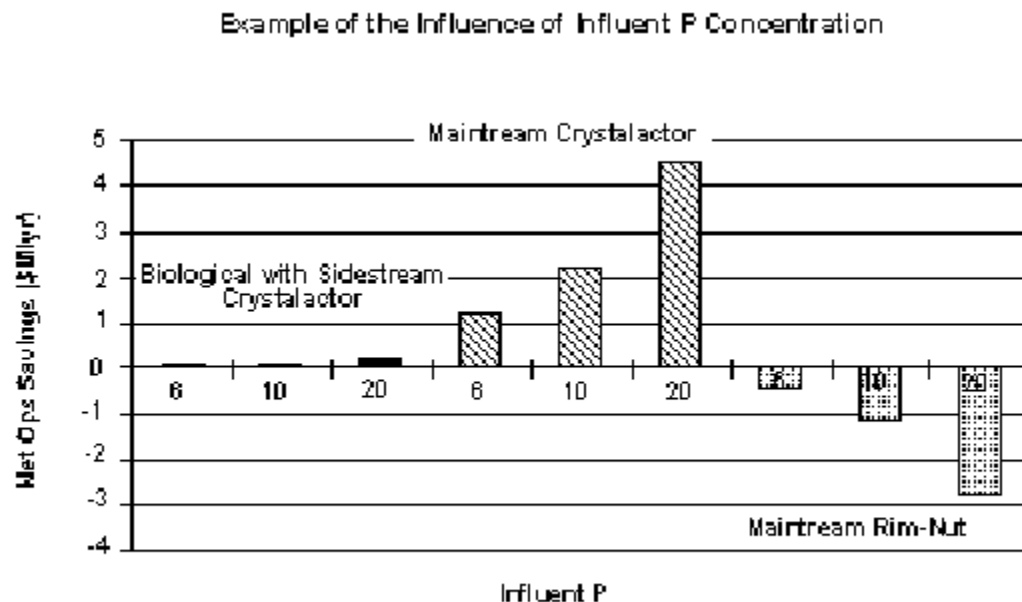

Comparison Between Technologies

A comparison of the major operating costs between the technologies is provided in Figure 10. The costs for conventional biological and chemical phosphorus removal are included for comparison. The costs associated with chemical additions for the *Phosnix* and *Rim-Nut* ion exchange processes are generally greater than the cost savings that can be realized from reductions in sludge generation and the sale of the recovered phosphate product. Therefore, the *Crystalactor* process should be considered the most economically attractive technology for phosphorus recovery when considering operating costs. The cost savings of the *Crystalactor* system is greatest when comparing the mainstream *Crystalactor* system to the conventional chemical system than for the side stream *Crystalactor* system compared to conventional biological treatment. There are no net operations savings in using the *Crystalactor* process when compared to the conventional biological system.

Figure 10

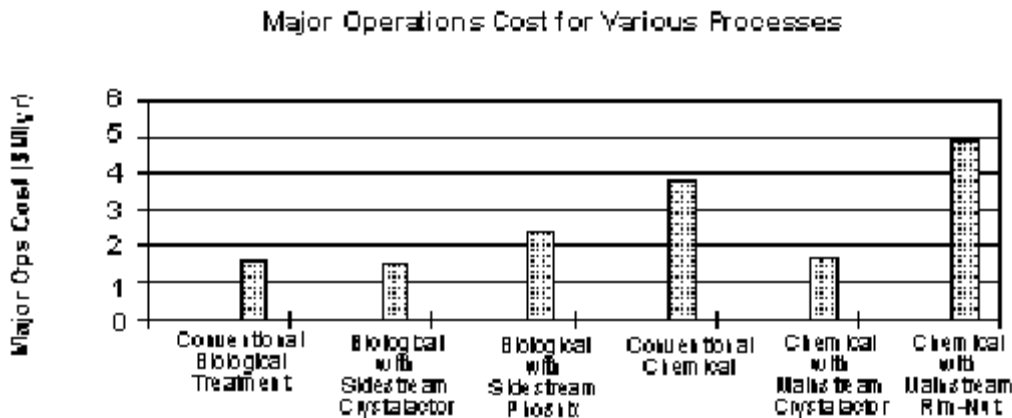

Payback Analysis

Capital cost estimates for implementing the *Crystalactor* process for phosphorus recovery are presented in Table 2. Cost estimates for the *Crystalactor* process equipment were provided by DHV Water BV (The Netherlands). The raw equipment costs appear in parentheses. Based on engineering experience with similar projects and professional judgment, costs for ancillary facilities, support equipment, and installation were estimated as a percentage of the equipment cost. These are order-of-magnitude costs expected to be accurate within a range to +50 to -30 percent.

Table 2

Capital Costs for the <i>Crystalactor</i> Process	
	Installed Cost (\$ million)
Sidestream application	\$15 to \$20 (\$10.9)*
Mainstream application	\$40 to \$45 (\$30.7)*

*Equipment costs, noted in parentheses, were provided by DHV Water BV, The Netherlands. Based on a total plant flow of 189,250 m³/day.

Table A-7 presents the *Crystalactor* process scenarios that provide an estimated payback period of less than 20 years. The payback period was estimated as the number of years required to recover the cost of installing the process given the potential net operating savings reported. This information is also illustrated in Figures 11 and 12 for the two *Crystalactor* processes. These figures suggest that the application of phosphorus recovery technologies becomes viable (payback period of less than 5 or 10 years) only at high influent phosphorus concentrations and/or high sludge disposal costs.

Figure 11

Payback Period Chemical with Sidestream *Crystalactor*

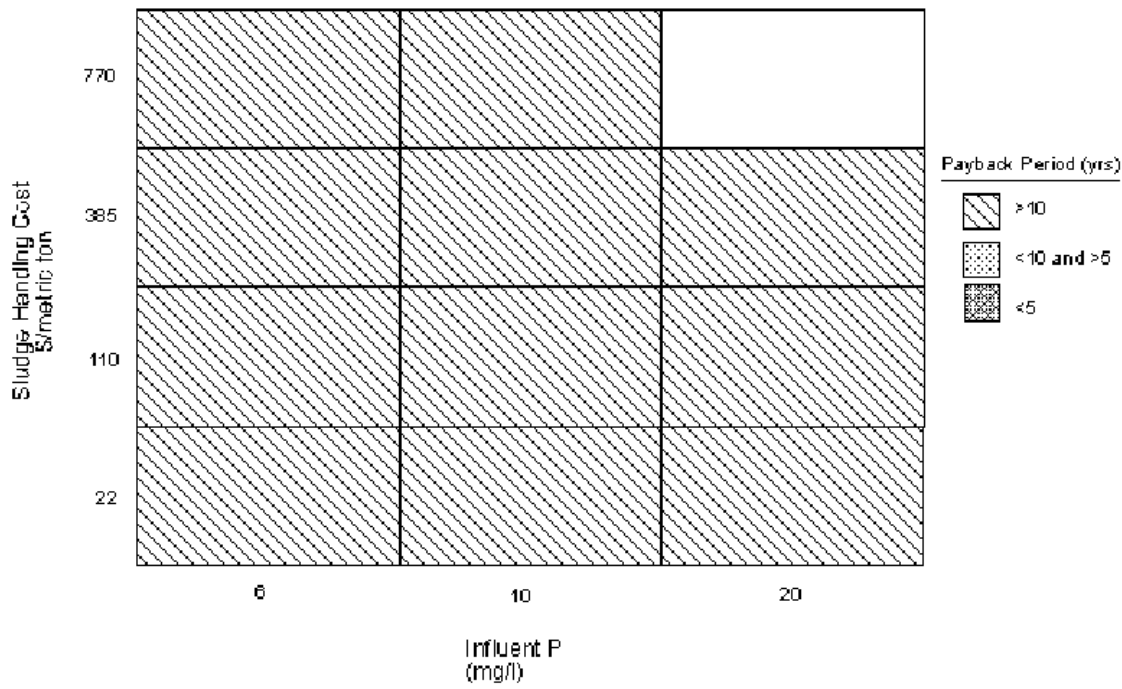

These findings are consistent with anecdotal information provided by DHV Water BV which indicated that, in their experience, the *Crystalactor* process has not been found to be cost-effective at influent phosphorus concentrations below 10 mg/L.

Besides economics, other drivers could positively impact the potential applicability of the technology in the future. These drivers might include legislation or regulations affecting sludge disposal options and/or costs; demands for sustainable resources; reuse or recycling initiatives; and changes in market conditions.

Figure 12

Payback Period Chemical with Mainstream *Crystalactor*

Conclusions

The following conclusions were reached as a result of this study:

- Of the available phosphorus recovery technologies, the *Crystalactor* process (or similar calcium phosphate recovery processes) offers the most likely potential in terms of operating cost savings. Relative to the *Crystalactor* process, other phosphorus recovery technologies are less attractive due to high chemical addition requirements.
- The economic incentives for implementing phosphorus recovery are minimal under current operating scenarios in the United States.
- The value of the recovered phosphorus product is insignificant relative to the cost of chemicals required for recovery and the capital cost of the facilities.
- Reductions in sludge handling costs do not provide for an attractive payback of the capital investment associated with implementing phosphorus recovery. Phosphorus recovery may be more cost-effective at locations where very high sludge handling costs are incurred.
- The economic boundary condition evaluation showed that phosphorus recovery becomes economically viable only at high influent concentrations and/or high sludge handling costs.

This study focused on cost-effectiveness as the key requirement for potential marketability of phosphorus recovery. Based on this requirement, phosphorus recovery does not appear to offer widespread applicability in North America at this time. Specific conditions may exist where cost-effectiveness may be possible. For example, if in a large urban area sludge disposal costs were to increase substantially (up to the \$770 per metric ton range) and water conservation was implemented (increasing the influent phosphorus concentration to greater than 10 mg/L), the payback period could fall to the 5- to 10-year range and thus be potentially viable for a municipality. In addition, phosphorus recovery from agricultural wastes, which may have low flows and high phosphorus concentrations, may be economically viable in some situations.

Broad-based incentives may also be necessary to increase the attractiveness and/or demand for implementing phosphorus recovery technologies. Such incentives may take the form of societal demands for sustainable resources and/or regulatory agency actions that impose recovery or reuse requirements on municipal and industrial wastewater treatment providers.

Acknowledgments

The authors would like to thank Shawn Sock and Tom Simpkin/CH2M HILL for assisting with this project and the Chemical Manufacturers CHEMSTAR Phosphate Forum of North America for their funding and technical assistance.

Albright & Wilson, Glen Allen, Virginia, USA

Albright & Wilson, Americas, Mississauga, Ontario, Canada

FMC Corporation, Princeton, New Jersey, USA

Rhodia a Rhône-Poulenc Company, Cranberry, New Jersey, USA

Solutia, Inc., St. Louis, Missouri, USA

For more information regarding the CHEMSTAR Phosphate Forum of North America contact Kathy Marshall at 703-741-5619 or via E-mail at kathy_marshall@mail.cmahq.com

Authors

Nanette Woods
CH2M HILL
Hillsboro Executive Center North
800 Fairway
Deerfield Beach, FL 33441-1831
e-mail: nwoods@ch2m.com

Liliana Maldonado
CH2M HILL
625 Herndon Parkway
Reston, VA 22090-1483
e-mail: lmaldonado@ch2m.com

Glen Daigger
CH2M HILL
100 Inverness Terrace East
Englewood, CO 80112-5304
e-mail: gdaigger@ch2m.com

References

Phosphorus Recovery Evaluation—Report of Findings. Prepared for Phosphate CHEMSTAR Panel (CMA Reference Number PHOS-1.0-RRR-CH2M). CH2M HILL. September 1994.

The AMSA Financial Survey. 1995.

"Chemical Prices." *Chemical Market Reporter*. Week ending February 14, 1997.

PERSPECTIVES FOR P RECOVERY OFFERED BY ENHANCED BIOLOGICAL P REMOVAL

Jonathan Strickland

Innovation Technologist, Anglian Water Services, Henderson House, Lancaster Way, Ermine Business Park, Huntingdon, Cambridgeshire, PE18 6XQ

ABSTRACT

The current position with respect to phosphorus removal in a UK water company is discussed. The factors that would favour a change from the current practice of metal salt dosing to Biological removal are examined. The potential for therefore recovering phosphorus fixed biologically is considered and possible process routes presented.

KEYWORDS

Phosphorus, Nutrients, Activated Sludge, Biological Phosphorus Removal, Struvite

INTRODUCTION

Anglian Water is geographically the largest of the 10 Water Companies of England and Wales and also has the largest requirement for P removal under the Urban Waste Water Treatment Directive. By the end of 1998 sewage works of one million population equivalent in Eastern England will be subject to phosphorus discharge standards, amounting to around 20% of the connected population.

The method used to achieve this phosphorus removal initially will be metal dosing usually with Ferrous (Fe II) salts. In 1999 the water industry England and Wales will enter its third five year regulatory period, and this is expected to include a further requirement for Phosphorus removal probably doubling the population served in Eastern England.

There is therefore now sufficient Phosphorus available for recovery at sewage works for this to be viable, but a number of obstacles exist before this potential can be realised.

CURRENT PRACTICES

A decision was made in the mid 1990s that the current requirement for phosphorus removal in Anglian Water would be met using metal salt dosing. This was based on a number of considerations.

1. Around half the works requiring phosphorus removal utilise trickling filters for either a part or all of the flow. Only metal salt dosing can be used to remove phosphorus in these cases.
2. Of the works using activated sludge as a part or the only treatment process, a significant number co settled waste activated sludge in the primary tanks. If biological phosphorus removal was applied in those cases, any Phosphorus accumulated biologically would be released in the primary tanks and recycled.
3. The works which had a significant portion of activated sludge and were suitable for conversion to biological phosphorus removal also utilised anaerobic sludge digestion. This was believed to cause the release of phosphorus into the liquor and following sludge thickening, recycling of phosphorus once again to the works inlet.

BIOLOGICAL PHOSPHORUS REMOVAL

Research on Biological Phosphorus removal in Anglian Water has indicated the following :-

1. Phosphorus can be successfully removed from wastewater using mainstream Bio P configurations.
2. In a minority of cases this removal can be maintained year round without any additional chemical dosing.
3. For most sites backup chemical dosing of some sort would be required during the winter months to maintain removal.
4. The process can be operated with the normal level of process control currently employed in Anglian Water.
5. Storage of waste activated sludge resulted in release of phosphorus to the liquor.
6. Anaerobic digestion of the resultant sludge compared to non Bio P sludge doubled liquor phosphorus concentrations, but also significantly increased concentrations in the solid phase. Most of the phosphorus was still associated with the sludge solids.

There remain therefore two problem areas which need to be overcome before Biological Phosphorus removal can be adopted widely. These are the need for a means of maintaining performance in winter months, and the need for a means of liquor treatment which breaks the loop of returned phosphorus from sludge thickening, digestion and dewatering back to the works inlet.

There are three ways in which winter performance can be maintained.

1. A sludge fermenter can be used to maintain volatile fatty acid concentrations, but these add VFAs in a relatively uncontrolled way, and are at odds with sewage works best practice of removing sludge from primary settlement tanks quickly and

minimising soluble BOD loads. They are a moderately expensive item of capital plant. There is some evidence that over dosing of VFAs encourages mousse formation, which tends to be a feature of biological phosphorus removal plants. If sludge fermenters are to be useful therefore, a means of controlling their output to that required for P release only needs to be developed.

2. Direct dosing of acetic acid can be used to maintain VFA concentrations, and this has the advantage of being controllable. However acetic acid is expensive and requires a high standard of storage and safety equipment.
3. Metal salt dosing can be used to maintain phosphorus removal but if this is done a method of control needs to be established such that dosing is matched to need, and chemical removal does not take over from biological removal.

There are numerous possible techniques for avoiding the return of phosphorus with sludge liquors.

1. If waste activated sludge is thickened quickly the phosphorus remains with the solid phase and the liquor has a quality similar to final effluent. If digestion follows and the resultant sludge is used as liquid to agricultural land no further treatment is necessary. A modest level of thickening would also be unlikely to cause problems.
2. If dewatering is carried out following digestion a liquor will be produced containing elevated levels of Phosphorus. This stream according to experimental work represents in mass terms about 15% of the Phosphorus load to the works. This could be economically treated by a number of chemicals, such as Iron or calcium.
3. The observation that little phosphorus is present in soluble form in the sludge liquor, implies precipitation within the digester. This is likely to be in the form of Struvite, which is observed in AW digesters. This is also undesirable as it can lead to pipework blockage. An alternative to this is to deliberately allow waste activated sludge to release Phosphorus prior to thickening and then take this liquor to a chemical removal stage.

POTENTIAL FOR PHOSPHORUS RECOVERY

Phosphorus recovery is only possible if biological phosphorus removal is carried out. This is because Iron phosphates are not suitable for processing in the phosphate industry, and also the processes used result in phosphorus being dispersed in the total sludge production. Phosphorus recovery therefore depends on the adoption of Biological Phosphorus removal. Iron salt dosing has at present been chosen because of the ease of installation and operation, however, a number of issues could result in this option becoming less attractive. The advantages and disadvantages of metal salt dosing are listed below.

Table 1 Advantages and disadvantages of Metal salt phosphorus removal

Advantages	Disadvantages
Ease of Installation	EA discouragement of chemical dosing
Inexpensive chemicals used	Sludge production increased
No liquor problems	Rising demand may increase chemical price
Reduced H ₂ S formation in digesters	Iron and other metals dispersed in the environment
No struvite precipitation	
Otherwise waste materials recycled to useful purpose	

It is therefore possible to list those factors which may encourage a move to biological phosphorus removal.

1. Regulatory requirements from the EA
2. Closure of agricultural disposal route for metal amended sludges
3. Closure of agricultural disposal route for all sludges and consequent increase in disposal cost/tonne.
4. Large increase in Phosphorus removal requirements causing greater demand for metal salts.

Other factors that would encourage biological phosphorus removal are increasing ease of operation of such plants, and a value being placed on recovered phosphorus.

The potential for phosphorus recovery therefore depends in the UK and in Anglian Water particularly on the number and size of plants which are required to remove phosphate, and are potentially available for conversion to biological removal, without requiring the continuous use of iron dosing on site (i.e. without any element of trickling filters).

The list of current sites , size and process type are listed below.

Table 2 AW works requiring P removal

Site	Process	Population Equivalent	Available for Biological conversion and P recovery
Original AMP II commitment			
Needham Market	Trickling Filters	11666	
Stowmarket	Trickling Filters	19886	
Stalham	Trickling Filters	10928	
Halstead	Activated Sludge	11410	11410
Louth	Trickling Filters	22948	
Brackley	Activated Sludge	20592	20592
Cotton Valley	Activated Sludge	244185	244185
Bedford	Combined AS and TF	196059	
Chalton	Combined AS and TF	64732	
Bocking	Trickling Filters	16767	
Braintree	Trickling Filters	21263	
Shenfield	Activated Sludge	46357	46357
Whilton	Trickling Filters	25513	
Oakham	Trickling Filters	11177	
Great Billing	Combined AS and TF	285959	285959
Broadholme	Combined AS and TF	209214	
Corby	Two stage Biofilm/AS	133310	
New commitments during AMP II			
Bury St Edmunds	Trickling Filters	76471	
Fakenham	Trickling Filters	18028	
Dereham	Trickling Filters	13355	
Totals	20	1459820	322544
			608503

Great Billing is included as a plant that could potentially be used for Phosphorus recovery as the Trickling filters treat a relatively small proportion of the flow and extra Activated sludge capacity could be provided economically.

Therefore, of the 1.5 million p.e. requiring Phosphorus removal, only 300000 p.e. is potentially available for recovery immediately, with a further 300000 available relatively easily.

POTENTIAL PROCESS LAYOUTS FOR PHOSPHORUS RECOVERY

In order to recover Phosphorus from sewage it is necessary to identify a point in the process train where suitable conditions are likely to exist for recovery to be economic. Three likely points usually exist. These are :-

1. The RAS return line. This is typically used in the Phostrip process where a proportion of RAS can be passed through a stripper tank, and the supernatant subjected to Lime precipitation.
1. The waste activated sludge line. Phosphorus can be released from this sludge and then chemically precipitated in much the same way as the Phostrip process.

1. The digester supernatant liquor line. Phosphorus released in the digesters can be precipitated from the liquors.

In order to select the most likely point for Phosphorus recovery, the advantages and disadvantages of each point need to be considered, and the possible yield of Phosphorus at each point considered. To assist with this an idealised sewage works treating 100000 p.e. is used. This works would have a phosphorus input of 300 kg/day. 20000 m³/day of sewage would be treated per day and the activated sludge plant would have a total volume of 13000m³. The RAS flow is assumed to be 20000m³/day.

This basic works is shown in figure 1. The influent Phosphorus load of 300 kg P is reduced to 20 kg in the effluent, equivalent to 1 mg/l. The remaining phosphorus is wasted at a rate of 280 kg/day.

Figure 1 P balance - Idealised Treatment works

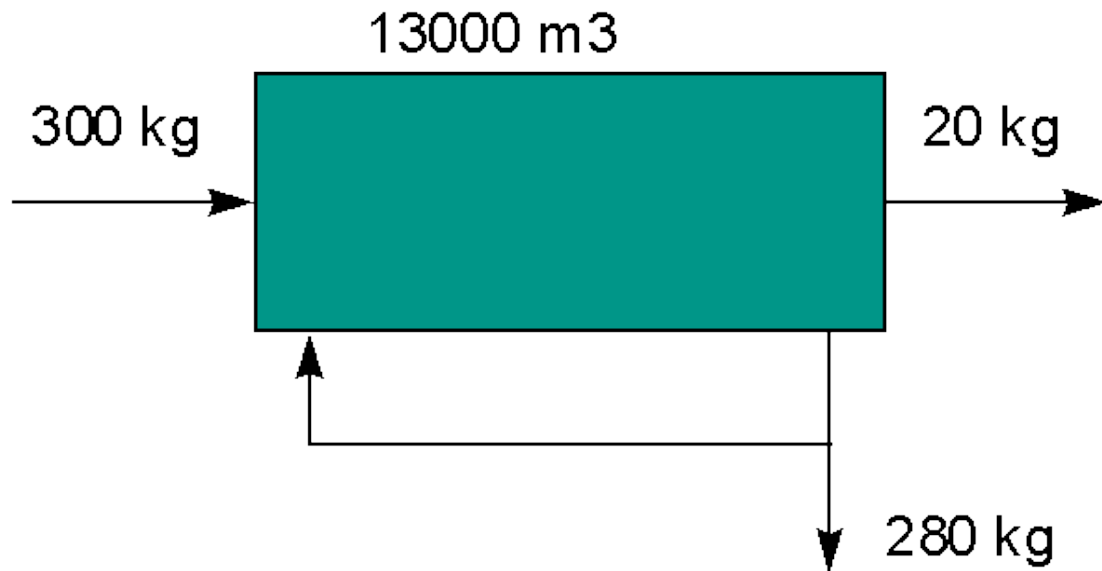

If the case of adding a Phostrip system (Figure 2) is considered a side stream stripper tank is assumed to be added to the RAS return line taking 10% of the return sludge and stripping it. Rather idealistically it is assumed to be capable of reducing P in the stripped sludge to zero. Since sludge is recycled at 20000 m³/day, 2000m³/day of RAS will pass through the stripper each day. At twice the mixed liquor concentration this is equivalent to 31% of the sludge in the plant each day. Taking into account the other sink for phosphorus in the plant, that is sludge wastage (10% of the sludge per day), a maximum of 212 kg/day is potentially available for recovery.

Figure 2 Idealised P balance - Phostrip plant

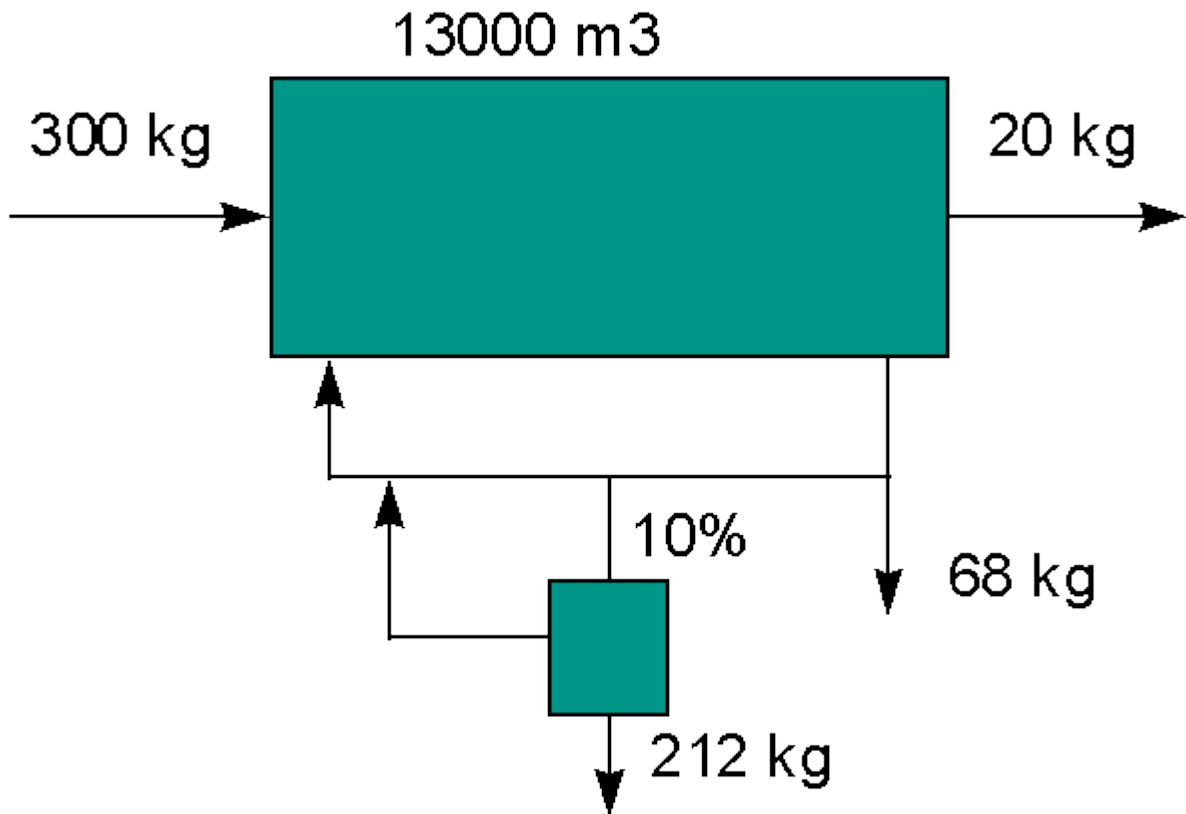

The layout and balance for treating sludge liquor is shown in Figure 3. The waste activated sludge is thickened quickly to retain the phosphorus in the sludge and this passes through digestion. Partition of phosphorus in the sludge between the liquor and the solid phase is subject to very varied estimates. Some reports have indicated that a high proportion of the phosphorus becomes available in the liquid phase, however experiments at Anglian Water using trial digesters, and BNR sludges, have indicated that although elevated, sludge liquor phosphorus amounts to only 15% of the phosphorus output. The remainder is in the solid phase. This appears to indicate that insoluble products such as struvite are being formed in the digestion process. Struvite is found on AW digestion plants, typically downstream of dewatering equipment probably due to aeration stripping carbon dioxide. However there appears to be only minor problems with struvite accumulation in digesters and the quantities of solid struvite found do not amount to the total possible weight. One possible explanation for this is that under the conditions in the digester, saturation for struvite formation is reached and as cells undergo lysis, the released phosphate precipitates quickly as a sort of cell cast. These would be small enough to act as colloidal solids, probably being incorporated with organic solids.

Therefore, depending on what happens within the digester, sludge liquor treatment could yield between 40 to 240 kg of recoverable P in the effluent. Under AW conditions the lower estimate would appear to be most likely to be achieved in practice.

Figure 3 Idealised P balance - Sludge Liquor plant

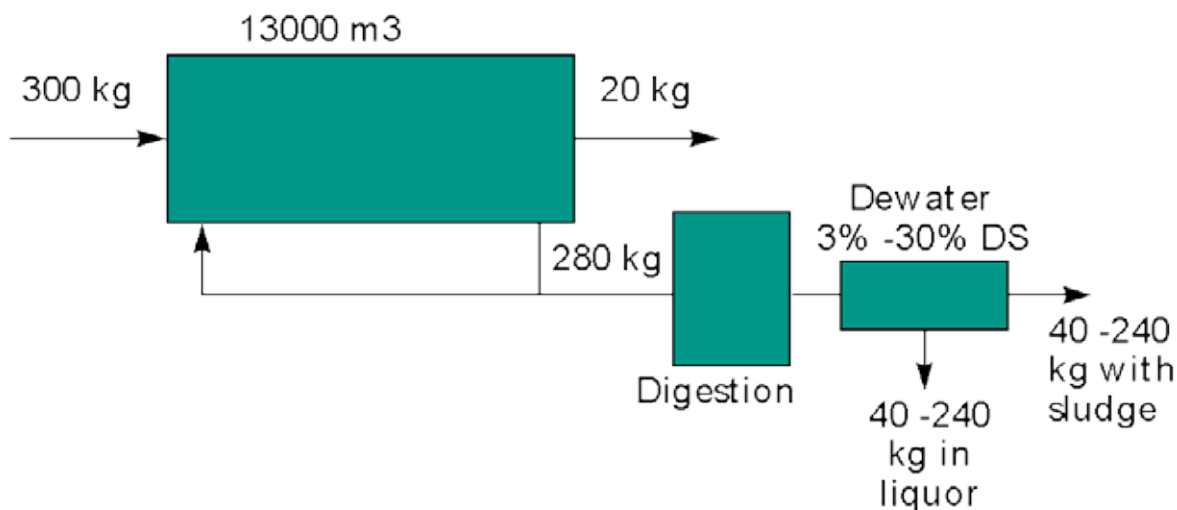

The third option is to take the waste activated sludge, cause this to release P and thicken this prior to digestion, or further processes. This is possible in either anaerobic (as in Phostrip) conditions, or extended aerobic conditions. The degree of release possible will depend on the length of time that the sludge is retained for in the release tank, but could be very high.

Figure 4 Idealised P balance - Waste activated sludge plant

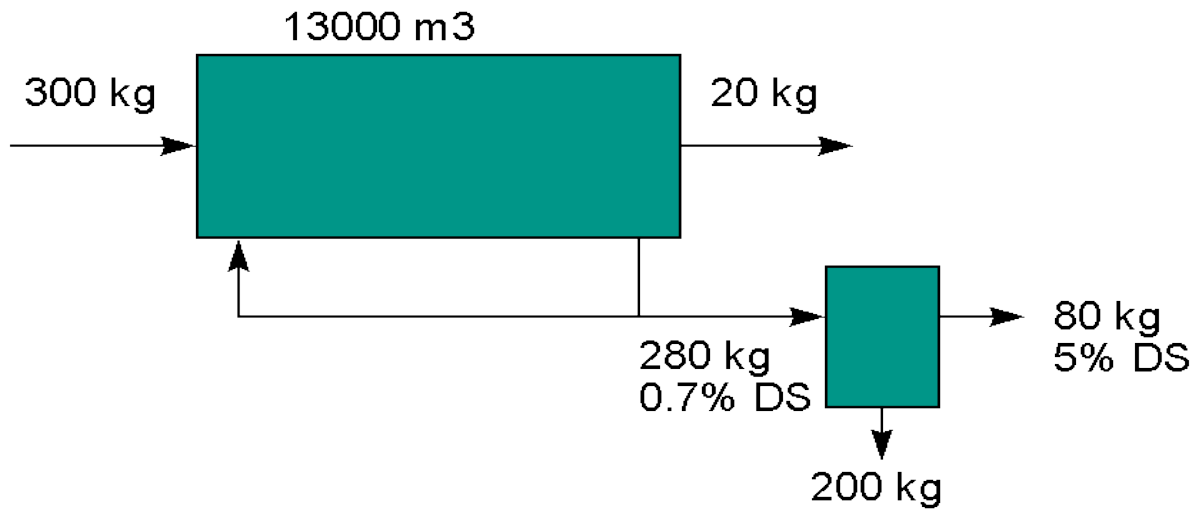

DISCUSSION

A number of obstacles exist to the implementation of P recovery on treatment works. These relate to the availability of suitable sites and the problem of operating a plant without a competitive process such as metal salt P removal locking up Phosphorus.

For a BNR plant concentrated streams of phosphorus liquor are available at three points. The digested liquor process would probably involve Struvite precipitation, and require a Magnesium feed to supplement high levels of Phosphorus and Ammonia normally present. For Anglian Water, this does not appear to be a good option as most of the phosphorus following digestion appears to be associated with the solid phase.

The two other options involve phosphorus recovery prior to digestion, and therefore in the relative absence of ammonia, so Calcium phosphate precipitation would be the preferred process. Both of these appear good options, but the WAS system is preferable purely for recovery. This is because assuming similar rates of P release are achieved in both cases, as this treats lower volumes of sludge daily, smaller tanks would be required, and existing dewatering equipment could be utilised for the liquor separation.

The Phostrip option would have other benefits in terms of stabilising the P removal process, by limiting phosphorus concentrations carried in the BNR sludge.

CONCLUSIONS

Practical possibilities for P recovery exist, but will depend for implementation on the economic value of the recovered material, and the need to achieve other objectives, such as widespread implementation of BNR, and possibly low phosphate sludges. All options require further investigation, and may be site specific. The process that becomes widely adopted will need to be simple, and require low manpower and maintenance.

ACKNOWLEDGEMENTS

The author acknowledges the permission of Anglian Water to present the paper. Any views expressed are those of the author, and not necessarily those of Anglian Water

ROLE OF BIOLOGICAL PROCESSES IN PHOSPHATE RECOVERY

Mark C.M. Van Loosdrecht
Kluyver Institute for Biotechnology
Delft University of Technology
Julianalaan 67
2628 BC Delft
Fax: 31-15-2782355
Mark.VanLoosdrecht@STM.TUdelft.nl

INTRODUCTION

Phosphate is the limiting component for growth in most ecosystems. Emission of phosphate in surface waters leads to eutrophication and blooming of algae. This has negative impacts on nature conservation, recreation, and drinking water production. Therefore it is essential to control the emission of phosphates from discharges of waste water. Governments have implemented regulation on phosphate emissions which in turn pushed the development of techniques for phosphate removal. With a stronger emphasis on a more sustainable society nowadays, also the recovery of phosphates from wastewater gets more attention.

Most wastewater is diluted and contains only low amounts of phosphorus (several milligrams) it is therefore not easy to recover phosphate in one step. Phosphate has concentrations of typically 10 mgP/l or below in most European wastewater. Effluent standards are typically in the range of 0.5-1 mgP/l, i.e. removal efficiencies of over 90 % have to be achieved. Chemical processes have as disadvantage that they are not selective. Since wastewater contains many different ions, these will always disturb the processes for chemical P-recovery. The lower the concentration needed to achieve (or the higher the percentage recovery) the more side-processes will occur. This either leads to a product with a high amount of contaminants or a train of pre-treatment techniques. Biological processes can be highly selective, and can achieve easily low concentrations. Disadvantage is that the phosphate is only concentrated in the biomass. If the phosphate is set free from the biomass in a small volume a concentrated phosphorus solution is obtained where physical-chemical techniques can be used for recovery. A combination of a biological process for concentrating the phosphates and a physical-chemical process for recovery seems therefore to be the best option for phosphorus recovery.

In this contribution an overview of the state of art of biological P-removal is given. This process is discussed in the context of recovery of phosphates from wastewater and an optimal "sustainable" wastewater treatment process.

BIOLOGICAL P-REMOVAL

Introduction

The first indication of biological phosphate removal occurring in a wastewater treatment process was described by Srinath et al. (1959) from India. The effluent of a treatment plant was used as fertiliser in rice paddys. At a certain moment the rice wouldnt grow due to a deficiency in phosphate. Shrinath et al. observed that sludge from this treatment plant exhibited excessive (more than needed for cell growth) phosphate uptake when aerated. It was shown that the phosphate uptake was a biological process (inhibition by toxic substances, oxygen requirement), and could be prevented when the initial stage of the plug flow process was properly aerated. Later, in more (plug flow) wastewater treatment plants this so-called enhanced phosphate removal was noticed.

Based on work by different groups biological Phosphate removal has become a full grown technology which can be applied on large scale. At this moment however, still no pure culture representative for the biological P-removal process has been isolated (Van Loosdrecht et al. 1997). This leads to much confusion because papers can have conflicting information. One of these is the term "luxury uptake" or "overplus effect" in the context of biological P-removal. These terms are used for the P-uptake exhibited by many (if not almost all) micro-organisms. When micor-organisms are after an anaerobic period, or a period without phosphate present, subject to an aerobic period with phosphate in the medium usually polyphosphate is accumulated. In these cases the P-uptake is a kind of transient response and not part of the normal metabolism. The polyphosphate accumulated by these organisms is only used as phosphorus reserve. The organisms involved in biological P-removal, however, accumulate polyphosphate as part of their normal physiology, and moreover can use the stored polyphosphate as energy storage (Van Groenestijn et al. 1989).

The physiology of the organisms involved had to be fully inferred from measurements on enhanced cultures. In these laboratory cultures bacteria are cultivated in such a manner that the bio-P organisms are favoured. This done in a cyclically operated batch reactor (SBR proces) where acetate from the influent is accumulated by the sludge in absence of oxygen or nitrate, after which oxygen or nitrate is dosed to the system allowing for cell growth and phosphate uptake. It is assumed that no other organisms then the bio-P organisms can grow in this system, since they only can derive energy from polyphosphate needed in the uptake of acetate. The physiological processes are further derived from these cultures by measuring conversion of all kind of compounds and by techniques such as in-vivo NMR.

Physiology

The physiology is described in several reference papers such as by Arun et al. 1987, Comeau et al. 1986, Kuba et al. 1993, Maurer et al. 1997, Mino et al. 1997, Pereira et al. 1996, Smolders et al. 1994 a,b. The physiology is typically divided in two phases: (I) an anaerobic phase in which substrate (fatty acids) are accumulated and stored inside the cells, the energy for this process is derived from polyphosphate and (II) an aerobic phase where the internally stored substrate is used for growth and phosphate uptake.

Under anaerobic conditions the bacteria use stored poly-phosphate as energy source for ATP production with the aid of the enzyme Poly-P:AMP-phosphotransferase (Van Groenestijn et al. 1987). ATP is used for the uptake of volatile fatty acids (VFA) and subsequent formation of polyhydroxyalkanoates (PHA). The reduction equivalents needed for the reduction VFA to PHA is derived from the conversion of glycogen to PHA (Arun et al. 1987, Smolders et al. 1994a). Since the transport energy for VFA and phosphate over the cell membrane is strongly influenced by the pH, the pH has a strong effect on the ratio between VFA uptake and phosphate release (Smolders et al. 1994a).

When oxygen, nitrate or nitrite are present in the absence of substrate, PHA is used as substrate. Under these conditions the bacteria not only produce new biomass but also restore the storage pools of polyphosphate and glycogen. This leads to a net uptake of phosphate in the overall process. If substrate as well as electron acceptors are present the substrate is predominantly converted into PHA instead of being used for growth (Kuba et al. 1994, Brdjanovic et al 1997).

The presence of three storage polymers in the cells (PHA, Glycogen and polyphosphate) makes the microbiology of the bio-P organisms extremely complex. A further complicating factor is that the growth of the cells is not directly coupled to substrate oxidation, as in normal microbiological processes. Growth results from the difference between PHA consumption rate and PHA use for glycogen and polyphosphate formation (Murnleitner et al. 1997).

Ecology

For normal bacteria their presence or absence in a treatment process is directly coupled to the sludge age of the process. For bio-P organisms this is not the case. The substrate they prefer - volatile fatty acids - can be used by hundreds of other normal heterotrophic bacteria which will under normal conditions do this more rapid and efficient than the phosphate accumulating bacteria. If one desires to accumulate the bio-P organisms for removal of phosphate from the waste water it is therefore needed to give them a selective advantage by properly using their unique metabolism. The possession of polyphosphate as energy reserve makes that in the absence of oxygen or nitrate the bio-P bacteria can accumulate substrates such as VFA inside their cells. By introducing an anaerobic period at the first stage of a treatment process in which sludge (bacteria) and wastewater are mixed fermentative bacteria will convert the organic carbon compounds into VFA. These can then be taken up by the bio-P organisms and stored inside their cells. If after this process has been complete the sludge is supplied with nitrate or oxygen the bio-P organisms have substrate inside their cells, whereas other bacteria do not access to this substrate and cannot grow. The bio-P organisms can grow and become in this way the dominant bacterium in the treatment process.

Process design

Any process for biological P-removal will also have to remove Nitrogen compounds. The latter is performed by an ammonium oxidation followed by a nitrate reduction process (nitrification-denitrification). Therefore a wastewater treatment process consists generally of three stages through which the sludge flows:

- Anaerobic compartment: needed for the selection of bio-P bacteria. It is crucial that no oxygen or nitrate is introduced in this compartment. The retention time in this compartment will generally depend on the rate of fermentation of the complex organic carbon to VFA.
- Anoxic compartment: needed for denitrification and P-uptake. It is advantageous to remove phosphorus by organisms that also denitrify. This will save significant amounts of organic carbon (Kuba et al. 1993,1996,1997, Sorm 1996). Accumulation of these kind of denitrifying bio-P organisms can best be achieved in UCT-like process configurations, in which sludge is continuously recycled between the anaerobic and the anoxic stage. The retention time in the anoxic reactor is determined by the denitrification rate or the hydrolysis rate by which particulate organic matter is converted into soluble substrate available for denitrification.
- Aerobic compartment: needed for nitrification and P-uptake. The aerobic compartment is mainly needed for the conversion of ammonium to nitrate. The formed nitrate is then recycled with the sludge to the anoxic compartment. The retention time in the aerobic compartment is determined by the nitrification rate.

From above description it becomes clear that the phosphate removal process is usually not determining the size of the treatment process. This makes that a biological P-removal process can be easily introduced in an existing treatment process. The main criterion for obtaining a good removal efficiency is the amount of bio-P bacteria formed. These are needed to accumulate the phosphate. The cells can maximal contain approx. 12% P on dry weight basis. This means that in the influent there needs to be enough organic carbon relative to phosphorus. As a rule of thumb approx. 20 gCOD is needed per gP which need to be removed as poly-P (remember that approx. 30 % of the P removed already by normal cell growth). In order to optimise the process it is needed to really ensure anaerobic conditions in the anaerobic zone. In a correct process configuration this is relatively easy to obtain by a control scheme based on redox electrode measurements (Van Loosdrecht et al. 1997, 1998).

Upgrading

Biological P-removal has to be implemented often in already existing process configurations. Sometimes this is directly possible in the existing reactor volume. However often the anaerobic compartment has to be added as an extension. Upgrading the treatment plant for bio-P removal needs to be done cost effective and with a stable process, including a stable sludge volume index. Taking this

into account an upgrading strategy has been developed and a specialised reactor has been designed which can easily be integrated in an existing treatment plant (Van Loosdrecht et al. 1998).

INTEGRATION OF CHEMICAL P-RECOVERY AND BIOLOGICAL PROCESSES

Regularly there is not enough COD present in the waste water to ensure a stable biological P-removal. In this case the biological process can be supported by a chemical precipitation. Hereto it is essential that the chemical precipitant does not accumulate in the activated sludge. This will lead to a lower sludge age and consequently higher sludge production and lower nitrogen removal efficiencies. Therefore a range of different processes have been developed in which the P is precipitated in a separate tank or reactor. The most applied variant is the pho-strip process. In this process all or a fraction of the return sludge is brought to an anaerobic tank where eventually some acetic acid is added. The sludge will release phosphorus which can then be precipitated. The precipitation can be done after sludge/water separation. In this case the phosphate can be recovered by e.g. crystallisation (Eggers et al. 1991). Since P can be precipitated at a higher concentration the required amount of chemicals is minimised. An elegant other alternative is retrieving P-rich supernatant at the end of the anaerobic phase and add recover the P from this flow (van Loosdrecht et al. 1998). This alternative doesn't require an extra reactor, and there is no need for acetate addition.

It could be realised that when bio-P organisms are only used to concentrate the phosphate much less bio-P bacteria are needed, i.e. less COD is needed. This is particularly of interest if there is a need for COD addition. It can be calculated that a normal bio-P process requires approx. 20 mgCOD/mgP removed compared to 2 mgCOD/mgP when all the P is eventually precipitated by a pho-strip like process (Smolders et al. 1996).

CONCLUDING REMARKS

Biological phosphorus removal is a grown up technology which can be applied. The only disadvantage might be its complexity, skilled people are needed for the design and supervision of such treatment plants. Biological can be used as a concentration step for the phosphate in diluted waste water. In a separate tank the phosphate can be released from the sludge after which the concentrated phosphate can be subjected to e.g. a crystallisation process.

Alternative process options for P-recovery can however also be evaluated. Burning and Gasification of biological materials is becoming more and more popular. If the P is accumulated in the sludge it will after these processes be accumulated in the ashes. It is worthwhile to evaluate whether the phosphorus can be recovered from these ashes.

A completely different alternative can be found when one realises that 80 % of the phosphate in the waste water originates from urine where the P is present in a high concentration. If an innovative collecting technique can be developed it would become relatively easy not only to recover phosphorus but also ammonium and other minerals.

REFERENCES

- Arun V, Mino T, Matsuo T (1987) Biological mechanisms of acetate uptake mediated by carbohydrate consumption in excess phosphate removal systems. *Wat. Res.* 22:565-570.
- Comeau Y, Hall KJ, Hancock REW, Oldham WK, (1986) Biochemical model for enhanced biological phosphorus removal. *Wat.Res.* 20:1511-1521.
- Eggers E, Dirkzwager AH, Van den Honing H (1991) Full scale phosphate crystallisation in a crystalactor. *Wat. Sci. Tech.* 24:333-334
- Kuba T, Smolders GJF, Van Loosdrecht MCM, Heijnen JJ (1993) Biological phosphorus removal from wastewater by anaerobic-anoxic sequencing batch reactor. *Wat. Sci. Tech.* 27:241-252.
- Kuba T, Van Loosdrecht MCM, Heijnen JJ (1996) Phosphorus and nitrogen removal with minimal COD requirement by integration of denitrifying dephosphatation and nitrification in a two-sludge system. *Wat. Res.* 30:1702-1710.
- Kuba T, Van Loosdrecht MCM, Brandse F, Heijnen JJ (1997) Occurrence of denitrifying phosphorus removing bacteria in modified UCT-type wastewater treatment plants. *Wat. Res.* 31:777-787.

- Maurer M, Gujer W, Hany R, Bachmann S (1997) Intracellular carbon flow in phosphorus accumulating organisms in activated sludge systems. *Wat. Res.* 31:907-917.
- Mino T, Van Loosdrecht MCM, Heijnen JJ (1997) Microbiology and biochemistry of the enhanced biological phosphate removal process. *Wat. Res.* Accepted.
- Perreira H, Lemos PC, Reis MA, Crespo JPSG, Carrondo MJT, Santos H (1996) Model for carbon metabolism in biological phosphorus removal processes based on in-vivo ¹³C-NMR labeling experiments. *Wat. Res.* 30:2128-2138.
- Smolders GJF, Van der Meij J, Van Loosdrecht MCM, Heijnen JJ (1994a) Model of the anaerobic metabolism of the biological phosphorus removal process; stoichiometry and pH influence. *Biotechn. Bioeng.* 43:461-470.
- Smolders GJF, Van Loosdrecht MCM, Heijnen JJ (1994b) A metabolic model for the biological phosphorus removal process. *Wat.Sci.Techn.* 31:79-93.
- Smolders GJF, Van Loosdrecht MCM, Heijnen JJ (1996) Steady state analysis to evaluate the phosphate removal capacity and acetate requirement of biological phosphorus removing mainstream and sidestream process configurations. *Wat. Res.* 30:2748-2760.
- Sorm R, Bortone G, Saltarelli R, Jenicek P, Wanner J, Tilche A (1996) Phosphate uptake under anoxic conditions and fixed film nitrification in nutrient removal activated sludge system. *Wat. Res.* 30:1573-1585.
- Srinath EG, Sastry CA, Pillai SC (1959) Rapid removal of phosphorus from sewage by activated sludge. *Experienta* XV:339-340.
- Van Groenestijn JW, Bentvelsen MMA, Deinema MH, Zehnder AJB (1989) Polyphosphate degrading enzymes in *Acinetobacter* spp. and activated sludge. *Appl. Environm. Microbiol.* 55:219-223.
- Van Loosdrecht MCM, Smolders GJF, Kuba T, Heijnen JJ (1997b) Metabolism of microorganisms responsible for biological phosphorus removal from wastewater. *Ant. v. Leeuwenhoek* 71:109-116.
- Van Loosdrecht MCM, Kuba T, Van Veldhuizen HM, Brandse FA, Heijnen JJ (1997c) Environmental impacts of nutrient removal processes: case study. *J. Env.Eng.* 123:33-40.
- Van Loosdrecht MCM, Brandse FA, De Vries AC (1998) Upgrading of wastewater treatment processes for integrated nutrient removal - the BCFS process *Wat. Sci. Technol.* Submitted.

THE PHYSICO-CHEMICAL CONDITIONS FOR THE PRECIPITATION OF PHOSPHATE WITH CALCIUM

WILLIAM A. HOUSE

Institute of Freshwater Ecology, River Laboratory, East Stoke, Wareham, Dorset, BH20 6BB, England, UK.
E-mail: w.house@ife.ac.uk

ABSTRACT

The most important factors controlling the chemical speciation of calcium and inorganic phosphate in fresh waters and waste waters are discussed. Solubility diagrams are used to illustrate the range of compositions that are predicted to be stable with respect to the formation of key calcium phosphate minerals and calcite. These include calcium hydroxyapatite, octacalcium phosphate, tricalcium phosphate and dicalcium phosphate dihydrate. The coprecipitation of phosphate with calcite is also considered.

The solution speciation, calculated from information on the formation of calcium phosphate ion-pairs at a given temperature, enables ion activities to be determined and the ion-activity product for the appropriate mineral to be compared with the thermodynamic solubility product. Examples of such calculations are presented for different types of water and some conclusions are drawn concerning future research developments.

Keywords: Calcium phosphate precipitation, calcite, phosphorus, phosphate.

INTRODUCTION

Chemical and biochemical precipitation of calcium carbonate/phosphate minerals is common in natural systems [1,2,3], although the elucidation of the mechanisms of formation, initiation of growth and transformations between crystal forms of the minerals, remains a major challenge. For carbonates, the most common mineral is calcite with reported occurrences of other polymorphs such as vaterite, aragonite and the mono and hexahydrates [4,5,6]. When calcite forms in solutions containing dissolved phosphate as ortho- or hydrogen phosphate, phosphate ions are incorporated in the lattice through surface adsorption and incorporation at "kink" sites [7]. The surface density of coprecipitated phosphorus has been found to depend on the adsorption isotherm, i.e. temperature, ionic strength and pH of the solution. Such coprecipitation occurs in many hardwater lakes [8], in algal biofilms that are associated with river-bed sediments [9] and is a self-cleaning mechanism in natural systems [10].

In contrast to this, calcium phosphate minerals are not often found in fresh- and waste water. The thermodynamically most stable form, at normal temperatures and pressure, is calcium hydroxyapatite (referred to here as HAP) but this does not form readily in spite of the occurrence of very high supersaturations. Other mineral phases such dicalcium phosphate dihydrate (DCPD), octacalcium phosphate (OCP) and amorphous tricalcium phosphate (TCP) form as precursor phases that transform to HAP [11].

FACTORS CONTROLLING THE PRECIPITATION KINETICS

These may be summarized under the following headings:

1. The Thermodynamic "Driving Force".

The most important controls are the temperature of the reaction, the chemical speciation of the solution and the solubility product of the mineral. The solubility of calcite decreases with increasing temperature whereas the solubilities of the calcium phosphate minerals are generally the opposite and increase with temperature. However, for both HAP and OCP, the solubility trends reverse at higher temperatures in the region 15 ± 20 °C. The temperature dependence of the solubility of amorphous TCP or b- TCP is more uncertain.

The degree of saturation, Ω , and saturation index, SI, of a solution with respect to a mineral phase, are defined as:

$$\Omega = IAP / K_{sp} \quad (i)$$

$$SI = \log(\Omega) \quad (ii)$$

where K_{sp} is the thermodynamic solubility product and IAP the ion activity product for the appropriate lattice ions. The saturation index is related to the Gibbs free-energy change for crystallization and is therefore a measure of the thermodynamic driving force for the reaction. The degree of supersaturation with respect to a particular mineral phase may be calculated from the ion-activity product (IAP in Eqn. (i)), and solubility product, K_{sp} . The calculation of the ion-activity product necessitates a detailed knowledge of the chemical speciation of the ions in solution. The high degree of phosphate ion bonding with calcium and magnesium in solution means that ion-pairing is very important to the calculation of the saturation index for the majority of natural and waste waters. This is demonstrated in Figure 1 for a solution of 0.2 mM $\text{Ca}(\text{HCO}_3)_2$ containing 0.2 mM KH_2PO_4 at pH values of 7,8 and 9 at a temperature of 20 °C. The dissociation constants for the ion pairs were as used previously [12]. Both CaHPO_4^0 and CaPO_4^- ion-pairs are important in this pH range and affect the activities of both Ca and phosphate ions used in the calculation of the ion-activity

product. The coordination of Ca ions with other anions such as sulphate and dissolved polyelectrolytes, particularly in waste waters will also affect the calcium activity. An alternative approach is to measure the calcium ion activity directly by using calcium selective electrodes rather than the calcium concentration by standard chemical techniques.

2) Kinetics of the Reaction.

Various regions of solution stability may be defined when the activities of the lattice ions are plotted on a two-dimensional diagram. The solubility line, when $SI=0$, defines the equilibrium between the solution and particular mineral phase. When $SI>0$, and in the absence of epitaxial growth surfaces, the solution is termed metastable so that even though the system is thermodynamically unstable, precipitation of a solid phase does not occur. This occurs widely in aquatic systems; for example, most hard waters are supersaturated with respect to calcite formation with SI values up to 1, i.e. up to ten times supersaturated. At higher supersaturations, heterogeneous nucleation occurs as crystals form on exposed surfaces where nucleation is aided by the symmetry of the surface molecules or ions thus reducing the interfacial energy with the electrolyte. At higher supersaturations, homogeneous nucleation, or spontaneous nucleation occurs. This may not involve the formation of the most thermodynamically stable phase but normally a "precursor phase" with a higher solubility than the stable phase. The formation of the precursor phase may also be in conditions where the composition of the solution and surface charge of the colloid enables the particles to be stabilized in suspension. It is usually difficult to measure discrete reaction rates for the formation of a specific mineral in the region where homogeneous nucleation occurs because of the simultaneous formation of several crystal forms, and conversions between the forms as the supersaturation index of the solution decreases. For example, Feenstra and de Bruyn [13] found that in neutral and slightly alkaline pH conditions, that an amorphous calcium phosphate phase precipitated and served as a template for the heterogeneous nucleation of OCP which in turn lead to the epitaxial growth of HAP.

3) Presence of Growth Inhibitors.

The region of metastability mentioned above, may also arise from the effects of inhibitors interacting with clusters of lattice ions prior to nucleation. Inhibitors may also interact with growing crystals and, depending on the degree of supersaturation of the solution, may prevent growth completely. Many inhibitors are known for calcium carbonate formation e.g. Meyer [14], and for selected inhibitors such as magnesium on HAP and OCP crystallization [15]. In some cases ions are incorporated into the lattice as the crystals grow and subsequently lead to changes in the reaction kinetics, e.g. F⁻ or Cl⁻ for OH⁻ in HAP as well as CO₃²⁻ and SO₄²⁻ for phosphate [16]. In many instances, the effects of the inhibitors on the reaction kinetics may be estimated using the Langmuir equation describing the adsorption of the inhibitor molecules to the crystal surface [2]. Usually the effects of the inhibitor may be overcome by increasing the supersaturation of the solution. Generally, as the inhibitor concentration increases, a critical concentration is reached when growth is completely inhibited [17].

4) Competing Reactions

In fresh- and waste waters there are many competing reactions involving the incorporation of calcium and phosphate in minerals and also in macrophytes and algal cells. Examples include the so called "luxury uptake" of phosphorus by algae [18], formation of solid solutions of iron hydroxide and phosphate in oxic conditions [19], formation of vivianite in anoxic conditions [20], and sorption to aluminium and iron oxides, clays and complexation with organic matter [21]. These reactions lead to changes in the activities of the lattice ions for calcium carbonate and phosphate formation and affect variations in the saturation index of the solution.

5) Localized Conditions.

The presence of surfaces and microbial or algal biofilms in contact with solutions that are supersaturated with respect to particular minerals often lead to localized conditions that are more or less favorable to precipitation when compared with the bulk solution. This has been demonstrated for *Chlorococcum* biofilms in which changes in pH (with increases of up to 1.6) and dissolved calcium were measured over distances of 800 mm above a photosynthetically active surface [22]. These chemical changes occur in the hydrodynamic layer above the biofilm and within the biofilm. In sediments, very large changes in pH, calcium and oxygen concentration have been recorded in the top 1 mm of sediment, [23], [24] and [25]. Calcium gradients in the sediments are often caused by the dissolution of calcium carbonate minerals in the sediments as a result of the low pH caused by high CO₂ concentrations from microbial respiration.

SOLUBILITY ISOTHERMS

Chemical speciation calculations enable the pH dependence of the solubility lines of calcite and the most important calcium phosphate minerals to be compared for particular concentrations of dissolved calcium and phosphate at a chosen temperature. Examples of the isotherms for hard water containing 2.5 mM dissolved calcium bicarbonate and 0.02 mM phosphate at 20 °C are shown in Figure 2. At pH 7 the solution is under saturated with respect to all the phases except HAP. As the pH increases to 9, the solution becomes thermodynamically unstable with respect to both calcite and OCP. In these conditions calcite precipitates and co-precipitates inorganic phosphate. There is no evidence for the formation of OCP in these conditions.

At higher concentrations of dissolved phosphate that are closer to those in waste waters, the supersaturations increase so that at pH=8.2 all the phases except DCPD are theoretically able to form (Figure 3a). This is more clearly seen in Figure 3b with the isotherm for HAP is omitted. The solution remains under saturated with respect to DCPD over the entire pH range; an increase in the phosphate concentration is needed to move the isotherm to positive values of SI .

CO-PRECIPIATION OF PHOSPHORUS WITH CALCITE

The proportion of phosphate co-precipitated depends on the temperature, pH and the concentration of other co-precipitating chemicals.

$$\frac{\text{mass of phosphorus}}{\text{mass of calcium}} = \sigma A h(\text{pH}, \text{Ca}, T) \quad (\text{iii})$$

where s is the maximum surface density of phosphorus (approximately 0.15 mmol m^{-2}) [9, 19], and the function h varies between ca. 0.1 and 0.9. This relationship predicts ratios of Ca : P of between 250 and 60 for precipitation in 0.2 mM $\text{Ca}(\text{HCO}_3)_2$ solution with pH in the range of 8-9 at 20°C and in the presence of between 2 and 20 mM phosphate solution (Figure 4). This leads to concentrations of phosphorus in the precipitate of between 40 and 170 mmol g^{-1} which compare with ca. 6450 mmol g^{-1} for the formation of tricalcium phosphate (Table 1).

PRECIPITATION OF CALCIUM PHOSPHATES IN NEUTRAL TO ALKALINE pH

As shown in Table 1, the phosphorus contents of the minerals are very similar and therefore it necessitates accurate chemical analysis to distinguish between them from changes in the solution composition during crystal growth. At high supersaturations, i.e. $SI > 10$, it is difficult to precipitate HAP alone because of the spontaneous formation of precursor phases such as amorphous calcium phosphates and OCP. At lower supersaturations it has been found possible to nucleate HAP in pH conditions where the solutions are slightly under saturated with respect to amorphous TCP and OCP, e.g. pH 7.4 with total dissolved calcium and phosphate between 0.5-1.7 mM and 0.5-1.0 mM respectively, and SI in the range of 5-10 at ca 27°C . When the growth of HAP is followed in suspensions of crystal seeds of HAP, it is difficult to detect other mineral phases. There is evidence from the shape of growth curves and determinations of the percentage crystallinity that crystal growth on the seeds may progress through precursor phases such as OCP. However, this is difficult to distinguish from adsorption, migration, dehydration and integration of the lattice ions at the surface as the HAP crystals grow. Certainly, there is no evidence for the nucleation of new particles of the precursor phases at these low super saturations. This is because the pH of the suspension is maintained near neutral so that the solution is not supersaturated with respect to DCPD and amorphous TCP but may be slightly saturated with respect to OCP.

Table 1. Comparison of the composition of the main minerals of calcium phosphate

Mineral	Formula	Molar ratio Ca:P	P content/ mmol g^{-1} of crystals
Octacalcium phosphate, OCP	$\text{Ca}_4\text{H}(\text{PO}_4)_3 \cdot 3\text{H}_2\text{O}$	1.33	6000
Tricalcium phosphate, TCP	$\text{Ca}_3(\text{PO}_4)_2$	1.50	6450
Calcium hydroxyapatite, HAP	$\text{Ca}_5(\text{OH})(\text{PO}_4)_3$	1.67	5970
Dicalcium phosphate dihydrate, DCPD	$\text{CaHPO}_4 \cdot 2\text{H}_2\text{O}$	1.0	5810

Generally when homogeneous precipitation occurs, i.e. spontaneous nucleation and growth, unstable amorphous solids precede the formation of crystalline HAP. In conditions when $\text{pH} > 9$, amorphous calcium phosphates (ACPs), are thought to convert directly into HAP whereas at pH 7-9, they are converted to a precursor OCP phase, and then to HAP. The IAP for the ACP formed in alkaline conditions, e.g. $\text{pH} = 7.4-9.25$, has been found to be relatively constant with starting Ca/PO_4 molar ratio of 1.31 to 1.48 and stoichiometry of the solids of $\text{Ca}_3(\text{PO}_4)_{1.87}(\text{HPO}_4)_{0.2}$ [26]. The ACPs contain approximately 10 % HPO_4^{2-} and 10-15% (by mass) water with about 75% of the water tightly bound forming a hydrated salt [27]. The conversion from the amorphous solids to OCP and HAP depends on the temperature and pH of the solution. Although OCP is heterogeneously nucleated on ACP at $\text{pH} < 9.3$, the rapid hydrolysis of OCP to HAP in more alkaline conditions makes it difficult to detect the precursor OCP phase. Hence at higher pH, the conversion from ACP to HAP appears direct without intermediates [26].

Seeded growth methods have been used to investigate the growth kinetics and effects of other ions on the kinetics and morphology of the crystals. For example, the presence of chloride ions in the solution favours the formation of crystal plates of HAP rather than needle-like crystals. Magnesium ions are known to inhibit the growth of HAP and to a less extent OCP but not DCPD. Lithium also inhibits the growth of HAP and is incorporated into the HAP lattice during growth. A range of other inhibitors have also been investigated such as glucose, fulvic, humic, phytic, citric, mellitic and tannic acids. Generally they act by a "site-blocking" mechanism whereby the inhibitors adsorb at growth kink sites, the extent of the coverage of the sites being consistent with the Langmuir adsorption equation [17].

Octacalcium phosphate is a commonly cited precursor phase to HAP formation. Even in the presence of b-TCP seeds, in solutions supersaturated with respect to TCP, OCP and HAP, the OCP phase grows in preference to TCP or HAP [28]. During homogeneous nucleation at high supersaturation (SI for HAP > 20), e.g. $T = 20^\circ\text{C}$, $\text{pH} = 9$, and calcium and phosphate concentrations of 10 and 7 mM respectively, two precursor phases of amorphous calcium phosphate of similar composition to TCP have been identified. The amorphous phases eventually dissolve to form OCP and finally HAP [29]. The crystallization of OCP has also been measured using seeds of OCP in a solution supersaturated with respect to the DCPD, OCP and HAP but under saturated with respect to amorphous TCP. The formation of the amorphous phases is thought to be important to the subsequent development of OCP and may determine whether DCPD also nucleates in preference to OCP. This complex interaction between OCP and DCPD has also been investigated in seeded growth experiments using OCP seeds. At low supersaturations at pH 6 and 25°C , OCP growth occurs, whereas at high saturations, DCPD grows after an induction period, [30].

CONCLUSIONS

There is a need to obtain more fundamental information about calcium phosphate precipitation in complex solutions, and in particular:

- The temperature dependence of the solubilities of the precursor phases, such as the amorphous phases and OCP, over conditions likely to occur in phosphorus recovery plants.
- The stability regions for OCP and amorphous tricalcium phosphate for conditions found in complex solutions such as fresh- and waste waters. This information is necessary to evaluate the optimum conditions for growth in commercial reactors designed for the precipitation of calcium phosphates.
- The effects of the inhibitors, e.g. dissolved magnesium, trace metals and polyelectrolytes, likely to be important in the recovery calcium phosphate from waste waters.

ACKNOWLEDGMENT

The author thanks the Natural Environment Research Council, UK for their support.

LEGEND TO FIGURES

Figure 1. Comparison of the chemical speciation in a hard water (0.2 mM calcium hydrogen carbonate) at 20 °C in the presence of 0.2 mM potassium hydrogen phosphate.

Figure 2. Solubility lines for the main calcium phosphate phases at 20 °C in a hard water of 2.5 mM calcium bicarbonate and 0.02 mM total dissolved phosphate. Key: CAL: calcite, TCP: tricalcium phosphate, DCPD: dicalcium phosphate dihydrate, HAP: calcium hydroxyapatite, OCP: octacalcium phosphate. Thermodynamic data taken from reference [12].

Figure 3. (a) Solubility lines for the main calcium phosphate phases at 20 °C in a hard water (2.5 mM calcium bicarbonate) in the presence of 0.2 mM total dissolved phosphate. (b) as above but excluding HAP. Key: CAL: calcite, TCP: tricalcium phosphate, DCPD: dicalcium phosphate dihydrate, HAP: calcium hydroxyapatite, OCP: octacalcium phosphate. Thermodynamic data taken from reference [12].

Figure 4. Amount of phosphate coprecipitated with calcite at 20 °C in a hard water (2 mM calcium hydrogen carbonate) calculated from equation (3) with the maximum surface density of phosphate = 0.15 mmol m⁻²

REFERENCES

1. Mann, S., Webb, J. and Williams, R.J.P. *Biomineralization. Chemical and Biochemical Perspectives*, VCH, Weinheim. (1989).
2. Brady, P.V. and House, W.A. Surface-controlled dissolution and growth of minerals, In: *Physics and Chemistry of Mineral Surfaces*, Brady, P.V. (ed), CRC Press, Boca Raton, Ch. 4, 225-307 (1996).
3. Drever, J.I. *The Geochemistry of Natural Waters: Surface and Groundwater Environments*, Prentice Hall, NJ. (1997).
4. Wray, J.L. and Daniels, F. Precipitation of calcite and aragonite, *J. Amer. Chem. Soc.*, **79**, 2031-2035, (1957).
5. Slack, J.G. Calcium carbonate hexahydrate: Its properties and formation in lime-softening. *Water Res.*, **14**, 799-804. (1980).
6. Speer, J.A. Crystal chemistry and phase relationship of orthorhombic carbonates. *Review Mineralogy, Mineralogical Soc. America*, vol.11 ch.5. (1983).
7. House, W.A. & Donaldson, L. Adsorption and coprecipitation of phosphate on calcite. *J. Coll. Interface Sci.* **112**, 309-324 (1986).
8. Stabel H. -H. Calcite precipitation in Lake Constance: Chemical equilibrium, sedimentation, and nucleation by algae. *Limnology and Oceanography*, **31**, 1081-1093 (1986).
9. House, W.A. and Denison, F.H. Nutrient dynamics in a lowland stream impacted by sewage effluent: Great Ouse, England. *Sci. Tot. Environ.*, **205**, 25-49 (1997).
10. Koschel, R., Benndorf, J., Proft, G. and Recknagel, F. Calcite precipitation as a natural control mechanism of eutrophication. *Arch. Hydrobiol.*, **98**, 380-408 (1983).
11. Van Kemenade, M.J.J.M. and de Bruyn, P.L. A kinetic study of precipitation from supersaturated calcium phosphate solutions. *J. Colloid Interface Sci.*, **118**, 564-585 (1987).
12. Hartley, A.M., House, W.A., Callow, M.E. and Leadbeater, B.S.C. Coprecipitation of phosphate with calcite in the presence of photosynthesising green algae, *Water Res.*, **31**, 2261-2268 (1997).
13. Feenstra, T.P. and de Bruyn, P.L. Formation of calcium phosphates in moderately supersaturated solutions. *J. Phys. Chem.*, **83**, 465-479 (1979).
14. Meyer, H.J. The influence of impurities on the growth rate of calcite. *J. Crystal Growth*, **66**, 639-646 (1984).
15. Salimi, M.H., Heughebaert, J.C. and Nancollas, G.H. Crystal growth of calcium phosphate in the presence of magnesium ions. *Langmuir*, **1**, 119-122 (1985).
16. Nancollas, G.H. In vitro studies of calcium phosphate crystallization. In: *Biomineralization. Chemical and Biochemical Perspectives*, VCH, Weinheim, ch. 6, pp157-187 (1989).
17. House, W.A. Kinetics of crystallisation of solids from aqueous solutions. In: *Comprehensive Chemical Kinetics Reactions at the liquid-solid interface*, Elsevier, vol. 28, ch.3. (1989).
18. Reynolds, C.S. *The Ecology of Freshwater Phytoplankton*, Cambridge University Press, Cambridge, pp 36.

20. Fox, L.E. Phosphorus chemistry in the tidal Hudson River, *Geochimica et Cosmochimica Acta.*, **55**, 1529-1538 (1991).
21. Sarazin, G, Gaillard, J.F., Philippe, L. and Rabouille, C. Organic matter mineralization in the pore water of a eutrophic lake (Aydat Lake, Puy de Dome, France). *Hydrobiologia*, **315**, 95-118 (1995).
22. Krom, M.D. and Berner, R.A. Adsorption of phosphate in anoxic marine sediments. *Limnology Oceanography*, **25**, 797-806 (1980).
23. Hartley, A.M., House, W.A., Leadbeater, B.S.C. and Callow, M.E. The use of microelectrodes to study the precipitation of calcite upon algal biofilms, *J. Colloid and Interface Sci.*, **183**, 498-505 (1996).
24. Archer, D., Emerson, S. and Reimers, C. Dissolution of calcite in deep-sea sediments: pH and O₂ microelectrode results. *Geochimica et Cosmochimica Acta*, **53**, 2831-2845 (1989).
25. De Beer, D., Schramm, A., Santegoeds, C.M. and Kuhl, M. A nitrite microsensor for profiling environmental biofilms, *Applied Environmental Microbiology*, **63**, 973-977 (1997).
26. Woodruff, S.L., House, W.A., Callow, M.E. and Leadbeater, B.S.C. The effects of biofilms on chemical processes in surficial sediments, *Freshwater Biology* (in press).
27. Eanes, E.D. Amorphous calcium phosphate: thermodynamic and kinetic considerations. In: *Calcium Phosphates in Biological and Industrial Systems*, Amjad, Z (ed.), Kluwer Academic Publisher, ch.2 (1998).
28. Sedlak, J.M. and Beebe, R.A. Temperature programmed dehydration of amorphous calcium phosphate and crystalline hydroxyapatite. *J. Colloid Interface Sci.*, **47**, 483-489 (1974).
29. Heughebaert, J.C., Zawacki, S.J. and Nancollas, G.H. The growth of octacalcium phosphate on beta tricalcium phosphate, *J. Crystal Growth*, **63**, 83-90 (1983).
30. Christoffersen, M.R., Christoffersen, J. and Kibalczyk, W. Apparent solubilities of two amorphous calcium phosphates and octacalcium phosphate in the temperature range 30-42 °C, *J. Crystal Growth*, **106**, 349-354 (1990).
31. Heughebaert, J.C., De Rooij, J.F. and Nancollas, G.H. The growth of dicalcium phosphate dihydrate on octacalcium phosphate at 25 °C, *J. Crystal Growth*, **77**, 192-198 (1986).

Full scale phosphate recovery at sewage treatment plant Geestmerambacht, Holland

Ir. Simon Gaastra, Ir. Ruud Schemen, Piet Bakker and Ing. Mathieu Bannink
Waterboard "Uitwaterende Sluizen in Hollands Noorderkwartier"
Post-box 14, NL - 1135 ZH Edam, Holland

Telephone : ** 31 (0) 299 391 424
Fax : ** 31 (0) 299 391 189

Email : websg@ushn.nl

1. Introduction; waterboard US

The waterboard "Uitwaterende Sluizen in Hollands Noorderkwartier" (US) was founded in 1544. Since 1993 it is an all-in waterboard in the north-western part of Holland, which is responsible for:

- quality control of all surface waters;
- water quantity (level) control;
- maintenance of dikes and dunes (in order to keep "dry feet" in the area);
- maintenance of the roads in several communities.

Its a semi-public organisation, a democratic institution. That means that it has a general board (48 members, the "hoofdingelanden"), which is chosen by all who have interests in the work of the waterboard (inhabitants, industries, communities, farmers). The chairman ("dijkgraaf"), however, is appointed by the Queen. The general board takes all decisions. Uitwaterende Sluizen has about 425 employees.

In order to control the quality surface waters (canals, lakes, ponds, streams) US fulfils several tasks: the formulation of the policy, the planning of actions and projects, the legislation (discharge of sewages is forbidden without a permit), and the treatment of sewage and by-products. Until now the communities collect the sewage from households and industries, the waterboard transports and treats it.

US operates 20 central sewage treatment plants (STPs), 125 pumping stations, 350 kilometres of pressure pipelines and a sludge drying installation. The STPs have a total capacity of 1,76 million population equivalents (pe; 1 pe equals 136 g TOD). We serve a area of about 200.000 hectares , with circa 1,3 million inhabitants (430.000 households) and 25.500 industries. With the planning and operation of the facilities about 80 people are employed.

Based on the Dutch Water Pollution Act the waterboard collects a fee from all inhabitants and industries in the area, based on the principle: who pollutes, pays. At the moment the fee is 100 / pe (£28,50 or 45 euros).

Since US is responsible for water quality control and is spending public money, important drives with the operation of the treatment plants are:

- meeting the effluent standards, and
- meeting the average reduction value for Ptotal (and starting in 2003 for Ntotal as well), and
- cutting the costs (public money!).

2. P-removal from sewage at US

Based on the Water Pollution Act waterboard US handles a set of effluent standards for each of its STPs. For instance for total phosphorus (Ptotal) it is 1 or 2 mgP/l in the effluent (depending on the capacity of the plant; averaged over 10 measurements).

Since 1995 all waterboards in Holland have to meet a reduction of 75% for Ptotal, as a yearly average over all STPs operated (influent ----> effluent). In a few years this reduction of 75% has to be achieved for total nitrogen (Ntotal) as well.

To meet the mentioned reduction of Ptotal waterboard US chose about ten years ago to implement in principal chemical phosphate removal (simultaneous or preprecipitation), because its a simple and reliable process. So at 7 STPs chemical installations were built and are in operation now.

However, for STP Geestmerambacht biological P-removal in a sidestream process plus crystallizers was chosen. Reasons were:

- the potentials for phosphate recovery in an separate stream, thus enabling recycling of phosphate, and
- co-operation in the development of a new process: crystallisation of calciumphosphate from sewage.

Due to the potentials of the process the waterboard received governmental financial support for the project.

In 1997 waterboard US treated 795 ton of Ptotal; about 65% was treated via chemical removal, 10% was treated at STP Geestmerambacht and 25% at the other 12 STPs. The overall removal of Ptotal performed was 77%.

3. Biological P-removal and crystallizers at STP Geestmerambacht; experiences

STP Geestmerambacht: sewage and sludge treatment

STP Geestmerambacht was built in 1973 and was extended and upgraded two times; in 1994 the existing plant was ready and started up. The STP treats the sewage from inhabitants and industries (80 and 20%, respectively). The design capacity of STP Geestmerambacht is 231.600 pe (equals with 340 kg Ptotal/d) and 5.000 m³/h (RWF). For capacities and loads in 1997 see **table 1 (STP Geestmerambacht; process data 1997 (average values))**.

The main parts of Geestmerambacht are shown in **figure 1 (Flow scheme)**. The water treatment process mainly takes place in an activated sludge system, consisting of:

- Anaerobic selector (selection of sludge with good settling properties);
- Denitrification tank (in the new part of the STP);
- Two oxidation tanks (Carrousel® with point aerators; also fine bubble aeration in old tank);
- Six sedimentation tanks.

The main parts of the sludge treatment are:

- Three gravity thickeners;
- Homogenizer tank;
- Two dewatering decanters;
- Two dewatered sludge bunkers.

The dewatered sludge is transported to and dried at a central sludge drying installation (SDI). The dried sludge is still tipped; tests are conducted for co-incineration at an energy plant.

Phosphate removal at Geestmerambacht

The phosphate removal at Geestmerambacht in fact is a combination of biological and physico-chemical techniques. Phosphate (orthophosphate plus organic phosphate) is transported to the STP with the influent. The biomass in the activated sludge process is using P for cellgrowth, which is quite natural for bacteria to do. However, by subjecting the sludge to a sequence of aerobic and anaerobic conditions, bacteria are grown which use polyphosphate as an energy-carrier. Here they are called the P-bacteria.

Under the aerobic conditions in the oxidation tanks the phosphate from the influent is incorporated by the P-bacteria in polyphosphates. A part of the return sludge is pumped to the (anaerobic) strippertanks in the sidestream (see **figure 2: scheme of sidestream**).

By splitting off orthophosphate ions the P-bacteria are able to use fatty acids as carbon source under these conditions. The orthophosphate is going into solution. To stimulate this process acetic acid is dosed (solutions of 70 to 85%). The pH-level is controlled at about 7,3 by dosing of sodium hydroxide (NaOH).

Next the stripped sludge and the phosphate-rich water (50 80 mgP/l) are separated in a gravity thickener. The separation process is controlled by a sludge blanket measuring device. The sludge is returned to the activated sludge system; the supernatant goes to the physico-chemical process.

First, in order to reduce the formation of calciumcarbonates, the carbonates are stripped in a cascade stripper. The pH-value should be controlled at about 5 to shift the equilibria to CO₂ (in practice about 3,5, due to a technical problem), by the dosage of sulphuric acid (96% solution). The stripped supernatant is collected in the buffer tanks before the crystallizers.

Figure 3 shows the **principle of the crystallizer reactor**. The process and reactor are developed by DHV Water BV, Amersfoort, Holland, under the name Crystalactor®. The reactor consists of a vertical cylindrical vessel, partially filled with a fluidised bed of seeding material, in this case filter sand. The water is pumped through nozzles into the reactor (vertical velocity about 40 m/h). Also in the bottom Ca(OH)₂-solution is added via separate nozzles, to provide an elevation of the pH-level and Ca-ions. Through the high turbulence a good mixing of P-rich water and solution is obtained. Crystallisation of calciumphosphate takes place mostly on the seeding sand, by which the pellets grow. Dosing of calcium hydroxide is controlled by pH-measurement (pH about 8). The crystallisation efficiency is enhanced by recirculation over the pump wells; by recirculation 2,5 3 times the crystallisation efficiency is circa 70%.

The bed height is controlled at 4 4,5 metre. The height is adjusted by extracting pellets near the bottom and subsequently adding new seeding sand.

Experiences

The side stream process, including the crystallizers, is working well at the moment, and can be controlled by the people at STP

Geestmerambacht. Since the operation of the sidestream process (dosing of several chemicals to keep setpoints in a narrow range; finding the right level of setpoints; little biomass to be pumped to crystallizers) differs substantially from the processes normally applied at STPs, getting familiar with the process took some time. Anyhow: the team at STP Geestmerambacht gathered lots of experience, also by solving some problems!

The process was started up in 1994: first the biological part and next the cascade stripper and crystallizers. Also since application of the process in the sidestream was new, and the plant was built as a demo site, some technical problems had to be overcome. Not all of them had a direct relation with the sidestream process. Lots of problems in the control system of the STP had to be solved. In the first year the plant had to be operated, without all measurements at the STP being ready.

Severe were the problems with the water nozzles in the crystallizers. Two times heavy abrasion of these nozzles occurred. In the beginning of 1996 we installed new ones of another material and with 3 instead of 12 borings, and since then we don't see abrasion of them anymore.

Two times we had problems with the formation of columns of "glued" pellets in the reactors, probably related to the problems with the nozzles and the control of the system. The reactors had to be emptied and were started again.

Algae grew on the rims in the top of the reactors; this growth wasn't seen as a big problem.

Clogging problems with the return sludge pumps, which caused shut down of feeding pumps. By changing the control system the problem was solved.

From the "outside world": problems with an industry. The sewage, rich of phosphate, was discharged in batches. The P-loads in the influent of STP exceeded the design capacity (1000 kgP_{total}/d versus capacity 340 kgP_{total}/d). Since 1997 this factory is performing chemical P-removal, and the sewage is transported to another location.

Investment and costs; production of pellets

The total investment for the sidestream process was about 9,3 million (£ 2,7 million or 4,2 million euros). The Dutch government supported US for this project with 2,0 million.

The costs of phosphate-removal from the sewage are about 16 / kgP_{removed} (£4,6 or 7,3 euro / kgP_{removed} ; in 1996). Capital costs are firm: about 55% of total. The build-up of the variable costs (45% of total) is given in **figure 4 (Variable yearly costs (%))**.

Production of phosphate pellets in 1998 will be 180 240 tons. The pellets consist for about 11% of P (average). At the moment the pellets are re-used in the production of chicken feed.

4. Possibilities for optimisation at STP Geestmerambacht

Several possibilities are seen to optimise the process of phosphate removal at STP Geestmerambacht. At the moment we are optimising the dosing of acetic acid; the specific dosage is about 15 g/kg ds. Parallel with the reduction of HAC-dosage and with a chosen pH-level the dosing of sodiumhydroxide is reduced. These chemicals form about 44% of the variable costs.

Due to technical problems the dosing of sulphuric acid for CO₂-stripping is higher than necessary. By solving the usage of this chemical and parallel of calciumhydroxyde can be diminished; at the moment both make about 13% of the variable costs.

Further reduction of costs could be obtained if we get hold of alternative carbon sources, instead of the batches HAC-solutions we buy at the moment. A very good variant would be to use specific industrial effluents (we receive these sewages, diluted in the influent, anyhow), or to produce acetic acids from the influent. This has to be looked at.

An alternative process, the introduction of denitrifying phosphate-removal, will be studied.

Optimisations of the side stream process with crystallizer

The plant at Geestmerambacht was designed in 1991, and was built as a demo location. Anno 1998 we have gathered a lot of experience, with which we could design a simpler and more effective plant. As a result the investment and capital costs can be reduced, with about 5 - 10%. The specific costs of phosphate removal would go down with about 2,5 - 5 %.

STP Geestmerambacht is underloaded at the moment (60-65% of design capacity), and so is the sidestream process. At the moment one crystallizer is shut down, and acts as a reserve. For that reason the (specific) costs of phosphate removal are relatively high. If the capacity of the process would be used completely, the specific costs could be reduced.

With the above mentioned optimisations the costs of the process are estimated at about 13-15 / kg P_{removed} (£3,7-4,3 or 5,9-6,8 euro / kg P_{removed}).

5. Conclusions

The conclusions, after gathering first-hand experience with the sidestream process, including crystallizers, are:

- The process can be operated satisfactorily, after solving some operational and technical problems;
- The process should be operated carefully, like in a physico-chemical industry;
- Costs of P-reduction at STP Geestmerambacht are 16 / kgP_{removed} (£ 4,6 or 7,3 euro / kgP_{removed});
- By optimisation costs could be about 13 15 / kg P_{removed} (£3,7 4,3 or 5,9 6,8 euro /kg P_{removed}).
- The phosphate pellets can be re-used !

Literature

Piekema, P.G. and Gaastra, S.B.: Upgrading of a wastewater treatment plant in the Netherlands: combination of several nutrient removal processes. European Water Pollution Control, 3 (1993), nr. 3, 21 - 26.

REMOVAL OF PHOSPHATE FROM SEWAGE AS AMORPHOUS CALCIUM PHOSPHATE

R.ANGEL*

ABSTRACT

This short paper discusses the progress of laboratory scale and a larger pilot plant campaign directed at evaluating a new process for the removal and recovery of phosphate from municipal sewage (after secondary treatment) and certain industrial waste streams. The laboratory scale experiments (conducted at flow rates up to 75 L/hr) on real sewage (total P around 10 mg/L) and on a variety of simulated industrial and sewage streams (total P up to 160 mg/L) were very successful in removing phosphorus to >98%, and produced a phosphate containing "product" containing up to 16% elemental P (ie around 80% $\text{Ca}_3(\text{PO}_4)_2$).

However, when tested in the field with real sewage (flow rate 2,000 L/hr) the overall results were disappointing. Although phosphorus removal was excellent and achieved expectations (>95% removal of P from the sewage stream), the phosphate levels in the "product" were far below those achieved in the laboratory work. This had dramatic effects on reagent utilisation and negative impact on the economic evaluation of the project.

Also, despite general similarities between the process design and equipment used in both the laboratory scale and pilot plant equipment, during the pilot plant tests operational problems were encountered which were not anticipated from the laboratory scale work.

The reasons for the discrepancies between the results obtained from laboratory and field experience are discussed with reference to a number of factors including - 1. functional differences in certain equipment (ie filter units), and differences in physical scaling factors between laboratory and pilot plant operations,

2. the effect on field operations of unforeseen components in real effluents -specifically high bicarbonate levels and the presence of propionic acid, and,

3. inadequate flexibility in the construction of the pilot plant which precluded easy changes to plant configuration and introduction of new equipment. The pilot plant used in this work was built in a very robust manner, which is unsuitable for an experimental facility and better suited for construction of plant to continuously demonstrate an already proven process. Although this paper deals specifically with the development of one process for the removal/recovery of phosphate, many of the types of problems and discrepancies encountered are generic to scale up campaigns. In many cases problems could have been avoided by better thought out pilot plant design (particularly in regard to flexibility for changes to configuration and the introduction of new or improved equipment), and well defined expectations as to where the new process may be finally implemented. It is also necessary for project managers and administrators who initiate pilot scale projects to be properly aware of the technical and economic performance required of a new process in particular operating environments.

All personnel involved in development (including project managers) should have an appropriate understanding of the chemical, physical and engineering factors underlying successful process development, and a clear view of how full scale implementation of a new process fits with existing infrastructure.

This paper will attempt to demonstrate, with reference to the field data, how these factors impacted on the outcomes of the pilot plant campaign, and with reference to hindsight, how such a campaign could be more satisfactorily undertaken.

INTRODUCTION AND BACKGROUND

1. PROCESS DESCRIPTION It is well known that aqueous phosphate can be very effectively precipitated as calcium phosphate under conditions of high pH and with an excess of Ca^{2+} ions. The addition of hydrated lime [$\text{Ca}(\text{OH})_2$] is very effective in achieving both conditions, but when implemented on a large scale (e.g. in the context of sewage treatment with flows measured in megalitres per hour) has the disadvantage that the precipitate is slow to settle and hence to remove from the major streams and, due to its high solubility addition of lime makes control of effluent pH difficult.

At the outset of the present project laboratory studies established that by passing a sewage stream - suitably supplemented with Ca^{2+} if required - in an up flow manner through a suspension of fine magnesium oxide particles could produce a well defined "bed" containing a mixture of amorphous $\text{Ca}_3(\text{PO}_4)_2$ and magnesium hydroxide. This bed had high integrity, in that very little particulate material flowed out of the reactor with the effluent stream. Magnesium oxide is far less soluble and a less caustic alkali than is $\text{Ca}(\text{OH})_2$, and allows for good pH control in the reactors and in down stream process unit operations.

The phosphate containing "product" could be easily recovered from the reactor subsequent to filtration, and consequently offered potential for recycling of phosphorus - either as a fertiliser or for introduction into other industrial sectors. The major features of the process and reactor configuration are depicted in Fig.1.

While this project was initially conceived as a method for removing phosphate to low levels (typically 0.1 - 0.3 mg/L) from sewage effluent released into sensitive receiving waters, it shows promise as a method for removal and recovery of phosphorus from other phosphate containing waste streams.

2. PROCESS CHEMISTRY

The operative chemistry for precipitation of the calcium phosphate from the waste stream is very simple and can be summarised conceptually in the following series of equations

-

OPERATIVE "CONSTANTS"

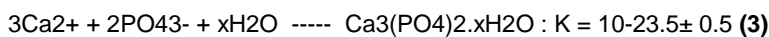
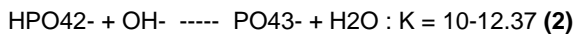
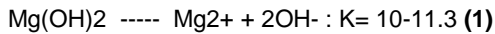
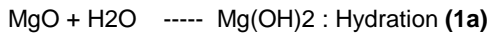

The equilibrium constant listed above for formation of the amorphous calcium phosphate was determined in preliminary beaker experiments, and is in agreement with that determined by Roques et al (ref 1). It has been found to be generally applicable throughout this work, although in some cases this parameter may need to be corrected to allow for the effects of background ionic strength.

During operation of the process the amorphous calcium phosphate deposits around, and becomes loosely adsorbed onto the fine particles of MgO forming a low density "calyx" around these particles. Thus the role of the MgO in this process is twofold - firstly to provide (through equation 1) an environment where the pH is around 10 - 10.3 which drives equation 2 to the right, allowing sufficient concentration of PO₄³⁻ for the calcium phosphate formation of equation 3. The second function of the MgO is to provide a substrate around which the calyx forms, thus allowing for the formation of a reasonably compact and intact mixed bed of reactants and products.

A simplified model based on the equilibria denoted in the equations above allows estimation of the effluent phosphorus levels as -

$$\text{Pres} = 0.46 \times [(1 + 10^{(12.37 - \text{pH})}) / (\text{Ca}_{2+\text{res}})^{1.5}] \text{ (4)}$$

where Pres and Ca_{2+res} are respectively the residual dissolved phosphorus and calcium ion concentrations (in units of mgL⁻¹) in the reactor effluent.

Obviously for low effluent phosphorus levels an excess of Ca²⁺ is required, and typically with an excess of 80 mgL⁻¹ of Ca²⁺ in the reactor effluent, residual phosphorus levels could be maintained at below 0.3 mgL⁻¹ which was the target set for sewage discharge into the Hawksbury river near Sydney.

Sewage and other waste streams also contain other reactive constituents such as carbonate and ammonium ions which react with the MgO and Ca²⁺ in side reactions producing calcite and converting NH₄⁺ to neutral ammonia. ie

-

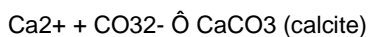
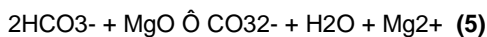

and -

$2\text{NH}_4^+ + \text{MgO} \rightleftharpoons 2\text{NH}_3 + \text{H}_2\text{O} + \text{Mg}^{2+}$ (6) The presence of these components also consumes reactive MgO, and consequently must be considered when evaluating process economics. Other processes which are "parasitic" on the active MgO may also be possible under certain circumstances, and in particular the conversion of MgO to Mg(OH)₂ is an important under certain circumstances. In respect of this, magnesium hydroxide (particularly when in the form of the crystalline mineral brucite) is relatively inert, and since it is only slowly soluble is unable to maintain a high pH in a relatively fast moving process stream.

1																	2
H																	He
3	4											5	6	7	8	9	10
Li	Be											B	CO ₃	NH ₄	O	F	Ne
11	12											13	14	15	16	17	18
Na	Mg											Al	Si	PO ₄	SO ₄	Cl	Ar
19	20	21	22	23	24	25	26	27	28	29	30	31	32	33	34	35	36
K	Ca	Sc	Ti	V	Cr	Mn	Fe	Co	Ni	Cu	Zn	Ga	Ge	As	Se	Br	Kr
37	38	39	40	41	42	43	44	45	46	47	48	49	50	51	52	53	54
Rb	Sr	Y	Zr	Nb	Mo	Tc	Ru	Rh	Pd	Ag	Cd	In	Sn	Sb	Te	I	Xe
55	56	57/71	72	73	74	75	76	77	78	79	80	81	82	83	84	85	86
Cs	Ba	La-Lu	Hf	Ta	W	Re	Os	Ir	Pt	Au	Hg	Tl	Pb	Bi	Po	At	Rn
87	88	89/103	104	105	106	107	108	109									
Fr	Ra	Ac-Lr	Rf-Ku	Ha-Ns	Unh	Uns	Uno	Une									

LABORATORY TRIALS

1. EQUIPMENT The definitive laboratory trials were performed in a test rig capable of continuous operation at a throughput of 12 - 100 L/hr. The flow sheet is given in Fig 2. The heart of the equipment was the reaction column (diameter 17.6 cm, total volume 38 L) which was fitted with a conical base section (half angle 140) through which the influent was introduced. The equipment also incorporated facilities for removal of influent carbonate and flocculation of solids carried out of the reactor with the effluent.

During the laboratory trials the influent was augmented with calcium when required with solutions of CaCl₂ or addition of CaSO₄ (solubility around 0.7 gm.L⁻¹). If required carbonate could be very effectively removed from the influent through addition of H₂SO₄ to pH around 5, and sparging with air.

Flow through the system could be accurately controlled and monitored between 6 and 100 L/hr using a variable speed pump (DC motor) and rotameter.

FIG 2.

LAB. TEST RIG FLOWSHEET

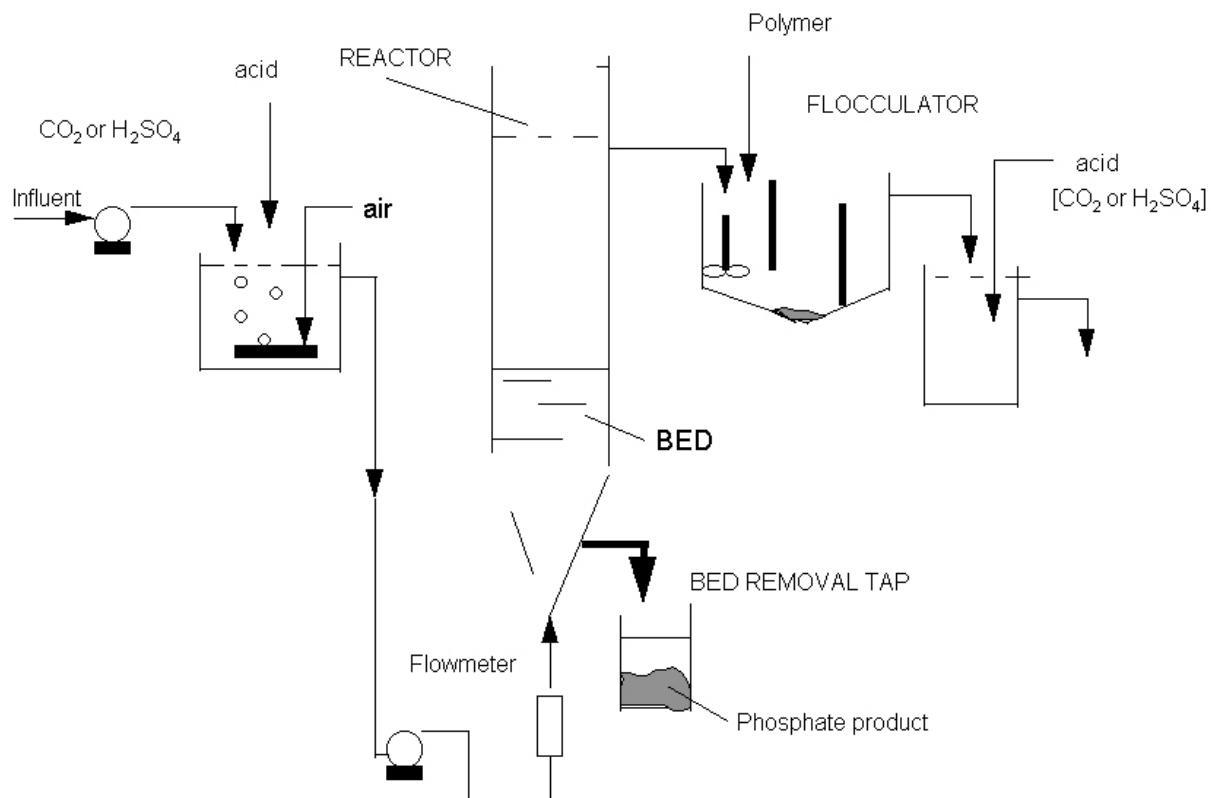

Most experiments were conducted at 50 L/hr which corresponds to a reactor superficial velocity of 2 m/hr. At this modest flow rate little solid material sloughed off the bed and was carried out with the effluent, but at higher flow rates the proportion of material carried out with the effluent increased. However, this material could be readily flocculated through addition of anionic polyacrylamide flocculant (added at between 0.5 and 2 mgL⁻¹) which was effected in a combination flocculation/sedimentation vessel of around 6 L capacity.

The magnesium oxide used in these experiments was a commercial product sold as EMAG 75, which has a particle size distribution such that 95% (weight) has particle diameter less than 75 micron, and a mean particle diameter of around 25 micron. During the laboratory experiments the MgO was not added continuously, but was added in batches of freshly made slurry in water (approximately 30% w/w) - each batch usually containing 50 gm of MgO. Typically the pH of the reactor effluent was 10.8 - 10.9 at the start of an experiment, but this rapidly fell to an "equilibrated" value of 10.2 - 10.5 where it remained for several hours, before rapidly dropping to values below 10. The MgO was replenished if necessary after the effluent pH had fallen below this value.

All trials were conducted at ambient laboratory temperature of 23± 2 oC.

2. RESULTS

Although development of the process was initially directed towards implementation in the treatment of sewage, it was realised that there was significant potential for treatment of other waste streams. Accordingly a variety of different influent compositions were tested, with over forty different laboratory trials completed. The summary of the range of influents and experimental conditions is given in Table 1.

These tests were designed to investigate the effects of flow rate, influent composition and other factors on overall process performance, or to replicate some of the latter pilot plant trials on the laboratory scale.

TABLE 1

FLOW RATE	Influent P [as ortho-phosphate]	Influent Ca ²⁺	Influent HCO ₃ ⁻	Influent NH ₄ ⁺

25 - 75	6 - 160 mgL ⁻¹	80 - 400 mgL ⁻¹	30 - 240 mgL ⁻¹	0 - 50 mgL ⁻¹
Litre/hour				

It is not appropriate to discuss the results of each individual test here, but the major conclusions are summarised and discussed below.

A] EFFICIENCY OF MgO UTILISATION

Given an initial influent composition, the theoretical stoichiometric rate of MgO consumption can be calculated for a particular flow rate through use of the equations above. An analysis of thirty four of the available data sets is displayed graphically in Fig 3 where the experimental rate of MgO usage is plotted against the calculated rate assuming the MgO is entirely consumed in the various acid neutralisation reactions. Although there is some scatter in the data, regression analysis furnished the linear relation -

$$\text{MgO used} = 2.1 \text{ MgO calculated.}$$

The slope of the plot of observed MgO use rate against the calculated rate is 2.1 (with correlation coefficient 0.46), which translates to a mean MgO utilisation of 48%. However, there was appreciable scatter, and the usage rates for individual trials ranged between a minimum of 18% and a maximum of 70%.

Despite the large quantity of available data it was not possible to make definite correlation's between high utilisation rates and influent composition,

FIG.3

CORRELATION BETWEEN CALCULATED AND

OBSERVED USAGE RATE OF MgO.

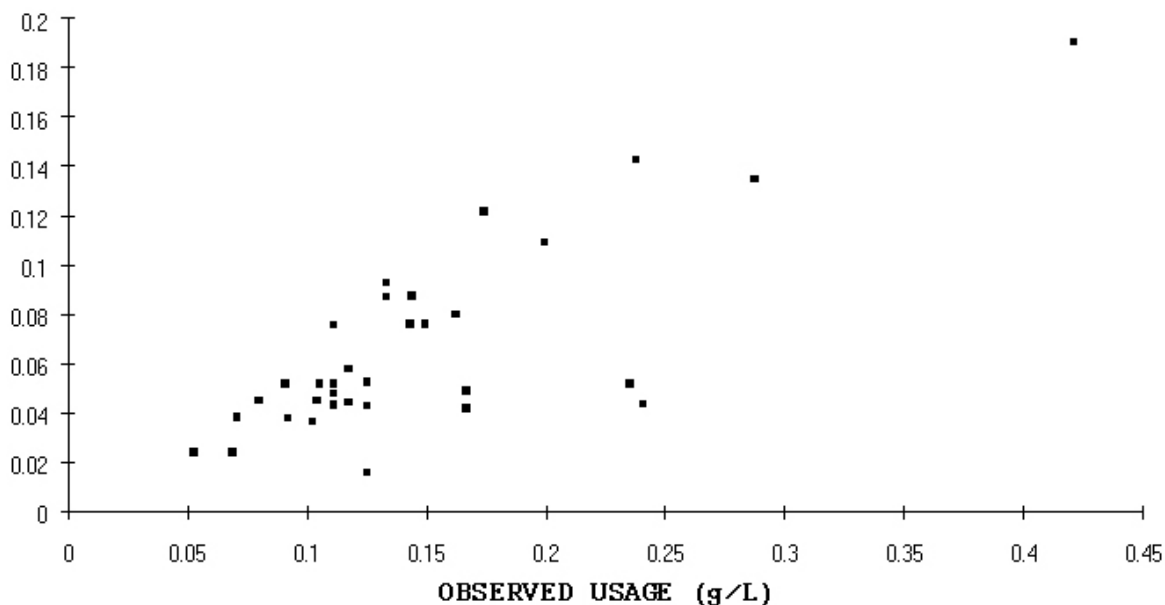

but there was some evidence that high intrinsic MgO demand (ie high phosphate and/or high carbonate concentrations) in the influent favoured higher percentage utilisation of the MgO.

B] PRECIPITATION OF CALCITE -

FROM HIGH BICARBONATE INFLUENT

Under the high pH conditions in the reactor (pH>10) any bicarbonate present in the influent will be converted to carbonate. The solubility constant for calcite is around 10^{-8.3} mole².litre⁻², and given that ambient calcium levels in the reactor effluent were typically around 0.002M (ie 80 mgL⁻¹) precipitation of calcite could have been anticipated with influents containing even low carbonate concentrations. In fact the bicarbonate concentration of the influent streams varied between 30 and 240 mgL⁻¹ (ie

0.0005 and 0.004 M), and consequently significant deposition of calcite into the reaction bed and onto the equipment surfaces could have been expected. Surprisingly, very little calcite was deposited even during those tests conducted with high influent bicarbonate levels. Some scale did form in the flocculator/settler (Fig 2), but this was significant only after prolonged standing (eg 12-24 h). Analysis of the solid products removed from the reactor also indicated some calcite precipitation in the reaction bed, but always at levels far below those that could have been expected considering the degree to which calcite was supersaturated in the process liquors. Some illustrations and examples of this are discussed further below.

It is clear that although the solutions were almost always highly supersaturated with respect to calcite, there appeared to be some factor operating to maintain the system in a metastable (or at least kinetically

sluggish) condition. An early paper by Ferguson and McCarty (ref. 3) indicated that the presence of Mg²⁺ in solution acts to inhibit CaCO₃ crystallisation. Since our reactor solutions contained between 20 and 120 mgL⁻¹ dissolved magnesium - as consequence of the reactions of hydrogen phosphate, bicarbonate etc with the MgO - this seemed a very satisfactory explanation of the slow calcite deposition encountered during the laboratory work.

However, in subsequent larger scale test work with the pilot plant equipment - see below -, very severe scaling problems plagued the early trials, and it appears that other factors may also be operative in influencing the rate of calcite precipitation.

C] COMPOSITION OF SOLID REACTOR "PRODUCTS"

At the end of each laboratory trial the solid reaction products retained in the reactor were removed as a slurry, filtered and dried at 105 oC, a procedure that removed all but the most firmly bound water. In more than half the cases (specifically from 23 tests) the dry solids were analysed for phosphate, calcium and magnesium content.

The solids are mixtures of amorphous calcium phosphate, calcium carbonate and magnesium hydroxide together with some strongly bound water. The relative proportions of these constituents in the solid products reflects to some degree the composition of the influent streams, and for the solids analysed resulting from the various tests the composition range was -

P, Elemental phosphorus : 6.5 - 18.3%

Ca₃(PO₄)₂, Calcium phosphate : 31 - 90%

CaCO₃, Calcium carbonate : 0 - 41%

Mg(OH)₂, Magnesium hydroxide : 5 - 53%

Water : 6 - 28%

As would be expected, the highest phosphate containing products resulted from treatment of influent containing low carbonate. However, the high calcium phosphate content attainable in some cases strongly supports the possible that this general type of process may be utilised for the economic recovery and reuse of phosphate from waste streams

It is also of interest that for those solids resulting from treatment of secondary sewage, the heavy metal content is very low, and this points to the possibility for introducing such recovered products into "metal sensitive" markets - eg organic fertilisers. The range of heavy metal content for three products

prepared from treatment of secondary sewage effluent (Sydney) is given in Table 2 below.

TABLE 2

%Cu	%Pb	%Zn	%Fe	%Mn	%Al	%Cd	%Si
0.01 -0.03	0.02	0.02 - 0.06	0.1 - 0.2	0.03 - 0.1	0.05 - 0.2	<0.0005	0.5

D] RESULTS FROM TWO "REPRESENTATIVE" TESTS

As an example of the considerations discussed above, the results for two particular laboratory tests will be summarised here. These two trials were selected since they were conducted as analogies to test regimes adopted during the large scale pilot plant campaign at Warriewood sewage treatment plant near Sydney.

The influent used in these two tests was made up to simulate the sewerage effluent from this plant which has a high ammonia content. The two influent

TABLE 3**INFLUENT PARAMETERS and OPERATING CONDITIONS**

Both tests conducted at flow of 50 L/hr, which is equivalent to a reactor superficial velocity of 2 metre/hour.

Each test conducted using a reactor charge of 50 gm. of MgO

For Trial 1 MgO consumption was 200 mg.L-1.

For Trial 2 MgO consumption was 133 mg.L-1.

	P influent	HCO ₃ ⁻ influent	NH ₄ ⁺ influent	Ca ²⁺ influent (as CaCl ₂)	<u>influent HCO₃⁻</u> <u>influent P</u>
TEST 1	9 mg.L-1	150 mg.L-1	50 mg.L-1	100 mg.L-1	16.6
TEST 2	9 mg.L-1	30 mg.L-1	50 mg.L-1	100 mg.L-1	16.6

EFFLUENT PARAMETERS

pH of effluent always between 10.0 and 10.5

	P effluent	HCO ₃ ⁻ effluent	NH ₄ ⁺ effluent	Ca ²⁺ effluent	Mg ²⁺ effluent	% MgO USED IN REACTION
TEST 1	0.1-0.4 mg.L-1	130 mg.L-1	ND	56-85 mg.L-1	56-64 mg.L-1	54.3
TEST 2	0.2-0.3 mg.L-1	LOW	ND	66-87 mg.L-1	40-54 mg.L-1	64.9

PARAMETERS FOR REACTOR SOLIDS

	% Ca ₃ (PO ₄) ₂	% CaCO ₃	% Mg(OH) ₂	% H ₂ O	<u>wt. CO₃ in solid</u> <u>wt. P in solid</u>
TEST 1	33.6 (6.9% P)	21.9	33.6	10.9	1.9
TEST 2	51.2 (10.5% P)	ND	ND	ND	ND

compositions differ only in the content of carbonate, and all the pertinent data is tabulated in Table 3.

The percentage use of the MgO in reaction with HPO₄²⁻, HCO₃⁻ and NH₄⁺ was high in both cases, and it can be assumed that the un-reacted MgO was converted to residual Mg(OH)₂.

The high concentration of Mg²⁺ in the reactor effluent reflects the high NH₄⁺ in the influent (according to equation 6 above, 50 mg.L-1 of NH₄⁺ in the influent is equivalent to 35 mg.L-1 of Mg²⁺ in the effluent).

Phosphorus in the reactor effluent was successfully removed to levels around 0.3 mg.L-1, which amounts to a removal/recovery efficiency of better than 96%.

While the ratio of HCO₃⁻/P in the influent of Test 1 was around 19, the ratio of carbonate to phosphorus in the resultant solids was only 1.9, a factor of ten

less. This observation illustrates the inhibition of calcite deposition in these systems, a general observation which was discussed above.

The calcium phosphate content of both solid products was respectable, and was higher for Test 2 which contained no carbonate in the influent, and presumably no calcite in the residual solids (calcite content was not determined in this case).

The successful outcome of the laboratory tests which showed the process to be highly effective in removing phosphorus from waste streams, and of recovering the phosphate into a potentially useful product suggested larger scale pilot plant trials should be undertaken. The object of such pilot scale trials would be to investigate the technical and economic viability of large scale implementation.

PILOT PLANT CAMPAIGN

In 1994 Sydney Water Board (now Sydney Water) together with the Australian Dept. of Industry, Science and Technology (DIST) jointly funded a project for the design, construction and operation of a pilot plant which would test the process on secondary treated sewage from treatment facilities owned by Sydney Water. The contribution from DIST was made under the auspices of a mutual agreement between Australia and Germany designed to foster developments in environmental technology of interest to both nations.

1. PILOT PLANT DESIGN AND OPERATION

A brief description of this plant has been published previously (ref.4), but a more detailed account is given here.

The plant was conceptually designed as a greatly enlarged version of the laboratory equipment with capacity to handle flows up to 10 m³ per hour, and the flow sheet is reproduced in Fig.3.

The plant was built around two cylindrical fibreglass reinforced plastic reactor vessels of 2.5 m³ capacity and 0.785 m² cross sectional area. These vessels were fitted with a conical base section with half angle 60°, which was significantly more obtuse than for the corresponding conical section of the laboratory equipment. The two reactors could be operated in parallel, in series or independently.

As in the laboratory equipment, the influent was introduced from the bottom of the cone section, but there was also provision for other modes of influent introduction.

The flocculator/settler of the laboratory scale gear was replaced with a moving sand filter (Dynasand) and, although found unnecessary, polymer could be introduced upstream of this filter by direct injection into an in-line mixer. This continuous filter operates on an air lift principle and was found to be very effective in reducing suspended solids, with typical removal of 95% of the fine particulate matter carried out of the reactors. The filter backwash containing the particulate material comprised 10 - 15% of the total plant flow and was returned to the solids holding tank - see Fig.3.

All peripheral tanks used for interim storage, solids settling and reagent make up etc. were constructed of fibreglass reinforced plastic, while the plumbing connections between the tanks, pumps etc were made of 50 mm high density polyethylene pipe.

Flow rate through the plant was controlled by variable speed screw type (Mono) pumps, while other major liquid transfer operations were handled by centrifugal pumps.

The plant was fitted with a variety of monitoring and control equipment with the aim of allowing for unattended operation. In practice operational problems which became apparent during the trials, together with the unreliable nature of some pieces of control equipment made unattended operation risky, and it was usual to have personnel present at all times.

The MgO slurry for charging the reactor was made up in a separate tank and pumped directly to the bottom of the reactor vessels, again using screw type pumps.

As in the laboratory work, when it was required to remove carbonate from the influent acid (35% H₂SO₄) was added to the influent tank till the pH was around 5, while a continuous stream of air was passed through the liquor.

A filter press was provided for de-watering the residual solids, which were fed to the press from the solids holding tank (see Fig.3) using an air driven diaphragm pump.

FIG.3

PILOT PLANT FLOW SHEET

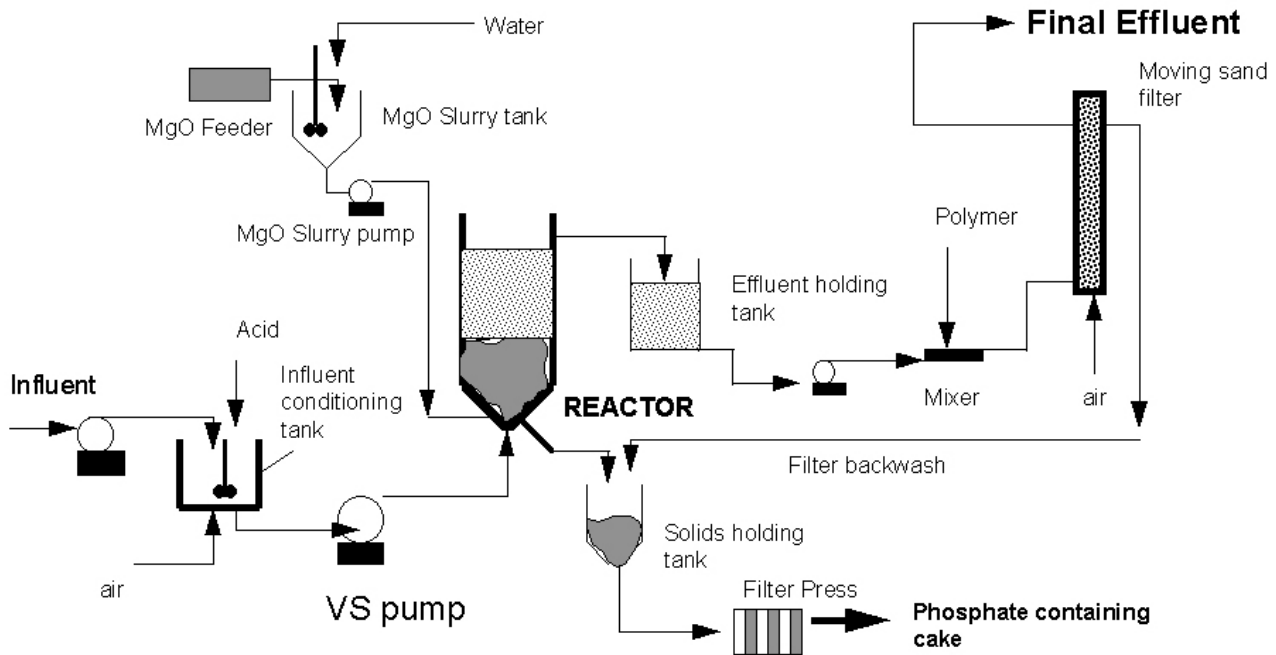

The pilot plant was constructed on two heavy steel frames, with all plumbing and electrical wiring well secured to professional construction standards. While the resulting plant was very photogenic and "Public Relations friendly", the robust nature of the construction detracted from ease of configurational changes and repairs, and consequently detracted from its utility as a true experimental test facility. Nevertheless the plant was used to conduct a series of trials at two of Sydney's sewage treatment plants (STP's) - Warriewood and St Mary's, the results and data from which were used in an economic evaluation of the process. The results from the Warriewood trials are discussed below.

2. TRIAL RESULTS

A number of extended trials of the pilot plant were conducted at Warriewood STP which is a secondary treatment plant located in the Northern Sydney suburbs. It discharges directly to the ocean, and is optimised for BOD removal and consequently is not required meet licence conditions for phosphorus or nitrogen. The effluent from this plant typically contains 5 - 9 mg.L⁻¹ phosphorus and 40 mg.L⁻¹ ammonia nitrogen, and also contains high bicarbonate alkalinity as well as some low molecular weight carboxylic acids resulting from fermentation of biological material in the sewage system. This STP effluent was used as influent to the pilot facility.

The results from two representative trials will be discussed here, and compared with those obtained from analogous laboratory tests described above. The major difference between the two trials was that the first was performed with high carbonate influent obtained directly from the STP, while in the second this was de-carbonated prior to introduction to the phosphorus removal reactors.

The operating conditions and major results are summarised in Table 4 below.

Since the present conference is primarily concerned with the recovery of phosphorus in the form of reusable products or feed stocks, details of the process performance in respect of the efficiency of phosphate removal from the sewage will not be discussed in detail here. Instead this discussion will concentrate on those aspects of the pilot plant Trials relating to the technical and economic viability of the process, and to the composition of the residual solids.

However, a brief description of the phosphorus removal profiles and other aspects of the process performance are discussed briefly in the Appendix.

As anticipated from the laboratory work the phosphorus removal from the sewage effluent was excellent (see Appendix) and demonstrated the capacity of the process in reducing the effluent phosphate to very low levels. However, other aspects of the trials were significantly different from those encountered during the laboratory work, and at this stage the reasons for the differences are not completely understood, and indicate that further development and investigative work - possibly on a less ambitious scale - is

required. In particular, it is felt that better knowledge and appreciation of the fluid and particle dynamics within the reactor vessels would be desirable.

Comparison of the data in Table 4 with that of Table 3 shows that while the consumption of MgO was similar for Trial 1 and Test 1 which were conducted with influent containing high bicarbonate, the consumption rate for Trial 2 was very much higher than for the corresponding laboratory Test 2. This is partly due to differences in the chemical composition of the

respective influents, and specifically the very high bicarbonate concentration in the STP effluent (ie 255 mg.L⁻¹), as well as to the unforeseen presence of propionic acid which was determined to be between 100 and 200 mg.L⁻¹.

The high usage of MgO is reflected in the high concentrations of dissolved Mg²⁺ in the pilot plant effluent compared with the concentrations in the corresponding laboratory tests.

Although these acidic species (ie ammonium, bicarbonate and propionic acid) are responsible for significant MgO consumption, there are other factors operating which are not understood at this stage. For example, it could have been anticipated that since the carbonate had been removed from the influent

TABLE 4

INFLUENT PARAMETERS and OPERATING CONDITIONS

Both tests conducted at flow of 2 m³/hr which corresponds to a reactor superficial velocity of 2.55 metre/hour.

Trial 1 ran continuously over a period of 88 hours, with 4 kg of fresh MgO (as slurry) added approximately every four hours.

Trial 2 ran continuously over a period of 77 hours, with 4 kg of fresh MgO (as slurry) added approximately every four hours.

For Trial 1 MgO consumption was 195 mg.L⁻¹.

For Trial 2 MgO consumption was 253 mg.L⁻¹.

	mean P in influent	mean HCO ₃ ⁻ in influent	mean NH ₄ ⁺ in influent	mean Ca ²⁺ in influent (as CaCl ₂)	<u>influent HCO₃⁻</u> <u>influent P</u>
TRIAL 1	5.1 mg.L ⁻¹	255 mg.L ⁻¹	39.5 mg.L ⁻¹	116 mg.L ⁻¹	~ 50
TRIAL 2	6.7 mg.L ⁻¹	approx. 0 mg.L ⁻¹	39.3 mg.L ⁻¹	117 mg.L ⁻¹	~ 50

EFFLUENT PARAMETERS

pH of reactor effluent always between 10.0 and 10.5

	mean P in effluent	HCO ₃ ⁻ effluent	mean NH ₄ ⁺ in effluent	mean Ca ²⁺ in effluent	mean Mg ²⁺ in effluent	% MgO USED IN REACTION
TEST 1	0.14 mg.L ⁻¹	ND (see text)	35.0 mg.L ⁻¹	18 mg.L ⁻¹	113 mg.L ⁻¹	60.2
TEST 2	0.4 mg.L ⁻¹	ND (see text)	34.0 mg.L ⁻¹	71 mg.L ⁻¹	137 mg.L ⁻¹	28.2

PARAMETERS FOR REACTOR SOLIDS

	% Ca ₃ (PO ₄) ₂	% CaCO ₃	% Mg(OH) ₂	% H ₂ O	wt. CO ₃ in solid
					wt. P in solid
TRIAL 1	6.4 (1.3% P)	48.8	27.5	8.3	22
TRIAL 2	7.2 (1.5% P)	8.3	72.3	22.9	3.5

in Trial 2, that the MgO consumption would have been reduced (by around 80 mg MgO per litre), but the opposite was in fact observed. It is considered significant that in trials such as Trial 2 a good deal of the MgO was not utilised in any "useful" reaction, but became converted to Mg(OH)₂, and this is evident from the analysis of the reactor solids - see further below.

The reasons for the differences are not entirely clear, but the explanation may, at least in part be connected with the manner in which the influent is distributed into the reactor. Due to simple geometrical factors it was not possible to provide the large pilot plant reactors with an influent distribution system identical with that in the laboratory equipment, and consequently the liquid flow patterns and other hydrodynamic factors (eg shear forces around the MgO particles) were different between the two sets of equipment. It is felt that this may have led to an increase in the rate of conversion of MgO to Mg(OH)₂ which is relatively inert under the operating conditions of this process. At the present, there are only indications that such factors are important, and in order to substantiate them and/or determine other factors which impact on the rate of MgO utilisation will require further study. Unfortunately it was possible or practicable to undertake these investigations during the course of the present pilot plant work.

Since the MgO is the most expensive consumable used in the process (approximately A\$600/tonne), it is important to optimise plant design so as to minimise usage of this reagent. Since good engineering practice should always follow the principle of "form following function", a good appreciation of these issues is mandatory in the design of process equipment.

It was remarked above that excessive calcite deposition was not apparent during the laboratory tests, and was consequently not anticipated prior to the pilot plant trials. However, calcite formation occurred throughout the pilot system - even during those trials such as Trial 2 where carbonate had been removed from the influent. In the latter case absorption of CO₂ by the alkaline effluent from the air used to drive the sand lift in the Dynasand filter was the source of the required carbonate.

The calcite formation caused operational problems at first, since under quiescent conditions after the system had been closed down it caused scaling in pumps and pipe work. Significant damage to pumps and other equipment resulted when the system was restarted. Once the problem was recognised and appreciated it was successfully controlled by flushing the system with water prior to shut down.

More significantly, large quantities of solid calcite particles were removed from the effluent stream by the sand filter (up to 200 mg.L⁻¹) and returned, via the filter backwash stream to the residual solids holding tank. This resulted in high calcite content and a reduced phosphorus grade in the final solid product. In respect of this point, the carbonate/phosphorus ratio in the product from Trial 1 was 22, which was significantly higher than the value of 1.9 found in the analogous laboratory test. - see Table 3.

The reasons for the high calcite deposition in the pilot plant as opposed to the laboratory work are thought to be primarily attributable to the agitated environment within the Dynasand filter. As remarked above, transfer of CO₂ from the air bubbles rising through the sand bed, and its absorption into the alkaline process liquor appears to drive the precipitation of calcite. However, while this is an important source of calcite in the residual solids, analysis of dissolved Ca²⁺ profiles through the process indicates a significant quantity of calcite (perhaps 30-50%) is deposited directly in the reactor. This is illustrated by the calcium profile for Trial 1 which is discussed in the Appendix.

The solids recovered from the reactors from both trial regimes are lower in phosphorus when compared with the products from the analogous laboratory tests by a factor of 4 - 5. In the case of the products resulting from de-carbonated influent such as Trial 2 the low P grade is due to the high Mg(OH)₂ component which implies that a high proportion of the original MgO was not effectively utilised during the course of the run. For the materials resulting from influent containing carbonate the low P grade is due to high calcite component, although inefficient use of the MgO as for Trial 2 also contributes.

Critical consideration of all the derived data indicates that removal of HCO₃ from the influent is not desirable, since the overall utilisation of the MgO was higher when bicarbonate was left in the influent. Although this led to high calcite in the residual solids, a high proportion of this resulted from return of the filter backwash to the solids, and this could easily be avoided through separate sedimentation of the backwash. In cases where it is necessary to supplement the influent with Ca²⁺ such a step would enable maintenance of a "calcium loop" in the system. The calcite could be easily converted to CaSO₄ or CaCl₂ for re introduction to the influent.

Unfortunately this strategy was not trialed during this campaign due to time constraints and the work required for the necessary changes in plant configuration.

To conclude this discussion, there was one other interesting difference between the data derived from laboratory studies and that from the pilot campaign, which has a bearing on the mechanism of calcium phosphate deposition.

It was mentioned above that in the laboratory studies that the solubility product for the amorphous calcium phosphate was invariably determined as around 10^{-23.5} ± 0.5 mole⁵litre⁻⁵-

ie $K_{sp} = [Ca^{2+}]^3 \cdot [PO_4^{3-}]^2 = 10^{-23.5 \pm 0.5}$ mole⁵litre⁻⁵

This quantity was routinely calculated throughout the experimental runs from analysis of the dissolved phosphate, calcium and pH of the filtered (through 0.45 micron membrane) reactor effluent, and appeared to be a very reliable operational parameter regardless of the chemical composition of the reactor influent. However, when similar calculations were performed using analysis of the filtered reactor effluent from the pilot plant trials, some different results were obtained. Specifically, when the influent had been de-carbonated, as for Trial 2 and similar trials, the calculated K_{sp} values (around 20 separate determinations from three different trials) were the same as those above - ie $10^{-23.5 \pm 0.5}$ mole⁵litre⁻⁵. However, for trials such as Trial 1 where the influent contained significant concentrations of bicarbonate, and where relatively large quantities of calcite were consequently deposited in the reaction bed, much smaller values for K_{sp} were obtained (around 16 determinations from three trials) which were typically around $10^{-25.2 \pm 0.35}$ mole⁵litre⁻⁵. This is a significant difference and indicates that under conditions of high carbonate that calcium phosphate is around two orders of magnitude less soluble than in carbonate free systems.

Such behaviour has been studied previously in relation to phosphate removal from natural lake and stream waters (eg. see references 5 and 6), and has been explained in terms of co-precipitation of calcium phosphate with calcite - the latter always in considerable excess. The mechanism whereby the solubility of the calcium phosphate is lowered in the presence of calcite appears to depend on the theory of solid solutions and will not be discussed further here, but McBride (ref. 7) gives a good introduction to this phenomenon.

It is important to note that, even when the influent to the laboratory equipment contained considerable carbonate, very little calcite deposited in the reaction beds - see discussion above -, and in these experiments the operational K_{sp} was always found to have the "standard" value of $10^{-23.5 \pm 0.5}$ mole⁵litre⁻⁵. It is only when calcite is present in the reaction bed in considerable quantity that the suppression of calcium phosphate becomes apparent.

While co-precipitation provides a good explanation for the lower K_{sp} of the calcium phosphate, it is difficult to see how such a mechanism would allow for increased utilisation of the MgO. However, as pointed out previously, there is little doubt that the utilisation of the magnesium oxide was significantly higher when carbonate was left in the influent stream and calcite was deposited into the reactor along with the calcium phosphate. There is other evidence that this is a real effect, and independent work by German workers has arrived at similar conclusions (D. Donnaert, private communication).

It is apparent that there is yet much to be learnt about the fundamental physical and chemical processes taking place during the important reactions, but this will require a good deal of further study. However, since an understanding of these factors is likely to impact significantly on optimisation of the process, the resulting economic benefits of such work may well justify the efforts.

CONCLUSIONS

1. TRIAL OUTCOMES

The pilot process demonstrated that phosphate could be effectively removed from sewage and that this was recoverable into a low grade (ca. 2%) phosphorus containing product. However, in treating sewage it was found that although removal of the bicarbonate (ubiquitous in such streams) should have enhanced utilisation of the magnesium oxide, (the primary reagent used in the process), the opposite was observed.

This is contrary to experience from laboratory tests, and the reasons for the differences are not entirely clear, although the manner in which influent is introduced into the reactor containing the MgO reagent may be important, but further work is required to clarify this.

However, the presence of calcite with the reactive magnesium oxide lowers the intrinsic solubility of the calcium phosphate through mechanisms involving coprecipitation, and may also have positive effects on the utilisation rate of the MgO.

In treating sewage at Warriewood under the two regimes discussed, the indicative operating costs for process implementation derived from the data above are -

As Trial 1 (no carbonate removal) - cost approximately A\$ 200 per megalitre,

As Trial 2 (with carbonate removal) - cost approximately A\$ 300 per megalitre.

Factors included in deriving these cost estimates include reagent, labour, plant maintenance and electric power costs, but the major cost component is that for the MgO (A\$600 per tonne).

These figures are both well in excess of the costs attracted by the current practice for phosphate removal from sewage effluent (which usually involves addition of ferric salts to the sewage, and assimilation of the insoluble ferric phosphate into the waste sludge), and which are closer to A\$ 100 per megalitre.

However, since no appropriate market analysis data was available, no allowance for potential sales revenue of the solid products was factored into these cost calculations, but if it is found possible to produce a higher grade phosphate product which could be

sold at a reasonable price, then the economics would be more favourable. Optimisation of MgO usage would also have a major impact on the overall process economics.

2. FUTURE DEVELOPMENTS

A process such as that developed during this work may not be entirely appropriate for the removal of phosphorus directly from sewage streams in an economically realistic manner because the relatively low P content (typically 7 - 10 mg.L⁻¹) and large volumes of these streams dictate large plant and capital outlay. Further, the operating costs are likely to be significant, although the revenue generated from sale of the recovered phosphate products could offset these costs. However, the process may be more economically attractive when applied to small or medium volume waste streams containing high phosphorus concentrations such as dairy processing plant effluent, supernatant from sewage sludge digestion (eg the Phostrip process), or effluent derived from animal wastes generated during high intensity livestock husbandry.

Nevertheless, before any full implementation is undertaken it would be desirable to have better understanding of the chemical and physical processes operative during the precipitation of the amorphous Ca₃(PO₄)₂.

These include - **1.** a better understanding of the hydrodynamics within the reaction bed, with particular reference to flow patterns, and shear forces etc around the MgO particles and the associated "calyx" of deposited calcium phosphate, and

2. An appreciation of the role of co-deposited calcite with reference to the role of this material in depressing the solubility of calcium phosphate through formation of solid solutions. The possible enhancement of MgO utilisation resulting from the presence of calcite should also be explored further.

It is also necessary to undertake a comprehensive analysis of potential

markets and remunerative values for the phosphate products.

ACKNOWLEDGEMENTS

The work described here is a brief summary of a great deal of data collected

during two and a half years of intensive laboratory and pilot plant work.

Most of the laboratory data was generated with the excellent assistance of

Mr. Bruce Willis and Ms. Doina Gudas, while Doina Gudas, Shoena Ye and

Amad Mtashar were together primarily responsible for conducting the pilot plant trials and generating the relevant data. The three latter personnel made unique and valuable contributions to the pilot plant campaign, despite the severe shortcomings of the plant and associated equipment. Their collective assistance is sincerely acknowledged, and this report could not have been prepared without their efforts.

APPENDIX

1. GENERAL PERFORMANCE

This appendix is a brief discussion on the removal of phosphorus from the sewage effluent, together with some remarks on other aspects of process performance .

The results for Trial 1 only are discussed, since these are fairly representative of the results obtained generally.

FIG. A1

TRIAL 1 - PHOSPHORUS PROFILE

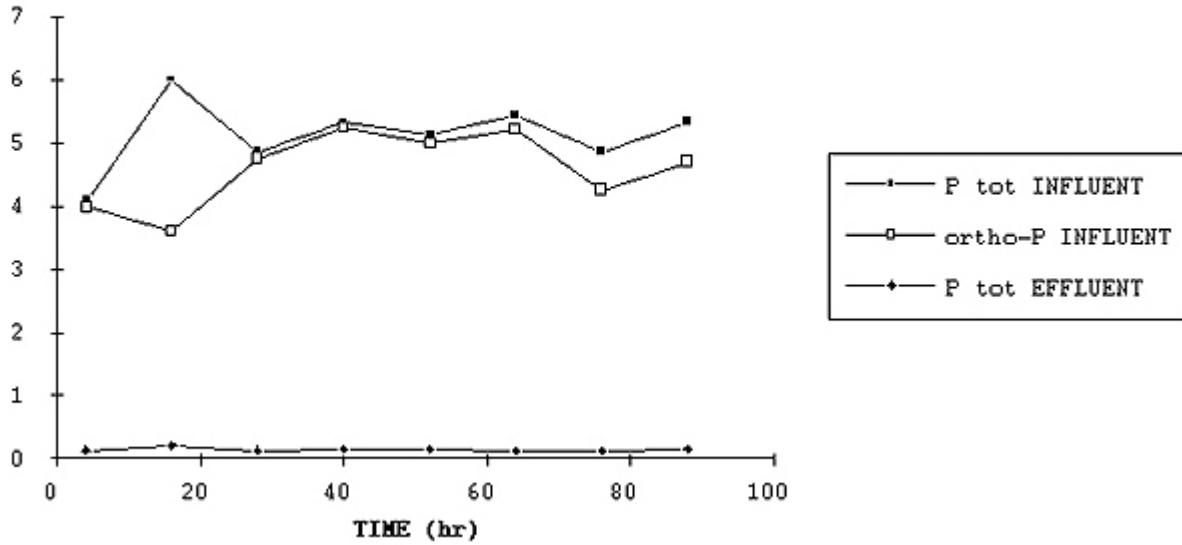

FIG A1 shows the time profile for total phosphorus removal. It is to be noted that while over 90% of the phosphorus in the STP effluent is in the form of dissolved ortho-phosphate, the remainder is primarily organic in nature. Nevertheless most of this organic component is also removed - probably through conversion by hydrolysis of the organic phosphate to soluble ortho-phosphate hydrolysis under the ambient high pH conditions. Alternatively, the organic material may be adsorbed onto the MgO since this material and magnesium hydroxide are well known to be effective adsorbent for colloidal organic material - see reference 8, and references therein.

The profile for total phosphorus and ortho-phosphate in the plant effluent (ie from the Dynasand filter) are reproduced in FIG A2.

It was noted that residual BOD and silica in the STP effluent were also substantially reduced after having passed through the MgO reactor, and the data is given in FIG A3. The reduction in BOD is almost certainly attributable to the adsorption of colloidal organic material (eg fats) to the MgO.

FIG A2

TRIAL 1 TOTAL EFFLUENT PHOSPHORUS vs EFFLUENT ORTHO PHOSPHATE

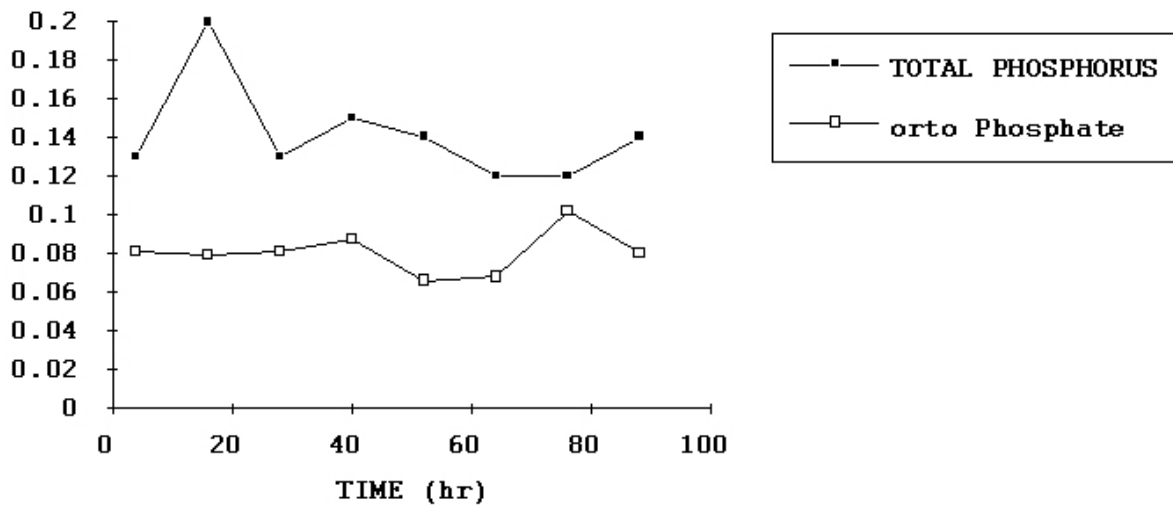
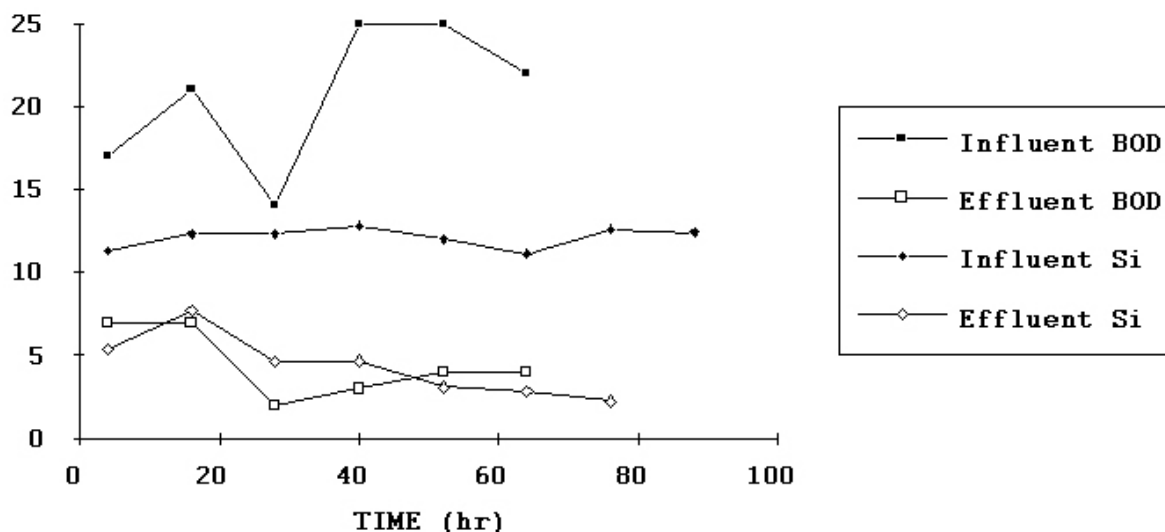

FIG A3

TRIAL 1 - BOD and Si PROFILES



As was remarked in the main text, for those trials (such as Trial 1) where carbonate was not removed from the influent, a good deal of calcite was deposited directly onto the reaction bed. This was obvious from consideration of the Ca^{2+} profiles through the process. For Trial 1 these are reproduced in FIG A4, where it is clear that there is a dramatic difference in the concentration of dissolved Ca^{2+} between the influent to the reactor and the reactor effluent (ie that held in the holding tank prior to being pumped to the filter - see FIG. 3). This can only be accounted for by significant CaCO_3 deposition within the reactor.

FIG A4

TRIAL 1 - CALCIUM PROFILE

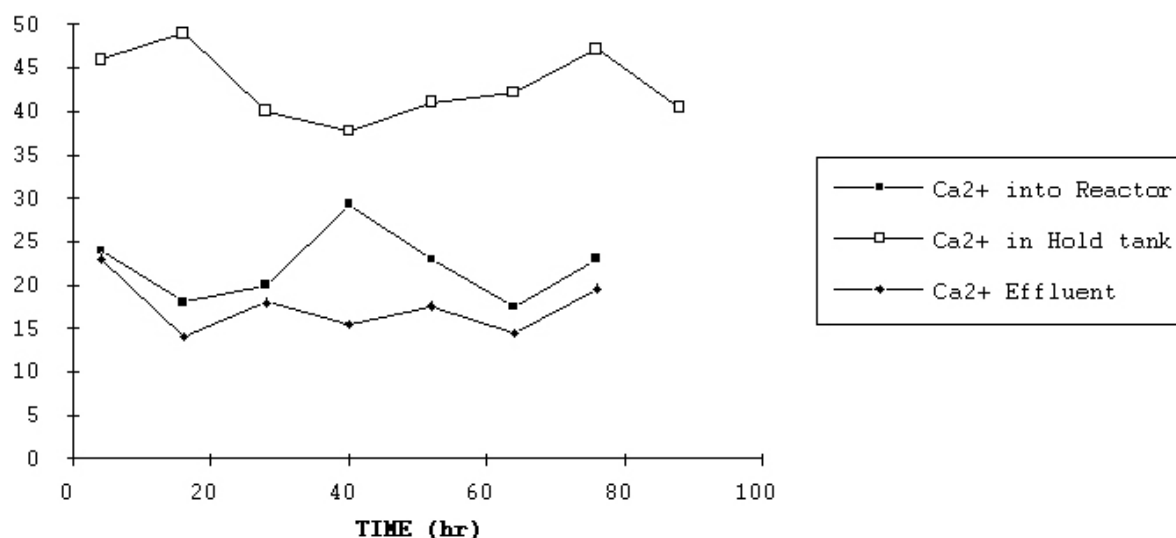

2. DEPOSITION OF STRUVITE ?

Since the STP effluent contained a high concentration of ammonium ion (around 40 mg.L⁻¹) in addition to the phosphate, and since this was passed through a high pH environment also rich in Mg^{2+} , the possibility of simultaneous removal of NH_4^+ and PO_4^{3-} as insoluble magnesium ammonium phosphate (ie MgNH_4PO_4 , the mineral struvite) could not be ignored. However, calculations based on the methods outlined by Stumm and Morgan (ref.2) indicated that under the prevailing conditions while it was possible that the solubility product of this compound (which is 10-12.6 mole³litre⁻³) could be slightly exceeded (by a maximum factor of 4), this was far outweighed by the tendency for deposition of the amorphous $\text{Ca}_3(\text{PO}_4)_2$. This would remove the phosphate, reducing any tendency for struvite formation. Further, analysis of the effluent indicated that while some ammonia had been removed as a consequence of passing through the process, this amounted to only around 3 mg.L⁻¹, and this was most likely lost to the atmosphere as ammonia gas - probably in the air stream discharged from the moving sand filter.

REFERENCES

1. H.Roques, L.Nugroho-Jeudy and A.Lebugle, "Phosphate Removal From Wastewater by Half Burnt Dolomite", *Wat. Res.* **25**, 959-965, 1991.
2. W.Stumm and J.J.Morgan, "Aquatic Chemistry - 2'nd edition", Wiley Interscience, 1981.
3. J.F.Ferguson and P.L.McCarty, "Effects of Carbonate and Magnesium on Calcium Phosphate Precipitation" *Env. Sci. and Tech.* **5** (6), 534, 1971.
4. S.Brett, J.Guy, G.K.Morse and J.N. Lester, "Phosphorus Removal and Recovery Technologies", Centre Europeen D'Etudes des Polyphosphates, Selper Publications, 1997.
5. W.A.House, "The Prediction of Phosphate Coprecipitation with Calcite in Freshwaters", *Wat.Res* **24**(8), 1017, 1990.
6. J. leiner, " Coprecipitation of Phosphate with Calcite in Lake Water" *Wat.Res.* 22(10), 1259, 1988.
7. M.B. McBride, "Environmental Chemistry of Soils", Oxford University Press, 1994.
8. G.M.Ayoub, S.I.Lee, C.N.Mazidgi, I.S.Seo, H.M.Cho and B.Koopman, "Seawater Flocculation of Emulsified Oil and Alkaline Wastewaters", *Wat.Res.* **26**(6), 817, 1992.

ELIMINATION OF PHOSPHORUS FROM WASTE WATER

BY CRYSTALLISATION

Dietfried Donnert, Manfred Salecker*

* Karlsruhe Research Centre, Institute of Technical Chemistry, Section Water- and Geotechnology,

P.O. Box 3640, D-76021 Karlsruhe, Germany

Abstract

By the application of the precipitation process using Fe and Al salts or lime, which is the main process used in Germany for phosphorus removal, some problems occur, such as an increase of the anion concentration of the water and problems to recover the phosphorus from the precipitation sludge. Therefore a process for phosphorus removal from waste waters was developed by a direct precipitation of Calcium phosphate induced by Calcite as seeding material. The adjusting of the pH was done with lime, but some experiments were done with MgO as well.

Basic investigations led to possible applications on both, municipal waste waters with low phosphorus concentrations and industrial waste waters with considerably higher phosphorus contents up to 400 mg/L P. Continuous bench scale experiments using a stirred reactor to remove phosphorus from the waste water of a motorcar factory have been completed. Based on the good results, a full scale device for the treatment of 160 m³ per hour was put into operation in July 1996 and has successfully run since this time. Furthermore, aspects for the recycling of the phosphorus are given.

1. Introduction

Phosphorus removal in Germany is usually effected by simultaneous and post-precipitation using Fe and Al salts or lime, respectively [1, 2]. But, these precipitation processes have some disadvantages, especially because the anion concentration of the water, i.e. chloride or sulphate, is increased and a recovery of the phosphorus is nearly impossible. In some places enhanced phosphorus removal, which avoids the main disadvantages mentioned above, is applied. Whenever this process is successfully running as in Berlin [3] it is a very suitable process. But, it is not running properly on all places. Therefore, research work on phosphorus removal has been carried out with the aim of avoiding the disadvantages of the precipitation process by developing a process for direct precipitation (crystallisation) of Calcium phosphate from waste waters induced by seeding crystals [4].

2. Physical-Chemical Fundamentals of the Calcite Crystallisation Process

The general idea of the Calcite crystallisation process [4] is as follows:

Domestic and industrial waste waters are usually supersaturated with respect to the very low solubility of most of the Calcium phosphate compounds. If the water is in equilibrium with hydroxyl apatite, the phosphorus concentration in the water should be » 0.002 mg/L P. However, despite much higher concentrations and this low solubility no precipitation occurs in real waste waters. Therefore, it was the basic idea of several developments in different countries, especially in Japan and in the Netherlands, to initiate this precipitation by means of seeding crystals [5, 6].

3. Previous Investigations

The first idea was the addition of Calcium-phosphate compounds and an adjustment of the pH ³ 9.0 to obtain the optimum chemical conditions for the precipitation, because in this pH-range the PO₄³⁻ ion becomes the predominant phosphorus species which favours the precipitation. Unfortunately, it turns out in all cases [5, 6], that the process is strongly retarded by the hydrogen carbonate which is present in every natural water system. As a consequence, the hydrogen carbonate ions have to be removed prior to the phosphate precipitation by acidifying to about pH = 4, blowing out the carbonate and afterwards by raising pH for the phosphate removal. Of course this is a considerable drawback for the crystallisation process. The acidification causes an increase of the sulphate concentration of the water, whereas the application of NaOH is expensive. And, furthermore it was shown (table 1) that a multiple use of the hydroxyl apatite resulted in a considerable deterioration of the phosphorus removal efficiency.

4. The Calcite Process (adjusting the pH with lime)

It was, therefore, the aim of the research work in the Karlsruhe Research Centre to avoid both, the pre-acidification and the use of NaOH. This was achieved by selecting Calcite (CaCO₃) as seeding material and using lime to adjust the pH [7].

1. Basic Experiments

Figure 1 shows the efficiency of phosphate elimination as a function of the pH. No technique for carbonate removal was necessary. The experiments show, too, that the phosphorus inflow concentration has no marked influence on the effluent concentration. This was also valid in the case of the starch water with an inflow concentration of about 120 mg/L P, which is cut off in figure 1.

Therefore the investigations, which were carried out in the beginning mainly on the treatment of secondary effluents, were focused towards industrial waste waters with higher phosphorus concentrations.

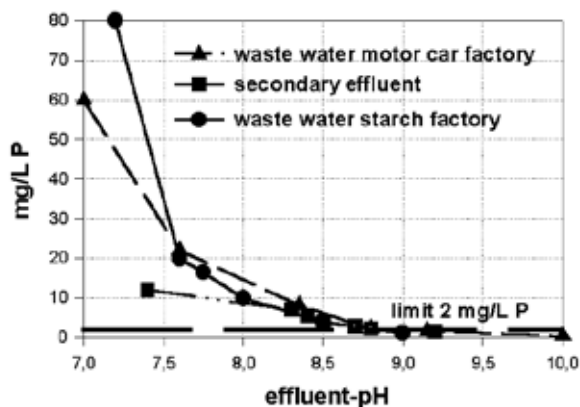

Figure 1:

Influence of pH on the efficiency of phosphorus removal by "crystallisation"

Further experiments were carried out reusing the seeding material several times because within a certain time of reaction, the surface of the material becomes covered with the precipitated Calcium phosphate, therefore, completely different conditions regarding phosphorus precipitation may appear. For this reason, experiments with secondary sewage effluent were carried out at pH ~ 9.0 [7,8], which showed as listed in table 1 that the phosphorus elimination is improved by a multiple (three time) reuse of the Calcite, and that simultaneously the amount of the Calcium carbonate precipitated is lower. From these results it was assumed that during the multiple use of the Calcite caused by the deposition of Calcium phosphate on its surface the precipitation of Calcium carbonate is inhibited.

On the other hand, a multiple use of hydroxyl apatite crystals caused a considerable deterioration of the phosphorus removal efficiency as already mentioned in section 3. Probably the carbonate layer formed on this surface has another mechanism, but no further attempt was made to investigate

Table 1

Results with Multiple Use of Calcite and HAP Seeding Crystals

HAP = Hydroxyl Apatite

Experimental conditions:

secondary effluent, c(P) in = 8,0 mg/L, c(Ca) in = 42 mg/L

10 g/L Calcite or 1 g/L HAP as seed, residence time 30 minutes,

pH = 9,0 adjusted with lime water (0,15 %),

Calcite reused	0	1	2	3
c(P) out [mg / L P]	2,7	2,0	1,6	1,6
P-Elimination [%]	66,0	74,2	79,7	79,7
D Ca/D P	12,4	6,8	3,8	2,4
c(Ca) [mg / L]	102	89	78	75
D Ca _{Calcite} ¹⁾	1,76	0,92	0,37	0,09
HAP reused	0	3		
c(P) out [mg / L]	1,2	6,2		

P]				
----	--	--	--	--

1. calculated by assuming a stoichiometric ratio Ca/P of 2.0 for the "crystallised"

Calcium phosphate

The results described above were further verified with throughput experiments [8], because the Calcite was only reused three times, which probably does not represent the stationary state. These first experiments for the treatment of secondary effluent gave promising results, with a concentration of 100 g/L Calcite (added in the beginning and never renewed) and a residence time of 30 minutes it was demonstrated in an experiment which lasted 40 days that the phosphorus concentration could be decreased from 8.2 mg/L P to 0.45 mg/L P depending on the pH-value (9.2 to 9.6) in the reactor. But at such high pH, a final neutralisation step would usually be necessary before the water may be released. This requires additional facilities and cost which, if the objective is simply to remove, rather than recover phosphate, can be avoided by the enhanced biological phosphorus removal in the case of domestic waste water [3].

1. **Long Term Experiments for Technical Applications**

Therefore, it seemed more interesting to test the process for the treatment of industrial waste waters with high phosphate concentrations. First, secondary effluent was adjusted to about 110 mg/L P by addition of sodium hydrogen phosphate solution. Already a pH of 7.3 yielded a phosphorus reduction of about 55 % to about 60 mg/L P. Therefore, continuous experiments were carried out with two industrial waste waters with a phosphorus content of ³ 100 mg/L P in order to extend the possible applications of this method. The results are shown in figure 1 [9].

1. **Experiments with the Waste Water of a Starch Factory**

Afterwards, further tests were carried out with waste water from a starch factory, which had been anaerobically pre-treated (³ 100 mg/L P, COD » 5.500 mg/L O₂). The experiments were performed in a scale of about 300 L/h and lasted three months. The aim was a partial phosphorus reduction to about 30 mg/L P, the average inflow concentration of the domestic sewage into the corresponding treatment plant which services the factory effluent. This aim could be easily fulfilled by adjusting the pH of the water to about 7.8 with lime, also, the sludge content of the water was very high (~ 650 g dry solids /mâ€ž). Furthermore, a reduction of about 15 % of the COD-content of the water was achieved. The results were are summarised in table 2 [10].

Table 2

Results of Continuous Experiments in a Starch Factory.

Inflow	158.9 ± 14.7 mg/L P
outflow	27.7 ± 2.7 mg/L P
effluent pH	7.8 ± 0.2

2. **Experiments with the Mixed Waste Water from the Mercedes Motorcar Factory in Gaggenau, Germany**

Other long term experiments were performed with a mixed waste water from the Mercedes motorcar factory in Gaggenau, Germany. Here, the goal was an effluent P-concentration of £ 2 mg/L P, the German effluent standard for direct release. To achieve this, the pH value of the water had to be increased to » 9.2. As a consequence, a neutralisation step was added which consisted of a precipitation by means of aluminium sulphate to pH = 7.5 followed by an Electroflotation unit, which was already applied in the old waste water treatment plant of the factory.

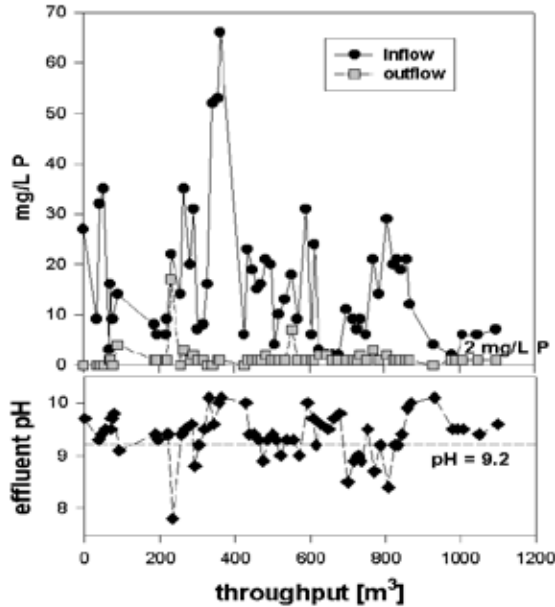

Figure 2:

Results of continuously running experiments for phosphorus removal from mixed waste water of the Mercedes motorcar factory Gaggenau, Germany. 100 g/L Calcite, detention time in the crystallisation unit: 20 minutes, throughput: 1m³/h.

The first experiments in the laboratory scale with very promising results are described in [9] . Additionally, continuous running experiments lasting for about 12 months were carried out in a stirred reactor with a throughput from 0.1 m³/h up to 1.1 m³/h corresponding to a retention time of 100 or 30 minutes, respectively [11]. 100 g Calcite per litre reactor volume were introduced at the beginning and lime was used to adjust pH. Again, the Calcite was never replaced or supplemented.

The mean values over a 12 month period are shown in table 3 . The phosphorus was removed very efficiently under the conditions described above. Usually the goal of £ 2 mg/l P was readily achieved in the outflow of the crystallisation unit, although the inflow concentrations rose to about 120 mg/l P in several cases and the water contained up to 300 g/m³ dry solids. On working days the pH of the inflow was adjusted to about 9.1, whereas at weekends it turned out to be necessary to raise the pH-value of the water to about 9.8. The reason for this was probably that machines in the factory were cleaned during the weekends with detergents containing organic crystallisation inhibitors. The neutralisation step effected a further reduction of the phosphorus content of the water to £ 1 mg/l P. Additionally, a further considerable COD-reduction of about 40 % was achieved.

The excellent results are further demonstrated in figure 2. It is obvious that the phosphorus outflow concentration of the crystallisation unit was almost invariably £ 2 mg/l P, although the feed concentration varied throughout the whole experimental period and the pH-adjustment was not very stable. In one case the pH of the water was as low as pH » 8.0, but the phosphorus concentration in the outflow was raised only slightly to about 3 mg/l P.

2. *Development of a Full Scale Device in the Mercedes Motor-Car Factory in Gaggenau, Germany*

The promising results described in the previous chapter lead to the development of a full scale plant for the treatment of 160 m³/h water [12]. The reasons were mainly, that most of the old equipment could be further used, only some amendments had to be installed and that it seemed possible to meet the effluent standard of £ 2 mg/L P just by pH-control regardless of the sludge content and the phosphorus concentration of the inflow.

The crystallisation step is carried out in the old precipitation device which has an improved stirring unit. The pH of the water is first adjusted with lime to 9.2 to 11 and fed into a stirred reactor with a volume of 18 m³ and with a residence time of 14 minutes. This reactor was filled at the beginning of the operation with a single charge of 1.6 tons of Calcite (grain size 0.35 - 0.7 mm) which has not been replaced to date (23 months). The water - solid - separation is performed in a parallel plate with a volume of 41 m³ followed by the neutralisation step with aluminium sulphate and an Electroflotation for the final removal of the solids in the water.

The operation of the full scale device started in June 1996. The results after one year of operation are listed in the following table 3 . In the meantime the composition of the waste water had changed: the difference between weekdays and weekend being no longer significant. In addition, the phosphorus concentration of the waste water was much lower which can also be followed by the

same table 3 . For this reason the phosphorus concentration in the sludge was also lower than in the earlier experiments. At the outflow of the crystalliser the phosphorus effluent standard of £ 2 mg/L P was met throughout the whole period and was further reduced in the final discharge after passing through the Electroflotation unit.

The X-Ray investigations in the sludge again gave no hint on the formation of crystalline compounds. Only after heating to 600°C was it possible to identify hydroxyl apatite - $\text{Ca}_5(\text{PO}_4)_3(\text{OH})$ and Magnesium Ammonium Phosphate - $\text{NH}_4\text{MgHP}_2\text{O}_7$ together with small amounts of Whitlockite $\text{Ca}_{18}\text{Mg}_2\text{H}_2(\text{PO}_4)_{14}$. This confirms the findings of earlier investigations [9-12], the phosphorus is mainly eliminated by amorphous precipitation.

Table 3
Waste Water Treatment Plant Mercedes Gaggenau, Germany
Results of the Preliminary Experiments and of the Full Scale Operation
from June 20, 1996 to June 17, 1997 (340 days)

	Concentrations in the Water			Sludge Analysis		
	mg/L Dry Solids	pH	[mg/L o-P]	After Drying at 100°C		
				[% P]	[%C] organic	[% C] inorganic
Studies in the Laboratory Scale with 0,1 m³/h						
Inflow	---	7,2 ± 0,1	40 ± 18	5,2	16,0± 4,0	-----
Outflow Crystallisation	---	9,6 ± 0,6	1,4 ± 0,9	10,0± 4,0	20,0± 5,0	----
Pilot Scale Studies with 1 m³/h						
Inflow	320± 400	7,3 ± 0,4	25 ± 17	5,0± 1,8	15,0± 4,0	0,8
Outflow Crystallisation	500± 450	9,4 ± 0,5	1,3 ± 1,0	8,5± 1,0	15,0± 3,0	2,0
Outflow Electroflotation	£ 0,5	7,6 ± 0,4	0,8 ± 0,8	£ 0,5 mg/L dry solids, no measurements		
Full Scale Operation July 1996 Å± July 1997 (80 m³/h)						
Inflow	640± 610	7,8 ± 0,6	11,6 ± 5,0	5,0± 1,3	24,1	0,3
Outflow Crystallisation	1,0± 3,0	9,3 ± 0,5	1,1 ± 0,8	6,0± 0,9	21,8± 3,8	3,0± 0,7
Outflow Electroflotation	£ 0,5	7,4 ± 0,4	0,3 ± 0,5	£ 0,5 mg/L dry solids, no measurements		

1. Experiments with Adjusting of the pH with MgO

In the experiments described above Calcite was used as the seeding material and $\text{Ca}(\text{OH})_2$ for the adjustment of the pH of the water. In Australia MgO, sometimes in a mixture with gypsum, serves as seeding material and pH-adjusting reagent in a fluidised bed system [13]. For this, pilot plant studies were carried out with municipal waste water [14] in the sewage treatment plant of Warriewood, NSW, Australia.

Based on this knowledge a joint research project was started in 1993 with the general goal of a further development of the existing German and Australian processes for phosphorus removal. Both systems employ seeding materials (i.e. Calcite and MgO), and the object of the project was to develop a "hybrid" process containing the best elements of both technologies [11, 13].

1. MgO-System (Australian System)

At the start of each experiment, the seeding crystal feed was set to 1 g MgO / L reactor volume in a fluidised bed system. Then the throughput of the water was started. The pH of the water rose to about 10.8 and the phosphorus concentration dropped to < 1 mg/L P (figure 3). After some time the phosphorus concentration rose to 2 mg/L P and the pH of the water dropped to about 9.8 corresponding to the exhaustion of the MgO. The efficiency of the process was determined by calculating this consumption of MgO as a function of the throughput.

2. Hybrid System (Karlsruhe Research Centre Development)

First powdered Calcite (50 g CaCO₃/L reactor volume) was added. Then the MgO was applied as described above.

3. *Composition of the Waste Waters*

In order to evaluate the "new" Australian System the experiments were carried out with "Australian" and "German" domestic waste water (table 4).

Table 4
Composition of the German and the
(Artificial) Australian Domestic Waste Water

	German Water	Effluent STP Warriewood (NSW, Australia)	Mercedes Water
	[mg/L]	[mg/L]	[mg/L]
Phosphorus	9-15	5	5-100
Ca	100-120	26	100-110
Mg	11-17	16	8-15
Na	22-29	177	n.d.
K	9-11	18	
Zn	0,2	0,1	
CO₃	120	132	
Cl	110	260	
SO₄	100	46	
NH₄	1-3	30	10-15

The "German waste water" was the secondary effluent of the sewage treatment plant of the Research Centre. The artificial Warriewood water (STP near Sydney, Australia) composed as listed in table 2 was used as an example of an Australian waste water. There is one significant difference between these two waters: the Australian water contains much less Calcium than the German one. This has to be taken into consideration, because the Ca-content is very important in the overall efficiency of the crystallisation process. There are also differences regarding the ammonia and sulphate content.

§ *Results of the Experiments*

In order to make an easy comparison possible two "efficiency factors F and F̄" were calculated from the results. F gives the ratio of the water throughput up to an effluent standard vs. the MgO used, which is the plot given in figure 3. This means, the higher the value the more favourable is the result.

F̄ gives the MgO consumption per m³ of treated water calculated from F.

2. *Results with Artificial Australian Waste Water "Warriewood"*

First of all the Australian method (MgO only) was applied to confirm the results reported in [13, 14], later hybrid experiments (CaCO₃ + MgO) were carried out.

The results of two series with four experiments each where MgO and the hybrid system was applied, are plotted in the following figure 3. Assuming an effluent limit of 2 mg/L P the efficiency F and F̄ based on the MgO consumption as described above amounted to

$$\text{MgO-System } F = 7.2 \pm 0.5 \text{ L / g MgO or } F̄ = 0.14 \text{ kg MgO / m}^3$$

$$\text{Hybrid system } F = 12.0 \pm 0.2 \text{ L / g MgO or } F̄ = 0.075 \text{ kg MgO / m}^3$$

Thus a remarkable improvement in the utilisation of the MgO occurred in the hybrid system in comparison with the MgO system. Probably the phosphorus crystallisation was improved by the Calcite, which served as additional nuclei. There

was no significant change in either the Ca-concentration or the Mg-concentration in the water: the slope was quite the same with and without Calcite, first a slight decrease, afterwards almost constant.

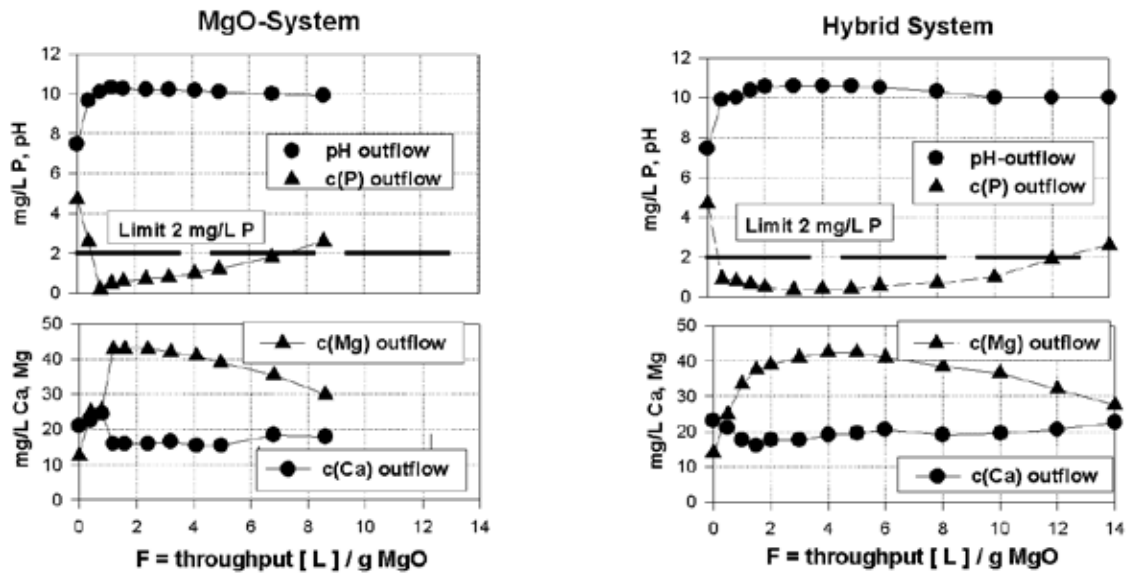

Figure 3:

Australian domestic waste water - Results with MgO-suspension and with the hybrid system (MgO + CaCO₃)

4. Experiments with German Domestic Waste Water

Additionally experiments with the German domestic waste water of the Research Centre Karlsruhe (table 5) were carried out. The Australian system (with and without addition of Ca²⁺-ions) was applied and finally again the hybrid system was investigated using Calcite and MgO.

Assuming an effluent limit of 2 mg/L P the efficiency F and \bar{F} based on the MgO consumption like described at the beginning of the section amounted to

$$\text{MgO-System } F = 7.5 \hat{\pm} 0.5 \text{ L / g MgO or } \bar{F} = 0.16 \text{ kg MgO / m}^3$$

$$\text{Hybrid system } F = 12.0 \hat{\pm} 0.2 \text{ L / g MgO or } \bar{F} = 0.08 \text{ kg MgO / m}^3$$

These results are remarkably similar to those obtained with Australian waste water. Once again, a significant improvement in efficiency occurred with the German water with the addition of Calcite when compared to the application of MgO alone. The improvement attained was similar to that obtained by a continuous addition of a CaCl₂-solution up to 200 mg/L Ca [8] in earlier experiments.

5. Discussion of the Results

The results show the great advantage using Calcite as a seeding material. This means, that the influence is the same whether lime or MgO is used. Regarding the practical application it has to be mentioned that the MgO process is carried out at a very high pH of ³ 11,0 which means that the neutralisation cost are much higher compared with the Calcite process which is carried out at pH » 9,2.

• Application of the Calcite Process for the Recycling of the Phosphorus

The crystallisation process has proved himself as a very effective tool for the removal of phosphorus particularly at higher concentration ranges of about 100 mg/L P. It is very easy to handle, because the effluent phosphorus concentration can be set by adjusting the pH with lime. Thus, on-line measurements can be simplified or even omitted.

In the special case of the Mercedes factory no special attention was given to the recycling aspect. The main reason was, that the sludge contained a great amount of organic carbon which derived from the oil components mainly.

1. Results of Recycling Experiments in the Laboratory Scale

Currently laboratory experiments are being carried out with special regard to the "crystallisation" product for the recycling of the phosphorus. The details of the device and the preliminary results up to now are listed in the following table 5 .

Table 5

Results of Recovery Experiments with the Calcite Process

Device : *Stirred* reactor (2 litres), sludge return 1,2 L/H

Calcite : 50 g /L reactor volume; 0,25 \bar{A} ± 0,4 mm particle size

pH adjusting : Lime suspension (2 %) or lime water (0,15 %)

Throughput : 2 L/h

Residence time : 60 minutes

Influent : Secondary effluent FZK STP, supplemented to 80 mg/L P

With Calcite (0,2 \bar{A} ± 0,4 mm)		without Calcite
Ca(OH)₂- Consumption for adjusting a pH - value		
pH = 9,54 ± 0,26	pH = 9,0 ± 0,3	pH = 9,86 ± 0,50
Using		
Lime suspension (2 %)	Lime water (0,15 %)	Lime suspension (2 %)
0,21 ± 0,04 g Ca(OH) ₂ / L	0,07 ± 0,03 g Ca(OH) ₂ / L	0,29 g ± 0,08 Ca(OH) ₂ / L
Carry Over		
57,9 ± 8,8 mg/L 14,3 % P	41,7 ± 5,1 mg/L 17,2 % P	63,4 ± 18,2mg/L 13,9 % P
Calcite		
1,6 % P	2,1 %*)	-----
Settled Sludge		
0,43 g/L 13,5 % P	*)12,4% P	0,31 g/L 13,1 % P

*) The corresponding experiments are still running, the value given is intermediate or in progress

According to the results listed above the Calcite causes a much more stable treatment, which can be recognised on the lower lime consumption as well as on the lower standard deviation. Additionally, the lime water seems much more favourable regarding the chemical consumption.

2. X-Ray Analysis of the Products

In the diagrams only after heating to 900°C crystalline Ca-P-compounds (different forms of apatite) were detected, which means, that the original products are amorphous as already stated earlier in the Mercedes experiments (section 4.3).

3. Discussion of the Results for Phosphorus Recycling

The Calcite process proved itself a more stable one, required less lime suspension for the pH adjusting than the "normal" lime precipitation and, at a pH of 9.5, yielded a sludge with 14 % P. Regarding recycling the application of lime water rather than lime suspension seems to be more favourable, because a sludge with about 18 % P was obtained (pH about 9,2) in the first experiments compared to 15 % P with lime. However, in this case the phosphorus was collected in the carry over instead on the Calcite material.

· Outlook, Planning of Further Experiments for Phosphorus Recycling

The Calcite process seems a promising method to enable a good recycling of the phosphorus. Further experiments are necessary especially with a Calcite with a larger grain size with shorter retention times. Successful laboratory tests need to be followed-up by larger scale field trials where the German - Australian hybrid process described in section 5.2 with MgO should also be employed.

For the following 1 - 1,5 years the following experiments seem promising and valid:

1. Comparison column (fluidised bed) - stirring reactor in the laboratory scale for about 3 months

with a feed of an artificial waste water of the Phostrip process containing about 70 mg/L P

whilst varying:

- the pH-value
- the grain size of the Calcite seed
- the residence time

2. Long term experiments in the laboratory scale for about 3 months with the same water as feed

with the goals:

- optimisation of the automatic control
- verification of the previous results

3. Design and construction of a pilot plant and running of pilot plant experiments in field situations.

1. References

- [1] Jedele, K., Bunkofer, A. et al.: Auslegung von Anlagen zur weitergehenden Phosphatelimination. Korrespondenz Abwasser 38 H.2 (1991), 170-183
- [2] Zacher, B.: Weitergehende Phosphorelimination durch Flockungsfiltration im Anschluß an die chemische Fällung. Stuttgarter Berichte zur Siedlungswasserwirtschaft 90 (1986), 67-95
- [3] Sarfert, F., Boll, R., Kayser, R., Peter, A.: Biologische Phosphorentfernung in den Klärwerken Berlin - Ruhleben und Berlin - Marienfelde. Gwf-Wasser/Abwasser 130 (1989) H.3, 121-130
- [4] Donnert, D. et. al.: Elimination von Phosphat aus Wasser durch impfkristallinduzierte Abscheidung von Calciumphosphat. GWF Special I, S51-S56 (1995)
- [5] Eggers, E. et al.: Full-scale Experiences with Phosphate Crystallisation in a Crystalactor. Wat. Sci. Techn. 23 (1986), 819-824
- [6] Sato, K. et al.: Final Report on the crystallisation process. ISSN 0836-5878 (March 1983) Public Works Research Institute, Ministry of Construction, Tsukuba Science City, Japan
- [7] Rieger, J.A., Donnert, D., Eberle, S.H.: Möglichkeiten der Phosphatelimination aus Abwasser durch Abscheidung von Calciumphosphat. Vom Wasser 71 (1988), 27-40
- [8] Donnert, D. Research work on Phosphorus Removal from Waste Water
Report Research Centre Karlsruhe KfK 4459 (October 1988), 4-33 (ISSN 0303-4003)
- [9] Donnert, D., Salecker, M., Müller, A., Eberle, S.H.: Abscheidung von Calciumphosphat aus Abwasser mit Hilfe von Calcit. Z. Entsorgungspraxis 12 (Dezember 1991), 793-799
- [10] Donnert, D., Salecker, M., Eberle, S.H.: Phosphatelimination aus Wasser durch impfkristallinduzierte Abscheidung von Calciumphosphat. Wasser Boden 5 (1993), 312-316.

[11] Donnert, D., Salecker, M.: Phosphorus Removal and Recovery from Waste Waters. Proceedings of the 3rd Australian-German Workshop, Dec. 13-16, 1994, 37-38

ISBN 0 642 244444 8

[12] Donnert, D., Gensicke, R., Merkel, K., Salecker, M., Eberle, S.H.: Elimination von Phosphat aus industriellem Mischabwasser durch impfkristallinduzierte Abscheidung von Calciumphosphat. Z. Abwasserforschung (in press).

[13] Brett, S., Guy, J., Morse, J.K., Lester, J.N.: Phosphorus Removal and Recovery Technologies, Selper Publications, ISBN 0 948411 10 0, 1997, 54-56

[14] Angel, R. AWT Sydney ± International Conference on Phosphorus Recovery from Sewage and Animal Waste, Warwick University, UK. May 5th & 7th, 1998. Organised by Centre Européen d'Études des Polyphosphates, Bruxelles, Belgium

Contents

1 Introduction *

2 Physical-Chemical Fundamentals of the Calcite Crystallisation Process *

3 Previous Investigations *

4 The Calcite Process (adjusting the pH with lime) *

4.1 Basic Experiments *

4.2 Long Term Experiments for Technical Applications *

4.2.1 Experiments with the Waste Water of a Starch Factory *

4.2.2 Experiments with the Mixed Waste Water from the Mercedes Motorcar Factory in Gaggenau, Germany *

4.3 Development of a Full Scale Device in the Mercedes Motor-Car Factory in Gaggenau, Germany *

5 Experiments with Adjusting of the pH with MgO *

5.1 MgO-System (Australian System) *

5.2 Hybrid System (Karlsruhe Research Centre Development) *

5.3 Composition of the Waste Waters *

5.4 Results of the Experiments *

5.4.1 Results with Artificial Australian Waste Water 'Warriewood' *

5.4.2 Experiments with German Domestic Waste Water *

5.4.3 Discussion of the Results *

6 Application of the Calcite Process for the Recycling of the Phosphorus *

6.1 Results of Recycling Experiments in the Laboratory Scale *

6.2 X-Ray Analysis of the Products *

6.3 Discussion of the Results for Phosphorus Recycling *

7 Outlook, Planning of Further Experiments for Phosphorus Recycling *

8 References *

BACKGROUND:

Nutrient removal from wastewater discharges is an increasing challenge for water authorities, as regulatory authorities tighten discharge standards to avoid eutrophication problems in receiving waters. Significant costs are associated with the extra treatment processes required to meet these new discharge standards. The most widely used technologies for nutrient removal include biological nitrification/denitrification for nitrogen removal and metal salt precipitation for phosphorus removal. Both approaches result in the nutrient being made unrecoverable as a fertiliser. An alternative to these conventional technologies which can provide for recovery of the nutrient as a commercial fertiliser could be the production of struvite.

Nitrogen and phosphorus are normally present in domestic sewage at concentrations of around 40 and 10 mg/l respectively. While very dilute, the enormous flows of sewage mean that significant quantities of N and P enter the natural environment each year via sewage flows. For example, the Melbourne Western treatment plant at Werribee processes about 600,000 m³/day of effluent, with a total phosphate flow of around 18 tonnes per day or nearly 6,600 tonnes per annum. At Australian market prices for super phosphate fertiliser, this phosphate discharge is theoretically worth ~ A\$4.9 million per annum! The fundamental problem with realising any value for this phosphorus is the difficulty of concentrating it out of a dilute solution into a sufficiently concentrated form where it can be marketed as a useful product. Assuming that some process can be devised for recovering and concentrating the nutrients in sewage into a useable form, what is the potential value of these nutrients and to what extent can they offset the cost of wastewater treatment? Assuming a value for anhydrous ammonia of A\$300 per tonne (82% N) and A\$500 per tonne for wet process phosphoric acid (75% PO₄) and concentrations of NH₃ and P in sewage of 40 and 10 mg/l respectively, then the value of the nutrients in a kilolitre of sewage is 3.5 cents. With wastewater treatment operating costs being around 10 c/kl, recovery of the nutrients as a fertiliser is obviously not a direct economic proposition. However, it could be a good way to offset some of the unavoidable costs associated with treating the wastewater before discharge and final disposal of the sludge.

CURRENT NUTRIENT REMOVAL TECHNOLOGIES

Current approaches to nutrient removal from sewage and other wastewaters are summarised in the following table.

	Nitrogen	Phosphorus	Advantages/Disadvantages
Biological Approaches	<ul style="list-style-type: none"> Biological nitrification and subsequent denitrification. 	<ul style="list-style-type: none"> Biological phosphorus removal (BPR) 	<ul style="list-style-type: none"> Nitrification/denitrification removes NH₃ from nutrient cycle; BPR stores PO₄³⁻ in cell structure - still available as a nutrient
Physicochemical Approaches	<ul style="list-style-type: none"> Adsorption on zeolites or ion exchange resins regeneration with caustic brine; Air stripping 	<ul style="list-style-type: none"> Precipitation with metal salts 	<ul style="list-style-type: none"> Absorption of ammonia allows recovery as a concentrate; Precipitation of PO₄³⁻ as the metal salt renders it unavailable as a fertiliser; Air stripping needs high air:water ratios and caustic demand

Biological phosphorus removal

Biological processes for the removal of phosphorus have been developed during the last twenty years and are now beginning to compete with the more conventional physico-chemical approach of precipitation with metal salts. Biological phosphorus removal (BPR) plants commonly involve a number of different stages of treatment, including anaerobic, aerobic and anoxic zones and require liquid residence times of around 24 hours. They are thus large plants with a significant capital and operating cost. On average and with good operational control, BPR plants can reduce phosphorus concentrations to less than 1 mg/l, although some plants with insufficient readily assimilable carbon in the feedwater have difficulty in consistently achieving this level.

The phosphorus in the raw sewage accumulates in the sludge as polyphosphate crystals, with P concentrations in the sludge being around 5g/l. If this sludge goes anaerobic at any stage, the phosphorus is released back into solution as orthophosphate and consequently most BPR plants avoid anaerobic digestion of the sludge before disposal. The undigested sludge is unstable and odorous but can be stabilised by aerobic digestion without incurring phosphorus release, although it is always possible for the

sludge to go anaerobic at a later stage during storage eg in a land-fill. Sludges from extended aeration plants should be at least partially stabilised. Another approach is to treat the sludge with lime to bind up the phosphorus as the insoluble calcium phosphate.

At those plants where the sludge is digested anaerobically, both ammonia and soluble orthophosphate appear in solution at concentrations between 500 and 1,000 mg/l. This solution is usually separated from the sludge during further processing, such as belt pressing, and must then be dealt with separately. In most cases, this involves lime addition to tie up the phosphorus and recycle of the ammonia rich liquors back to the inlet of the plant where the ammonia must be nitrified. However, the ammonia and phosphate in the sludge liquors could be used in the production of a solid fertiliser such as struvite.

Physico-chemical phosphorus removal

Phosphorus can also be removed by precipitation with metal salts such as aluminium, iron and calcium, with final P concentrations below 1 mg/l being achievable with this approach. To achieve lower phosphate concentrations, increasingly high doses of metal salts are required, often in excess of two times stoichiometry. Because of its relative simplicity and reliability, metal salt precipitation has been used more widely than BPR to remove phosphorus. However, the high chemical cost and significantly increased sludge volumes associated with metal salt precipitation are definite disadvantages and have led to the increasing use of BPR. Another disadvantage is that metal salt precipitation ties up the available phosphorus and thus makes it unavailable as a nutrient.

PHOSPHATE RECOVERY AS STRUVITE

In domestic sewage the molar ratio of nitrogen to phosphorus is around 8 to 1 with the phosphorus normally being present as the soluble orthophosphate. This molar imbalance and the relatively low concentration of phosphorus in sewage make the recovery of phosphorus in a useable form a significant challenge. A better source of phosphate for recovery as a fertiliser is the phosphate released into solution when the sludge from a BPR plant undergoes anaerobic digestion. In this case, phosphorus concentrations of around 500 mg/l can be reached in the supernatant solution.

As the orthophosphate ion is not volatile (unlike ammonia) and is of similar molecular size to other ions in sewage, the only viable approach to its recovery in a concentrated form is precipitation as an insoluble salt. This approach is, of course, the basis of the most widely used method for phosphate removal from wastewaters, namely precipitation as the metal salt eg FePO_4 . However, such salts completely tie up the phosphate thus making it unavailable as a nutrient. The range of salts called metal ammonium phosphates have the propitious properties of being not only insoluble enough to achieve significant phosphorus removal but also of being able to make the phosphorus and ammonia available to plants by a biologically based slow release mechanism (Bridger et al., 1962). The most well known example of this type of salt is "struvite" or MgNH_4PO_4 , which is commonly formed in anaerobic digesters when significant levels of Mg occur in the raw sewage. The excellent fertilising properties of struvite have been well studied and reported in a number of publications (Lunt et al., 1964). Salutsky et al. (1972) have clearly demonstrated the efficient precipitation of phosphorus from anaerobic digester effluents as MgNH_4PO_4 , with P levels being reduced from around 100 mg/l to 2-3 mg/l. Simultaneous ammonia removal was also achieved and elemental analysis found the precipitate to be largely struvite.

The recovery of both ammonia and phosphate from sewage and the subsequent production of struvite has been well studied by Liberti et al (1981). In this study, both ammonia and phosphate anions were recovered from secondary sewage effluent via ion exchange and the eluants from resin regeneration used to produce both magnesium ammonium phosphate (MgNH_4PO_4) and ammonium nitrate (NH_4NO_3). While an economic analysis of this nutrient recovery process appeared favourable, it was not adopted commercially, the main reasons appearing to be the high cost of chemical inputs (MgCl_2 , NaOH and brine solutions) and the failure to establish a firm market for the fertiliser produced.

Uses for struvite

Studies by Bridger et al. (1962) have confirmed the excellent agronomic properties of MgNH_4PO_4 . While only slightly soluble in water and soil solutions, struvite was found to be a highly effective source of phosphorus, nitrogen and magnesium for plants through both foliar and soil application. The release of nutrients appeared to be enhanced by a biological nitrification mechanism, with the nutrients being released at a controlled rate over an extended period of time. When properly granulated, it can be applied to soil at rates greatly exceeding those of conventional fertilisers without danger of burning plant roots.

Economics

Despite such attractive agronomic properties struvite is not widely used in the fertiliser industry, the main reason appearing to be its high cost of production from the raw chemicals. As described above, Liberti et al. (1991) had to use both MgCl_2 and NaOH in addition to ammonia and a phosphate source. Other studies (Schulze-Rettmer, 1991) have also highlighted the significant chemical cost associated with this approach.

In a wastewater treatment plant which is required to remove both nitrogen and phosphorus, the cost of supplying N and P is just the incremental cost associated with changing the treatment plant design as discussed in previous sections. The supernatant from the anaerobic digester of a BPR plant is an excellent source of both N and P for struvite production, but this still leaves the cost of both MgCl_2 and NaOH supply. However, a good understanding of the process chemistry, combined with clever design, has the potential to produce a cost effective process for struvite production.

References:

Bridger, G L, Salutsky, M L, Starostka, R W (1962) "Metal Ammonium Phosphates as Fertilisers", *Agricultural and Food Chemistry*, 10, 3, 181-188

Liberti, L, Gianfranco, B, Petruzzelli, D, Passino, R (1981) "Nutrient Removal and Recovery from Wastewater by Ion Exchange", *Water Research*, 15, 337-342

Lunt, O R, Kofranek, A M and Clark, S B (1964) "Availability of Minerals from Magnesium Ammonium Phosphate", *Agricultural and Food Chemistry*, 12, 6, 497-504

Schulze-Rettmer, R (1991) "The Simultaneous Chemical Precipitation of Ammonium and Phosphate in the Form of Magnesium Ammonium Phosphate", *Water Science & Technology*, 23, 659-667

Adapting Strategies for avoiding struvite build-up in plants and transforming them into strategies for recovery

Steve Williams
Thames Water Utilities Ltd.
Spencer House, Manor Farm Road, Reading, RG2 0JN.

Abstract

Phosphorus removal as part of wastewater treatment is becoming more widespread in the United Kingdom as the Urban Wastewater Treatment Directive is implemented. Phosphorus removal can be achieved by either chemical or biological means or by a combination of both methods. When the phosphorus is removed biologically the phosphorus stored in the waste sludge may be released during anaerobic digestion. As digested sludge contains a high concentration of ammoniacal nitrogen it is likely that struvite may be formed if the magnesium concentration is sufficiently high.

At Slough wastewater treatment plant struvite precipitation has been a problem for a number of years. A recent extension to the plant built as a 3-stage Bardenpho plant has reduced the phosphorus concentration in the effluent and lead to an increase in struvite precipitation in the digested sludge pipelines. These problems have been overcome in the short term by dissolving the struvite in 10% sulphuric acid. It is hoped to provide longer term protection against struvite precipitation by installing magnetic water softening devices at key locations. This form of protection is already providing some benefit at one point on the site.

The phosphorus concentration and loads at a number of points on the site has been investigated. By combining two streams, the centrate from the sludge dewatering plant and the liquor from thickening the waste activated sludge, a relatively clean stream containing 160 mg l^{-1} of soluble phosphate, a load of 136 kg d^{-1} . In order to make best use of this stream it is important to prevent struvite formation at other points in the plant where the precipitation can cause operational problems. If magnetic water softeners prove to be successful they will provide an important part of the phosphorus recovery from wastewaters.

Introduction

The need for nutrient removal as part of the wastewater treatment process in the United Kingdom has arisen from the Urban Waste Water Treatment Directive which was adopted by the EC on March 18, 1991⁽¹⁾. The Directive sets discharge limits for some of the established sanitary determinands e.g. BOD and suspended solids, and the nutrients nitrogen and phosphorus. The limits for nutrients are shown in Table 1 and are annual average values based on 24 hour composite samples.

Table 1. Limits for nitrogen and phosphorus as required by the Urban Waste Water Treatment Directive.

Parameter	Population 10,000 to 100,000	Population > 100,000	Minimum Reduction
Total Nitrogen *	15 mg l^{-1}	10 mg l^{-1}	70 % - 80 %
Total Phosphorus	2 mg l^{-1}	1 mg l^{-1}	80 %

*Alternatively the daily average total nitrogen concentration must not exceed 20 mg l^{-1} , and the standard only applies when the wastewater temperature is greater than 12°C .

These standards become effective on or before December 31, 1998 for wastewater treatment works which discharge to watercourses that are designated as "sensitive." The DoE has designated much of the non-tidal Thames and some tributaries as sensitive. This designation may require, in the future, phosphorus removal at as many as 65 wastewater treatment works.

Phosphorus removal can be achieved chemically by precipitating the phosphorus with a metal salt e.g. Iron II, Iron III, Aluminium and calcium. Biological removal requires the bacteria to be exposed to firstly anaerobic and then, secondly anaerobic conditions. This sequence helps to select groups of bacteria that are able to concentrate the phosphorus in their cells as poly- phosphate chains⁽²⁾. However when these bacteria are exposed to anaerobic conditions, as in an anaerobic digester, some of the phosphorus is released as soluble phosphate. In order to retain the phosphorus in the sludge it may be necessary to precipitate the phosphorus as a metal phosphate or as struvite.

Slough Wastewater Treatment Plant

Slough wastewater treatment plant is situated to the south of Slough town and is bordered on one side by the M4 motorway. The plant treats the wastewater from a domestic population of approximately 150,000 and an industrial population equivalent of 150,000. Until 1996 the wastewater was treated primarily by a two stage biological process following preliminary and primary

treatment. The settled wastewater was treated firstly in a non-nitrifying activated sludge plant which removed most of the biodegradable organic load and then in nitrifying trickling filters. The surplus activated sludge and the humus sludge were co-settled in the primary tanks with the incoming wastewater and the sludge produced was digested and dewatered in a centrifuge before being recycled to agricultural land as a soil conditioner. The centrate was returned to the inlet works for treatment.

Slough wastewater treatment plant has had a struvite problem for many years. The centrifugal pumps which return the centrate had to be removed and the struvite chipped from the pump casing every two weeks. This task was accomplished using a hammer and chisel and was extremely labour intensive. In an attempt to alleviate the problem a magnetic water softening device supplied by Scale Watcher was fitted to the pipework before the centrifuge. It was hoped that this would prevent the struvite from precipitating in the pump and reduce the manpower cost of operating the plant. At the time this solution did not appear to have any beneficial effect despite a number of attempts to overcome the problem.

In 1994 Thames Water agreed with the Environment Agency to treat a larger volume of wastewater before discharging to the storm overflow. This led to a doubling of the flow to full treatment and it was clear that the existing combination of activated sludge and trickling filter would not be able to meet the consent. During the design of the plant it was foreseen that the high concentration of soluble Chemical Oxygen Demand (COD) in the settled wastewater would give rise to a very high oxygen demand at the beginning of the activated sludge plant which would be difficult to meet⁽³⁾. Experience from other Thames Water treatment plants suggested it was likely that the resulting low levels of dissolved oxygen would lead to "bulking", i.e. poor settling sludge, and the plant would therefore be difficult to operate.

Although the consent for Slough does not require phosphorus removal it was decided to build the extension to the works as a biological nutrient removal plant. In this way the soluble COD would be utilised in the un-aerated parts of the plant before it reached the first aerobic section, so reducing the risk of bulking.

Biological Nutrient Removal Plant at Slough

The new extension at Slough is a three stage Bardenpho plant designed to treat the wastewater from a population equivalent of 165,000. The remaining flow is treated in part of the existing two-stage activated sludge, trickling filter plant. The overall plant is shown schematically in figure 1 and one aeration lane is shown in figure 2.

Figure 1. Schematic representation of Slough Wastewater Treatment Plant.

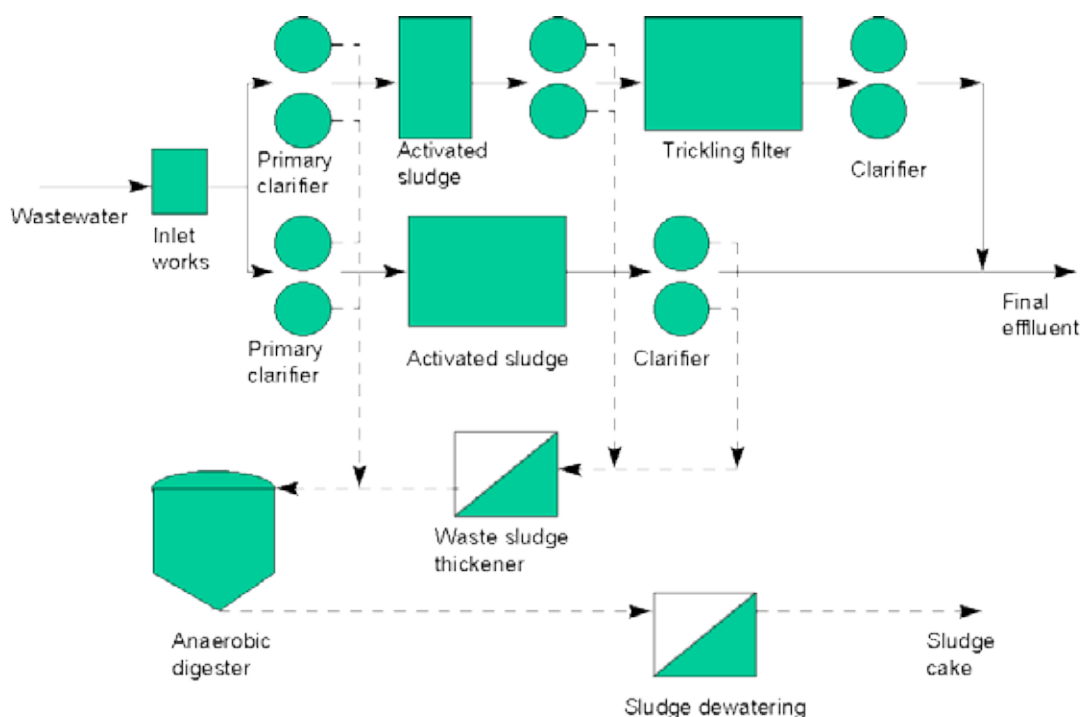
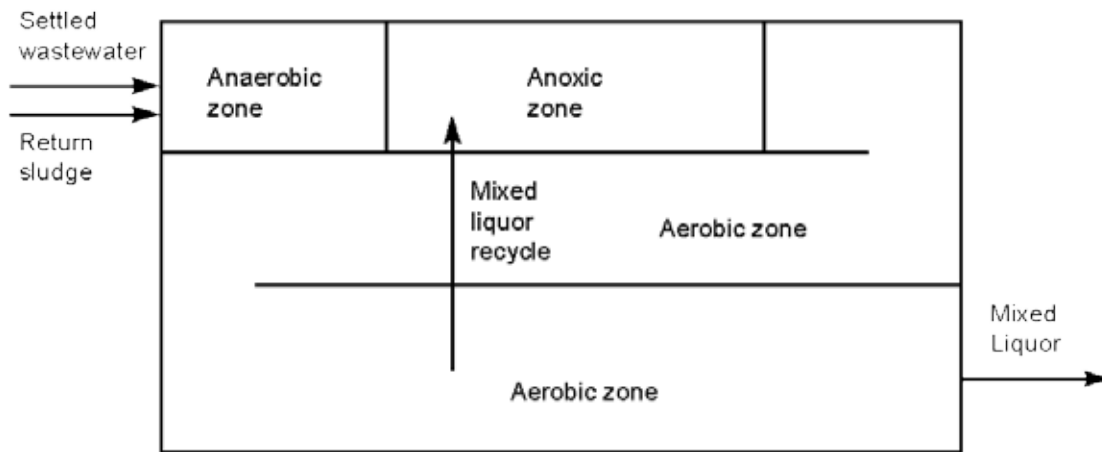

Figure 2. Schematic representation of the 3-stage Bardenpho plant at Slough.



The 3-stage configuration consists of an anaerobic/aerobic sequence to facilitate phosphorus uptake and an anoxic/aerobic recycle sequence to nitrify the ammoniacal nitrogen to nitrate and then for the nitrate to be reduced to nitrogen gas. The effectiveness of the plant to remove nitrogen and phosphorus can be seen in table 1.

Table 1. Performance of the 3-stage Bardenpho plant at Slough,

Parameter	Settled Wastewater	Final effluent
Suspended Solids mg l^{-1}	150	8
BOD mg l^{-1}	225	4
COD mg l^{-1}	500	40
Ammoniacal N mg l^{-1}	34	0.1
Total Oxidised Nitrogen mg l^{-1}	-	5.6
Total Phosphorus mg l^{-1}	10.3	0.7

From table one it is clear that the plant is producing a very good quality effluent in terms of organic pollutants and that nutrient removal is effective. The effluent contains only 17% of the incoming nitrogen and 7% of the incoming phosphorus. The nitrogen that is removed in the aeration lane is mostly lost to the atmosphere as nitrogen gas as a result of denitrification in the anoxic zone. The phosphorus, in contrast, is not lost from the system but accumulated in the waste activated sludge to the extent that the mixed liquor may contain up to 5% phosphorus⁽⁴⁾. When the sludge is exposed to an anaerobic environment, for example in anaerobic digestion, much of the phosphorus is released.

The fate of the released phosphorus is important. If the digested sludge is dewatered the released phosphorus will be returned to the incoming wastewater making good phosphorus removal more difficult. Also important is the fate of the phosphorus once it has been recycled to agricultural land. If the phosphorus is not absorbed it may be lost from the soil and could be leached into the groundwater and become a diffuse source of phosphorus. It would be advantageous if the phosphorus could be "fixed" in some way and removed from the wastewater treatment system or maintained in the sludge as a beneficial fertilizer.

Struvite Formation

Since the commissioning of the new activated sludge plant at Slough the problem of struvite formation has been exacerbated. Eight months after the new activated sludge plant was commissioned the pipework between the digesters and the digested sludge holding tank became blocked with an accumulation of small struvite crystals in a matrix of digested sludge solids. The pipework formed an inverted syphon which contained flowing sludge only when the digesters were being fed with raw sludge. The blockage occurred in the lowest horizontal and final vertical sections of the pipe which was filled with stationary sludge when the digesters were not being fed with raw sludge. The pipeline has been re-routed so that it can drain freely in the hope that this would reduce the opportunity for the struvite crystals to form. This modification appears to have been successful and the pipeline has been free from struvite since the changes were made.

Approximately one year after commissioning the new plant it became apparent that the pipeline from the digested sludge holding tank to the centrifuge had become restricted and it was not possible to transfer sludge for dewatering. In the short term the problem was overcome by laying 800 m of temporary pipework to the centrifuges whilst the extent of the problem was investigated. Dismantling the pipework around the transfer pumps revealed a significant deposit of struvite. The 100 mm diameter pipework was reduced in bore to approximately 50 mm, which accounted for the sludge pumping problem. It was not easy to determine how much of the pipeline had a struvite deposit as much of the 800 m length was underground.

During laboratory scale tests it was discovered that the struvite could be dissolved in 10% sulphuric acid. The pipeline was then "cleaned" by filling it with acid and leaving it overnight. The following day the pipeline was flushed with effluent and the spent acid was allowed to flow into the large sludge lagoons. The pipeline around the pumps was found to be clean and the pipeline was recommissioned successfully. In order to prevent further struvite deposition in the pipeline a number of options were considered before two magnetic "softening" devices, supplied by Lifescience Products Ltd. were fitted to the pipes before and after the pumps. The effectiveness of this measure is now being evaluated.

Confidence in this type of solution has been increased due to recent changes to the magnetic softener installed near to the centrate pumps. The latest modifications to this installation have reduced the incidence of pump removal and cleaning from once every two weeks to five weeks. If this kind of increased time between cleaning could be obtained for the digested sludge pipeline the acid cleaning would be needed only every two or three years which may be acceptable to operational staff.

Struvite Recovery

It is clear that generating the conditions for the precipitation of struvite is not very difficult. The greater difficulty is ensuring that the struvite formation occurs in a location where it can be recovered economically. In order to establish the best location for struvite recovery a number of streams at Slough have been monitored for a short period. These streams are:-

- The settled wastewater
- The waste activated sludge
- The waste activated sludge liquor from the belt presses
- The digested sludge
- The centrate from the digested sludge centrifuge

Samples from each stream were analysed for suspended solids, soluble phosphorus, total phosphorus and the flow has been measured, or estimated if accurate flow data was not available. These results are shown in table 2.

Table 2. Results of the analysis of potential phosphorus recovery sites at Slough.

Stream	Suspended solids mg ^l ⁻¹	Soluble phosphorus mg ^l ⁻¹	Total phosphorus mg ^l ⁻¹	Ammonia mg ^l ⁻¹	Flow m ³ d ⁻¹	Phosphorus load kgd ⁻¹
Settled Wastewater	125	8.7	11.7	34	59,000	690
Waste activated sludge	9,000	190	350	50	700	245
Waste activated sludge liquor	250	190	200	50	600	120
Digested sludge	28,500	70	800	750	300	240
Centrate	270	80	110	750	250	28

The ideal location for the recovery of struvite requires that the flow should have a high concentration of soluble phosphorus and ammoniacal nitrogen, a low concentration of suspended solids and a relatively high phosphorus load.

The results in table 2 show that none of the locations sampled is ideal for the recovery of struvite. The raw wastewater has low concentrations of phosphorus and ammonia, the waste activated sludge and the digested sludge have high suspended solids concentrations. The waste activated sludge liquor has a low ammoniacal nitrogen concentration and the centrate load is quite small. The high soluble phosphorus concentration of the waste activated sludge arises because the waste sludge is stored in a tank for about one day before being thickened.

It may be possible to combine two of the flows, the waste activated sludge liquor and the centrate to produce a more acceptable stream. The combined stream at Slough would have the composition and flow as shown in table 3.

Table 3. Flow and composition of a potential combination of the centrate with the waste activated sludge liquor.

Parameter	Value
-----------	-------

Flow	850 m ³ d ⁻¹
Suspended Solids	255 mg l ⁻¹
Soluble Phosphorus	160 mg l ⁻¹
Total Phosphorus	175 mg l ⁻¹
Ammoniacal nitrogen	255 mg l ⁻¹
Total Phosphorus Load	148 kg d ⁻¹

As the sampling programme was relatively short and some of the flows have had to be estimated an extended monitoring programme to verify these findings is required.

Conclusions

Phosphorus removal from the effluent stream at wastewater treatment plants is becoming more widespread. The options for removal lead to the phosphorus becoming concentrated in the sludge stream. It is important that the phosphorus in the sludge is held in such a way that it is not readily released and lost from the soil but is available to plants as a fertilizer. An alternative is to remove the phosphorus from the wastewater treatment plant in a managed way and for farmers to add phosphorus fertilizers to their land when it is required.

It is obvious from Thames Water's experience at Slough that struvite is one phosphorus containing compound that is very easy to precipitate. The challenge is to maintain the phosphorus in solution until it reaches a suitable point for recovery. One such suitable point at Slough would be a combined stream formed from the centrate and the thickened waste activated sludge liquor. The second challenge is to design a simple struvite precipitation process which enables the phosphorus to be successfully recovered.

References

- 1 Council of the European Communities. Directive concerning the collection, treatment and discharge of urban wastewater and the discharge of waste water from certain industrial sectors. (91/271/EEC). *Official Journal* L 135/40, 1991.
- 2 Levin, G.V. and Shapiro, J. Metabolic uptake of phosphorus by wastewater organisms. *J. Wat. Pollut. Control Fed.* 1965, **37**, p800.
- 3 Williams, S.C. and Beresford, J. The effect of anaerobic zone mixing on the performance of a three-stage Bardenpho plant. Paper accepted for the IAWQ Conference in Vancouver. June 1998.
- 4 Jardin, N and Popel, H.J. Consequences of phosphorus elimination for sludge production - a comparison between physical-chemical and enhanced biological phosphorus removal. In *Chemical Water and Wastewater Treatment IV*. Eds Hahn, H.H. Hoffmann, E and Odegaard, H. 1996.

S Short and P Nichols
Forbes Rigby Engineers

1. BACKGROUND

This poster paper describes the basis of a phosphorus removal trial being conducted at Tathra in New South Wales (NSW), Australia. The project is being managed by the NSW Department of Public Works and Services with support from the local authority Bega Valley Shire Council and with Forbes Rigby Pty Ltd and Dr Steve Short acting as research consultants.

Forbes Rigby Pty Ltd (FR) is an engineering consultancy in Wollongong, an iron & steel manufacturing and coal mining industrial city situated some 100 km south of Sydney, New South Wales, Australia. The company has performed much work over many years for the major industrial company in Wollongong, Broken Hill Proprietary Ltd (BHP). Dr Steve Short, an environmental engineer & until late 1997 an associate at FR has consulted widely to BHP and associated companies in the region on management, landfilling and beneficial reuse of slags, coal washery wastes and other byproducts of the iron, steel and coal mining industries.

Under Short's direction, FR operated a pilot plant gravel filter at BHP Stainless for 6 months, removing fluoride (a useful model anion similar in adsorptive behaviour on calcareous surfaces to phosphates) and nitrate (by denitrification stimulated by methanol dosing) from spent pickle liquors.

Short has also amassed a considerable body of both open literature and commercial research information over recent years concerning the adsorption of phosphorus (P) to calcareous soils and sediments and to calcareous industrial waste products respectively.

In late 1996, Short made a presentation to NSW Department of Public Works and Services (DPWS) on behalf of FR. This presentation promoted the merit of pilot trials of simple gravel filter beds for possible passive P removal from secondary sewage effluents in small country towns, using as filter media, reject grades of limestone or iron & steel making slags. Discharges of P contaminated sewerage effluents to inland waterways are a known contributor to the chronic problem in Australia of toxic blue green algae blooms in such waterways.

It was Short's contention that low cost adsorptive materials such as reject grades of limestone or iron and steel making slags might provide the basis for a passive, maintenance-free P removal technology at even lower cost than chemical dosing with alum, PAC, ferric chloride, lime etc. As these materials also contain magnesium (slags more so than limestone) such materials should also remove some ammonium nitrogen through surface struvite precipitation.

Subsequently, DPWS solicited from FR a fully costed design proposal from FR for a horizontal gravel bed filter pilot plant to be retrofitted to the Tathra Sewage Treatment Plant on the far NSW South Coast (~450 km from Sydney). Tathra is a small coastal town that experiences a large influx of tourists (up to 30,000) over a 6 week period in summer.

The secondary effluent sourced from the Tathra STP has a mean pH of 7.45, mean TSS of 24 mg/L and mean TP of 7.7 mg/L. At present this effluent (from two Pasveer units) is run out into a large sludge drying bed which was simply excavated into permeable coastal sands. Effluent infiltrates the local shallow aquifer and until more recently (when the drying bed was lined) this had led to nutrient pollution of an adjacent protected wetland complex.

The design proposal was submitted to DPWS by FR in June 1997.

The pilot plant project was fully costed at ~A\$110K and is designed to treat 5 - 10% of the effluent from the STP, including during the summer tourist influx, for a period of 2 - 5 years, reducing TP from ~8 mg/L to <0.2 mg/L. Costing assumed the plant would be operated for a period of 12 months although operation for a longer trial period would be possible at a running cost of only ~A\$15K/year.

After consideration of the design proposal by DPWS between July 1997 and February 1998, they agreed to fund 50% of the pilot plant from their discretionary research fund and suggested that Bega Valley Shire Council (BVSC) the relevant local authority that operates the Tathra STP, should fund the remaining 50%. BVSC recently agreed (21 April 1998) to provide these funds. It is expected that construction will commence in a month or two.

2. PROJECT GOALS

The prime purpose of this pilot plant is to test the effectiveness of the two lowest cost calcareous materials available in Australia (i.e. reject grade quarry limestone and air cooled blast furnace slag) as suitable filter media for passive P removal from secondary sewage effluents.

Most importantly, by operating the pilot plant for an adequate period of time, it is hoped to gain valuable information on P adsorption rates, the influence on those rates of accumulated biofilms and ultimate sorption capacities of these media under real world conditions (rather than those already well known from laboratory column trials etc.).

From the performance outcomes of this pilot trial it is also intended to perform cost-benefit comparisons of this approach with chemical dosing/coagulation/precipitation methods.

This project offers distinct possibilities for researching P recovery from spent media, particularly from the slag. Unlike the UK and EU countries P recovery from non-mineral sources has not yet received great attention in Australia. Prices for rock phosphate sourced from various Pacific Islands are not yet high enough in Australia to drive a concerted program of developing processes for cost effective P recovery from human and animal wastes.

Air cooled slag is a hard, stable and relatively insoluble material, being principally composed of calcium and magnesium silicate phases. If the pilot trial with air cooled slag as filter media produces a favourable outcome there are distinct possibilities for rapid P recovery and *in situ* bed regeneration using (say) dilute sulfuric acid.

It has been demonstrated in prior doctoral researches that sulfate effectively displaces phosphate from blast furnace slag surfaces. This displacement should be accomplished with minimal calcium leaching due to the limited solubility of gypsum and the common ion effect. This process is analogous to the use of sulfuric acid flooding to recover chromates from contaminated soils stabilized with barium.

Samples of slag will be recovered from the pilot plant after 12 months and possibly at longer intervals if the project is continued beyond this time. These will be saturated with solutions of dilute sulfuric acid and the liquor so produced analysed for calcium, magnesium, phosphorus, ammonium nitrogen and selected trace elements to assess the feasibility of P recovery and bed regeneration by this method.

There is also a possibility that slag beds might be able to be regenerated by simply spraying on dilute sulfuric acid i.e. using the principle of unsaturated leaching, leading to reductions in regenerate liquor volumes.

Spent filter bed material might be reusable as roadbase, or for paths in parks and gardens etc. as the adsorbed P would only be very slowly re-released to the environment. Either of these materials might also find a market as additives to horticultural potting mixes or as low cost acid soil amendments.

3. BASIC THEORY AND DESIGN

In a gravel filter medium, P removal by the adsorptive mechanism is rate dependent, being largely dictated by the mean length of the diffusion path from solution to the surface of the gravel. Hence the adsorption rate is expected to be inversely dependent on the mean interstitial dimension of the gravel, i.e. as the percentage of fines in the gravel increases so too does this rate. However, this also tends to increase the bulk density of the gravel (especially if larger sized material is absent), thereby reducing the interstitial volume and hence reducing the hydraulic residence time (HRT).

If plug flow through a gravel filter is assured, a pseudo first order (plug flow reactor) rate constant (k) for this (adsorptive) removal mechanism (i.e. where $\ln(C_e/C_i) = -k \cdot \text{HRT}$ where C_e = effluent TP concentration and C_i = influent TP, should be roughly proportional to the (weighted) mean size of the gravel (which roughly dictates the mean interstitial dimension).

Pseudo first order rate constants for total P removal in the literature on subsurface flow (gravel bed) wetlands achieving plug flow range from about 0.1/day to 1.0/day. There is good evidence to show that maintaining a large proportion of the gravel below about 7 mm in size is necessary to maximise k, i.e. to keep it nearer 1.0/day and as the mean particle size of the gravel increases, k progressively falls away.

It is useful to note this applies regardless of whether the gravel is comprised of an insoluble calcareous material or just a normal gravel as it is essentially the length of the diffusion path to the surface which dictates rate of removal.

A small finite difference model was constructed to scope various filter bed configurations and water surface profiles for a horizontal bed filter using the Dupuit-Forscheimer Equation and assuming minimum saturated hydraulic conductivity for the gravel media of 200m/day after biofilm buildup. Trench configurations (i.e. with battered slopes etc.) were also investigated in this way. Flow path analysis was used to minimise the dead volume zone near the bottom at the outlet end of the bed by adjusting an outlet weir height accordingly.

Briefly, the adopted design proposal calls for an aboveground rectangular concrete block construction of internal dimensions 8 m x 24m sited on flattened ground. The inlet end gravel height is 1.4 m and at the outlet end water would pass over a block weir of 0.4 m height.

The gravel media would have a sloping profile and be contained within a woven geomembrane liner. Effluent would be fed to the bed via a spreader bar placed on the gravel at the inlet end.

It is planned to trial two types of filter media in the gravel bed, separated by a welded-in partition (in the longitudinal flow direction) in the geomembrane liner. These media would be:

- a -40 mm reject crushed limestone sourced from Buchan in the neighbouring southern state of Victoria; and
- a -20 mm crushed air cooled blast furnace slag sourced from the BHP Port Kembla steel works, Wollongong.

The idea behind using a coarser grade of limestone than for slag is that biofilm buildup should be greater on the lower pH surface of the limestone than on the higher pH surface of the slag. Total mass of gravel media would be of the order of 150 tonnes of limestone and 133 tonnes of crushed slag. Effective startup bed porosity is about 30 vol% in each case.

4. OPERATING CONDITIONS

The brief from DPWS requires BVSC/FR/Short to operate and monitor the pilot trial for a total period of at least 12 months. This period must include or at least simulate the 6 week summer period of increased hydraulic loading and reduced hydraulic residence time in the filter.

It is intended to operate the (parallel) beds for an adequate trial period at 5% of the mean flow through the STP. Some 22.5 kL/day total would be run through the beds for 20 weeks (split half and half for each parallel filter media set) and 53 kL /day for 6 weeks, to simulate the full tourist season.

This total 6 month period would be used to monitor general hydraulic performance and in particular to determine design-specific pseudo first order plug flow reactor rate constants for total phosphorus (TP), BOD₅, suspended solids, ammonia nitrogen and faecal coliform removal in accord with published literature knowledge.

If performance for this first 6 months is adequate, it is proposed to move to an increased loading to 7.5% or even 10% of the total STP outflow for another 6 months to:

- decrease the hydraulic residence time by a factor of 1.5 or 2 to verify pseudo first order plug flow kinetics;
- accelerate the rate of mass wastage of the gravel media to possibly detectable rates; and
- monitor wetted zone profiles within the media under conditions of increased biofilm buildup (and hence reduced hydraulic conductivity and HRT).

CONTACTS FOR FURTHER INFORMATION/INTERACTION

Persons wishing to monitor the progress of this pilot plant project or comment upon its design etc. may contact:

Dr Stephen A. Short
Ecoengineers Pty Ltd
78 George Avenue
Bulli
New South Wales 2516
Australia
Tel/Fax: 61 2 42675500
Email: sashort@ozemail.com.au

or

Mr Paul Nichols
Forbes Rigby Pty Ltd
278 Keira Street
Wollongong
New South Wales 2500
Australia
Tel: 61 2 42284133
Fax: 61 2 42286811
Email: paul.nichols@forbesrigby.com.au

or

Mr Mike OHara
Department of Public Works and Services
McKell Building 2-24 Rawson Place

New South Wales 2000
Australia
Tel: 61 2 93727460
Fax: 61 2 93727477
Email: mike.ohara@dpws.nsw.gov.au

Animal wastes as a potential source of recoverable phosphorus

By Phil Hobbs, Phil Haygarth and Dave Chadwick.

Institute of Grassland and Environmental Research, North Wyke, Okehampton, Devon, EX20 2SB.

Over recent years, housing for livestock has increased substantially. In many cases, such intensification has led to larger volumes of stored waste, which are more anaerobic in nature. Pain et al (1998) estimated that approximately 90 million tonnes of farm manure was produced in the UK in 1993. Farm manure was previously considered part of the natural means of fertilising the land. These larger wastes volumes are chiefly from cattle, pig and poultry and are considered a problem. First in terms, of when and how often to landspread and second, if wastes cannot be spread on the land, how they can be stored or disposed of effectively without risk of transfer to watercourses. In particular phosphorus (P) contributes to watercourse pollution in various chemical forms and oxidative states by causing eutrophication and associated algae blooms.

Using average P concentrations of the different manure types (MAFF, 1994) and the volume of manure generated we estimate that about 100,000 tonnes of phosphorus is present in manure, chiefly from cattle, poultry and pigs. Manure is collected and stored in different forms. Poultry manure (4.3 mt) is collected as a paste like material with no added straw or absorbent bedding. Whereas cow and pig manure has straw added to about 50% of the 75 and 11 mt respectively. The other 50% is as slurry which is a mixture of urine and faeces combined with some rain water or washings. Cattle waste contains 45 kt of P but at lower concentrations than that found in pig or poultry manure.

Each of these animals has different ways of digesting and excreting waste. The cow has a rumen to digest plant material and phytase to breakdown inositol hexaphosphate. Phytase is lacking in some animals, such as the pig and chicken, which are monogastric.

The absorption of phosphorus by animals is controlled by a range of co-dependent factors that include dietary levels, vitamin D and others, as well as the health and age of the animal. Generally, about 70% of phosphorus ingested is excreted (Church 1979). Faeces generally contain more phosphorus than urine and this can be further categorised into inorganic, acid soluble, lipid and residual phosphorus (Barnett 1994).

Wastes that are stored anaerobically change in composition. Studies by Gerritse and Zugec (1977) using $^{32}\text{PO}_4$ ions on the dry matter of pig slurry demonstrated that phosphorus was cycled homogeneously to all forms within 10 to 20 weeks. The ten slurries varied in dry matter composition from 5 to 10% and the total P content was 20g kg^{-1} . The composition was approximately 15% organic P and 85% inorganic P. The latter was mainly present in the form of crystals or precipitates of calcium phosphate and was found in the solid fraction of the waste. Only 5% of the inorganic P was soluble.

Gerritse (1982) also produced a model for phosphorus cycling in slurry using labelled phosphate ($^{32}\text{PO}_4^{3-}$). It can be seen that microorganisms play a central role in cycling P forms in farm waste and manipulating this P cycle could be a possible source of recovering P effectively. Gerritse (unpublished) also found that this model was true for other farm wastes although not specifying which ones.

The value of P as phosphate in wastes is estimated as £77 million in the UK (based on 25p per kg) (Chadwick, unpublished). However, the economics of phosphorus recovery from farm wastes is difficult to evaluate. Certainly, there are higher concentrations of P in farm wastes (and especially in poultry manure) than human sewage. However economic recovery is dependent upon not only the amount present but also the means of extraction and the form of P species produced from the process. Barring interdependence of each stage mentioned above, then if microbial action were effective in modifying and/or concentrating P into an easily extractable and appropriate product this would be the preferred least-cost method.

Reference List

Barnett, G.M. (1994) Phosphorus forms in animal manure. *Bioresource Technology* **49**, 139-147.

Church, D.C. (1979) Digestive physiology and nutrition of ruminants. In Nutrition, Vol 2 ed D C Church . O and B Books, Inc., Corvallis, OR, pp62-71.

Gerritse, R.G., Dewilligen, P. And Raats, P.C. (1982) Transport and Fixation of Phosphate in Acid, Homogeneous Soils .3. Experimental Case-Study Of Acid, Sandy Soil Columns Heavily Treated With Pig Slurry. *Agriculture And Environment* **7**, 175-185.

Gerritse, R.G., Zugec I . (1977) The phosphorus cycle in pig slurry measured from $^{32}\text{PO}_4$ distribution rates. *J Agriculture Science* **88**, 101-109.

MAFF (1994) Fertiliser Recommendations for Agricultural and Horticultural Crops. RB209 Sixth Edition. HMSO. Pp112

Pain, B.F., van der Weerden, T.J., Chambers B.J, Phillips, V.R. and Jarvis, S.C. (1998) A new inventory of ammonia emission from UK agriculture. *Atmospheric Environment* **32**, 309-313.

PROSPECTS FOR THE RECOVERY OF PHOSPHORUS FROM ANIMAL MANURES: A REVIEW.

Julian Greaves*, Phil Hobbs, David Chadwick and Phil Haygarth.
INSTITUTE OF GRASSLAND AND ENVIRONMENTAL RESEARCH

North Wyke,

Devon,

EX20 2SB

UK

***Email: julian.greaves@bbsrc.ac.uk**

ABSTRACT

This paper reviews the potential for P recovery from animal manures as a method of increasing the sustainability of the global P cycle. The P content of animal manures produced annually in the UK is currently estimated at over 120,000 t. Similar quantities of P are produced in manures in the Netherlands and an estimated 600,500 t are produced annually in the US. Up to 65% of manure P may be associated with an organic moiety. However, current methods to identify these including HPLC and ^{31}P NMR are under developed while P fractionation procedures give only operational definitions. Combinations of current technologies developed for the treatment of sewage are likely to prove effective in the recovery of P from manures. Enhanced Biological Phosphorus Removal (EBPR) could be adapted to produce a concentrated P effluent. Recovery of P from which could be achieved by either of two crystallisation pathways to produce magnesium ammonium phosphate (struvite) or calcium phosphate (apatite). Recycling of manure P to land within the agricultural sector remains the best option in many cases. However, manure production in many areas such as the Great Lakes, Chesapeake Bay and the Everglades in the US, the Po Delta in Italy and the sand regions of the Netherlands is too intensive for locally available land to accommodate without the risk of transfer to surface waters. Legislation restricting recycling of P to land already exists in the Netherlands and is likely to become widely adopted. Under these circumstances recovery of P may alleviate manure management problems.

INTRODUCTION

Of the estimated 150 million tonnes (t) per year of phosphorus (P) currently extracted and processed globally, 85% is used in agriculture as fertilisers and feed concentrates. Domestic farm animals typically excrete 70% of P intake. Haygarth *et al* calculated that a typical UK intensive dairy farm of 57 ha with 129 lactating cows imported 2.48 t of P of which only 0.98 t were re-exported resulting in a net accumulation of some 1.5 t or 26 kg P ha⁻¹ y⁻¹. This was also reflected in studies by Sharpley & Withers and de Willigen & Ehlert which showed P budgets for farming systems throughout Europe and the US to be in surplus, causing an accumulation of P in agricultural soils. It has traditionally been assumed that excess P remained largely fixed in the solid phase of the soil system. However, it is now widely accepted that transfer of P from agricultural soils to surface waters occurs in sufficient quantities to present a major cause of cultural eutrophication of both inland and coastal water bodies e.g.

In order to address the problems caused by excessive loading of P to agricultural systems an integrated strategy to reduce overall P use needs to be developed and implemented. Recovery of P from farm manures presents an opportunity to directly contribute to such a strategy. The reasons for this are several fold.

1. Without careful management animal wastes can represent an important point and diffuse source of water pollution. In the UK in 1994 13% of all pollution incidents were found to originate from agriculture. In the US agriculture is responsible for an estimated 65% of all pollution incidents including 81% of BOD (biochemical oxygen demand) and 74% of total P loading to surface waters.
2. Livestock are increasingly reared under housed conditions which concentrates the production of manures into confined areas making them easily collectable. Manures produced under such conditions are currently stored, often for lengthy periods of time to reduce the viable enteric microflora, decrease volume and until spreading is legally permitted (manure spreading is prohibited in the Netherlands between Sept. 15 and Jan. 31 to reduce the risk of transfer to water). In the UK the Ministry of Agriculture Food and Fisheries (MAFF) set out guidelines of good practice, discouraging farmers from spreading manures under conditions likely to result in excessive transfer to water.
3. Build-up of excessive soil P has occurred to a greater extent in livestock, compared to arable, systems due to economic constraints necessitating operations on decreasing land areas. In the US the number of cattle and pigs have remained stable over the last 30 years while the number of cattle farms has halved and pig farms have declined five fold. Over the same period poultry farms have declined from 2.2 million to 91,000 while poultry production has increased from 2.6 million tonnes to 13 million tonnes.
4. In the Netherlands and Belgium disposal of intensively produced animal wastes is beginning to be seen as a national crisis, particularly because of the potential to cause nutrient enrichment of surface waters, a major contributory factor to the process of eutrophication. Consequently, regulations have been set whereby application of manures to farmland is restricted to a maximum of 48 kg P ha⁻¹ y⁻¹ with a levy to be imposed on surpluses. Similar restrictions are likely to be implemented in areas of P accumulation throughout the EU and the US in the near future. In the UK, current manure application policy is based on nitrogen (N) loading rates of 250 kg ha⁻¹ according to MAFF. N:P ratios in manures are generally in the region of 2-6:1 whereas most cropping situations require a ratio of 7-11:1. Consequently, manure applications based on N requirements represent significant P surpluses.

5. As much as 65% of P in animal manures occurs in organic forms which are often soluble or colloidal in nature and do not become readily fixed in the soil. Therefore manure P is more prone to leaching via hydrological pathways than inorganic P from artificial fertilisers .

6. Manure application to agricultural land replenishes organic matter, improving the structure, water retention and cation exchange capacities of the soil. Reduction in the nutrient load of manure would allow the continued benefit of these attributes while reducing the threat of eutrophication.

7. Recovery of P in a form suitable for fertiliser use has the potential to enable farmers to better control the application of P and its release rate to the soil, reduce the need to import further P fertilisers and reduce the cost of exporting nutrients to less susceptible or P deficient areas.

MANURE PRODUCTION AND DEFINITIONS

Currently 80 to 90 million t of manures are collected in farm buildings in the UK annually. Using average P concentrations reported by MAFF for different manure types this represents c.120,500 t of P (Table 1). Manure production by the Dutch national herd and its P content is broadly similar to the UK . However, land area in Holland is only one sixth that of England with the highest population density in Europe so production is concentrated in far smaller areas . In the US Sutton *et al.* estimates that 62.5 million t (dry weight) of manures are collectable annually from housed animals. Assuming the same ratio of slurry:FYM and similar P contents as reported by MAFF (Table 1), this equates to c.582 million t fresh weight containing some 600,500 t P. This represents a considerable management problem. Several types of manure are produced on the farm each with its own particular properties depending on the type of livestock and the procedure under which they are produced.

Dirty waters

Dirty waters are dilute effluents with dry matter contents (DMC) of <0.5% produced by washing down of dairy collecting yards, milking parlours and equipment. Being of such a dilute nature, these effluents have a very low P content and as such offer little prospect of economically viable recovery on their own. However, dirty waters may be effective as aqueous additions for the treatment of manures with higher DMC.

Slurries

Slurries are homogenous mixtures of dung, urine and washing down waters produced from dairy, beef or pig housing on slatted or scraped concrete floors in the absence of bedding material. Slurries typically have DMC of 3-5% for pigs and 7-10% for cattle. The mean P content is in the order of 0.5 kg t⁻¹ for cattle slurries and 1.3 kg t⁻¹ for pig slurries . Slurries should be contained in specialist storage vessels or ponds for a minimum period of up to 4 months .

Farm Yard Manures (FYM)

FYMs are heterogeneous mixtures of excreta and bedding material, except for poultry manures which may be produced in the absence of bedding. Dry matter contents of c.25% for cattle or pigs and up to 60% for poultry litters are typical. Average P contents of 1.5 kg t⁻¹ for cattle, 3 kg t⁻¹ for pigs and 5.7 - 10.9 kg t⁻¹ for poultry are reported by MAFF . FYM is a stackable product which can be easily stored in a confined yard with adequate drainage capture .

Table 1. UK manure production during housing and average P content, from MAFF .

Animal	Enterprise	Animal N ^o . (10 ³)	Manure type	Manure (tonnes)	Average P content (kg t ⁻¹)	Total P in Manure (tonnes)
Cattle	Dairy		slurry	26,073,240	0.5	13,037
	Dairy		FYM	5,977,395	1.5	8,966
	Dairy	3195	dirty water	2,613,857	0.1	261
	Beef		slurry	12,152,560	0.5	6,076
	Beef	8719	FYM	26,597,400	1.5	39,896
Pigs			slurry	4,890,963	1.3	6,358
		7497	FYM	4,364,582	3.1	13,530
Poultry	Broiler	79504	FYM	1,669,584	10.9	18,198
	Layer	32824	FYM	1,378,608	5.7	7,858

Pullet	10653	FYM	149,142	5.7	850
Other hens	5989	FYM	251,538	5.7	1,434
Duck	2341	FYM	102,536	5.7	584
Turkey	9548	FYM	311,456	10.9	3,395

86,532,861

120,443

TOTAL

Currently all pig and cattle manures produced in the UK are spread to land, 76% of cattle manures to grassland with the remainder to arable, whereas 90% of pig manures are spread on arable land with only 10% on grassland . The majority of poultry manures are spread on arable land. However, the electricity generating company Fibrowatt currently incinerates 265,000 t y⁻¹ in Eastern England to produce electricity and will soon take a further 400,000 t y⁻¹ . The ash produced has a P content of 10.7% and is sold as an agricultural fertiliser.

PHOSPHOROUS FORMS IN ANIMAL MANURES.

Few studies on the forms of P in manures are reported in the literature. Chemical identification of P forms is difficult due to the highly reactive nature of the trivalent PO₄³⁻ group and its propensity towards hydrolysis from the organic moiety during extraction procedures. Current understanding of P speciation therefore relies largely upon operational definitions according to fractionation techniques (Figures 2 & 3). Monoester and diester forms of organic P, polyphosphate and orthophosphate have been characterised from soil extracts using ³¹P Nuclear Magnetic Resonance (NMR) e.g. . However, Preston reported that little attempt has been made to further develop the technique or to quantify the extent to which sample preparation causes hydrolysis of the PO₄³⁻ linkage to occur. High pressure liquid chromatography (HPLC) has also been used to measure the monoester inositol hexaphosphate (IHP) and ATP in soil extracts .

The bulk of manures quickly become anaerobic during storage due to microbial oxidation of labile carbon sources. Difficulties in chemical identification of phosphate molecules means that the pathways and kinetics of P cycling in manures under storage are poorly understood. However, Gerritse and Zuege used ³²PO₄ to study the rate of isotopic distribution of P in both aerated and non-aerated pig slurry and produced a simple model of the P cycle (Figure 1). Gerritse and Zuege found that labeled P added to pig slurry was rapidly cycled to all measurable fractions, undergoing complete turnover in 10 - 20 weeks. They concluded that the driving force for P cycling was microbial activity and that all organic and inorganic P in stored manures took part in the cycle. Gerritse and Zuege also concluded that typical organic/inorganic partitioning reported in the literature could be regarded as an equilibrium value.

P complexes with organic and inorganic particulates

P_i complexes with



DOM* P_i calcium phosphate

DOP**

* dissolved organic matter

** dissolved organic P Figure 1. Model of P cycling in stored manures.

Fractionation procedures

Two conceptually different approaches to P fractionation have been reported, those of McAuliffe & Peech and Hedley . Both are complex and time-consuming procedures which do not lend themselves to frequent routine monitoring.

The Mc Auliffe & Peech fractionation technique was developed from earlier attempts by other workers reported therein. This technique (Figure 2) involved the initial conceptual separation of total P (P_t) into inorganic and organic forms (P_i & P_o respectively) by directly measuring P_i in the liquid fraction and subtracting this from P_t to give P_o . P_o was then separated into three further fractions by two extraction procedures. An ether extraction presumed from chemical principles to remove the lipid fraction (P_l) and an acid extraction presumed to remove the phytate fraction (P_{aso} for acid soluble). The remaining or residual P fraction (P_r) was taken to represent the more recalcitrant nucleic acids.

TOTAL-P

molybdate reactive P $P - P_i = P_o$

P_i P_o

ether extract acid soluble residue

P_l P_{aso} P_r

Figure 2. Simplified schematic of the fractionation procedure of McAuliffe & Peech .

The Hedley procedure was devised for the fractionation of P compounds in soil extracts and later modified by Tiessen *et al.* (Figure 3). This procedure differs from the McAuliffe and Peech approach in that it relies on the chemical fixation of hydrolysed PO_4^{3-} ions to eluents of increasing strength introduced in a stepwise fashion to remove increasingly recalcitrant P forms. The modified Hedley fractionation technique was recently used by Leinweber *et al.* for analysis of P compounds in animal manures followed by ^{31}P -NMR spectroscopy to identify orthophosphate and monoester and diester-linked PO_4^{3-} groups. Leinweber *et al.* concluded that the alkaline extraction technique could promote the hydrolysis of diesters to the monoester form and advised the systematic investigation of all methodological aspects of sample treatment.

TOTAL-P inorganic

resin extract

resin-P

Olsen bicarbonate

$NaHCO_3$ -P

NaOH

NaOH-P H_2SO_4

H_2SO_4 -P

Figure.3. Simplified schematic of Modified Hedley Fractionation.

Barnett used a modification of the McAuliffe & Peech method described above to quantify P forms in a range of fresh animal faeces while simultaneously comparing these with literature values. Barnett reported wide variation in the P fractions measured which he expressed as coefficients of variation (Cv) (Table 2). Such variation is widely reported in the literature and is likely to reflect both experimental variation and a range of dietary and health factors described by Church .

Table 2. Phosphorus composition in fresh faeces*. (From)

P_t (g kg ⁻¹)	Cv%	P_i	Cv%	P_l	Cv%	P_{aso} %	Cv%	P_r	Cv%
-----------------------------	-----	-------	-----	-------	-----	-------------	-----	-------	-----

Beef	6.7	32.0	48.3	12.1	1.9	0.7	8.9	4.0	40.8	11.3
Dairy	9.3	32.4	63.2	5.1	1.4	0.3	7.8	3.6	27.7	18.4
Pig	29.1	18.3	54.7	20.3	0.4	15.8	29.7	41.6	15.2	36.0
Broiler	18.0	16.7	34.8	31.1	0.9	33.4	53.4	24.4	11.0	45.7
Layer	24.2	17.4	49.3	21.4	0.6	19.5	33.2	20.2	17.3	41.2

* Dry matter basis.

P_i = inorganic P

P_l = lipid P

P_{aso} = acid soluble P

P_r = residual P

PHOSPHORUS RECOVERY TECHNOLOGIES.

Concerns over nutrient loading to the environment from municipal sewage have led to the development of a wide range of technologies for the removal of P from effluents. These have been comprehensively reviewed by Brett *et al.* and can be broadly grouped into three categories; physico-chemical, biological and crystallisation processes. In all but the P crystallisation processes the principal aim of the treatment is to trap mobile P in the sludge solid fraction to prevent discharge in the aqueous effluent. The task of recovering P from animal wastes has essentially the opposite aims to these technologies and stands more to gain from the crystallisation processes. However, biological treatment is effectively used to produce a concentrated feed stream prior to crystallisation. The prospects for adaptation of these technologies from sewage treatment to recovery of P in animal manures are good because P and labile carbon sources are more concentrated in manures than sewage. In the Netherlands the DHV Crystalactor process and a struvite crystallisation process have both been tested on manures with some success.

Phosphorus crystallisation processes

Brett *et al.* summarises seven crystallisation processes (table 4) some of which are in full operation while others remain at the lab scale. These processes use two reaction pathways to produce either calcium phosphates (reaction 1) or magnesium ammonium phosphate, otherwise known as struvite (reaction 2). Calcium phosphates can be recycled to the P industry while struvite can be used as a slow release fertiliser.

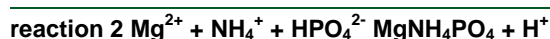
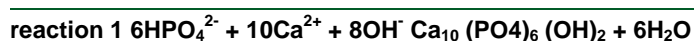

Reaction of PO_4^{3-} with Ca^{2+} can form a number of related products depending on reaction conditions, the solubility products of which increase with $\text{Ca}^{2+}:\text{PO}_4^{3-}$ ratio (table 3).

Table 3. Calcium phosphate compounds .

Compound	Formula	Abbreviation	pKa ⁻
Dicalcium Phosphate	$\text{CaHPO}_4 \cdot 2\text{H}_2\text{O}$	DCP	6.5
Tricalcium Phosphate	$\text{Ca}_3(\text{PO}_4)_2$	TCP	26.0
Octacalcium Phosphate	$\text{Ca}_8\text{H}(\text{PO}_4)_6$	OCP	46.9
Hydroxy Apatite	$\text{Ca}_5(\text{PO}_4)_3\text{OH}$	HAP	57.8
Flour-apatite	$\text{Ca}_5(\text{PO}_4)_3\text{F}$	FAP	60.4

* pKa = negative logarithm of activity product.

Table 4. Phosphorus crystallisation processes. (from)

Process name	Operation status	Crystallisation process	Seeding material	Recovered product
The DHV Crystalactor™ Pelletiser	fully operational	fluidised bed	sand / anthracite	calcium phosphate pellets
The CSIR Fluidised Bed Crystallisation Column	lab scale only (1992 report)	fluidised bed	quartz sand	HAP
The Kurita Fixed Bed Crystallisation column	fully operational	fixed bed	phosphate rock	HAP
OFMSW* & BNR**	lab scale only	packed bed & fluidised bed	quartz sand	HAP or struvite
The RIM-NUT ion exchange process	demonstration plant	precipitation	none	apatite
The Unitika Phosnix process	fully operational	spontaneous nucleation in air agitated column	none	apatite
The Sydney Water Board reactor	Pilot scale	agitated upward flow reactor	magnesia particles	calcium phosphate

* Organic Fraction Municipal Waste

** Biological Nutrient Removal

Biological Phosphorus removal

The ability of activated sludge microflora to take up dissolved P beyond the requirements for growth has been appreciated since the work of Greenburg *et al.* and Srinath *et al.*. A great deal of work has superseded these early investigations and the phenomenon has been widely used to develop Enhanced Biological Phosphorus Removal (EBPR). EBPR is a process designed to enhance the natural ability of certain bacterial strains to accumulate large quantities of dissolved inorganic P and store it in insoluble polyphosphate granules known as volutin. The basis of this technology is to introduce an anaerobic front end stage to the standard activated sludge sewage treatment system followed by secondary and in some cases tertiary anoxic or anaerobic stages arranged to create an alternating system of aerobic and anaerobic conditions.

Under anaerobic conditions the polyphosphate accumulating microflora hydrolyses stored internal polyphosphate, releasing dissolved P_i into the aqueous phase in order to take up short chain fatty acids (SCFA's) produced by fermentative bacteria in the absence of oxygen. The SCFA's are stored as poly- β -hydroxy alcanoates (typically valerate and butyrate) until they can be oxidised. Under subsequent aerobic conditions these bacteria use the stored carbon compounds for rapid growth and uptake of available P in a mechanism termed luxury uptake. This process is widely used in sewage treatment to reduce P concentration in the effluent frequently by 80% - 90% often to below 1 mg P l⁻¹. The operational performances of several biological P removal plants are summarised by Brett *et al.*

The use of EBPR, as described, to remove P from the aqueous phase and trap it in the sludge solids is essentially the opposite process to that required for the recovery of P from manures. Ideally, recovery of P will require the liberation of trapped P to the aqueous phase in a pure enough form for a process such as crystallisation to occur. This is currently achieved by using the P release mechanism during SCFA uptake under anaerobic conditions to produce a phosphate enriched stream. Work on the stimulation and measurement of this process is presented by Gerber *et al.* and van Niel *et al.*. Theoretically, animal manures should present excellent sludge bases for this process because they are generally far richer in both labile carbon sources and P than municipal sewages.

DISCUSSION

Where possible, land spreading remains the preferred option for recycling of animal manures provided that adequate measures are taken to prevent run off and leaching to surface and ground waters. This will require a better awareness on the part of farmers of the nutrient content of both their manures and the soils to which they are to be applied. In order to prevent a build up of excess P in agricultural soils a significant reduction in the use of inorganic fertilisers may also be required to enable continued land application of manures. Under present guidelines in the UK land spreading is possible in most situations even if this is not at the point of production. UK animal production is sufficiently geographically widespread for the majority of wastes to be accommodated locally with minimum transport costs. This is not so in many parts of Europe and the US where animal production is often highly concentrated in specific geographical regions. In these situations transport of manures to receiving areas may represent a significant cost to the producer.

Economic studies in the US indicate that the fertiliser resource value of cattle manure provides a maximum economically viable transportation distance of 14.5 km while for liquid slurries distances are considerably shorter. In the UK manure is applied according to a maximum N loading rate of $250 \text{ kg ha}^{-1} \text{ y}^{-1}$ which represents a significant excess of P. Legislation in the Netherlands restricts manure application according to a maximum P loading of $48 \text{ kg ha}^{-1} \text{ y}^{-1}$ to arable land and $59 \text{ kg ha}^{-1} \text{ y}^{-1}$ to grassland. Consequently, this enables disposal of far smaller volumes of manure. Van Voorneburg *et al.* report that if all available manure management options are fully used a national Dutch surplus of $8,000 \text{ t P y}^{-1}$ will still occur by 2002. If legislation of this nature is adopted in the UK and the rest of Europe significant manure surpluses are likely to be produced. Under these circumstances manure processing to recover nutrients may become an attractive proposition as it will enable land disposal of greater manure quantities at source. Recovered P could be used in areas where manure spreading is not permitted, as a supplement to imported inorganic fertiliser or exported from source at a fraction of the cost of manure transportation.

Several manure processing initiatives were set up in the Netherlands during the 1980s and early 90s. These included biological treatment to reduce sludge volume and nitrogen content, de-watering and recycling into animal feeds, liquid/solid separation, incineration, wet oxidation and precipitation and crystallisation of manure P. Many of these initiatives including a central manure bank received government subsidies. However, in 1995 subsidies for large scale manure processing and long distance transport were prohibited in the EU rendering such operations uneconomic. Therefore, processing at source is likely to become the only economically viable option.

Phosphorus content is highest in pig and poultry manures (tables 1 & 2). These are also the most intensively managed sectors producing large concentrations of manures and, being largely land independent, are most likely to experience a disposal problem. In 1996 the Netherlands produced c.14.5 million pigs and c.91.5 million chickens producing 22,327 t and 12,664 t of P respectively. Recovery of P from key producers in these sectors alone would negate the predicted surplus.

Treatment of poultry manure in Europe has, to date, focused largely on incineration and in some cases gasification to produce energy. Several incineration schemes developed throughout Europe are outlined by van Voorneburg *et al.* all of which have been closed down due to excessive pollution from the flue gasses.

In the UK there are currently two electricity generating facilities fuelled by poultry manure in Suffolk and Lincolnshire with a combined capacity of $265,000 \text{ t y}^{-1}$ and a third is under construction in Norfolk with a capacity of $400,000 \text{ t y}^{-1}$. Van Voorneburg *et al.* argue that these plants are only economical because of the high returns from non-fossil fuel electricity generation peculiar to the UK. Ash from these plants is reported to have a P content of 10.5% and, sold within a 70 km radius of production for the same price as mineral fertiliser, is well received generating much repeat business. Poultry manure is particularly suitable for incineration because of its high DMC (60% DMC is required for efficient incineration). Providing emission standards are maintained this may in some cases prove to be the best practical option for disposal.

Recovery of P from manure can be achieved by crystallisation techniques outlined in Table 4 developed for P recovery from municipal sewage. These can be categorised into two groups depending on whether the recovered product is a calcium phosphate or struvite. Both these techniques hold much promise for recovery of P from animal manures. Struvite recovery from veal calf manure has been successfully achieved in the Gelderland province of Holland where this industry is most concentrated and where the local soils are unsuitable for land disposal. Schuiling and Andrade also found the process worked well for diluted poultry manure but poorly for pig manure. Struvite crystallisation in this report was carried out directly in the sludge by addition of MgO to create the correct stoichiometric balance and an increase of pH to about 9 (method not stated), without prior P separation in a concentrated stream. For the formation of struvite to occur the dominant form of dissolved P must be in the form of PO_4^{3-} which is so under alkaline conditions. This process will only remove the inorganic fraction of P from manures, not the organic fraction which may be over 50% of P_i (Table 2).

The use of EBPR technology to hydrolyse organic P and produce a concentrated effluent stream for struvite recovery may enhance the process considerably by increasing the proportion of P recoverable, reducing the quantities of chemical additives needed to create a suitable reaction environment and increasing the relative quantity of P in the recovered product. Biological processing has the added advantage of reducing sludge solid volume by oxidation of labile carbon sources to CO_2 , CH_4 and water. Biological hydrolysis of organic P may also enable struvite recovery from pig manure which has otherwise been unsuccessful. Struvite has potential as an agricultural fertiliser for, as well as containing P, it also contains both magnesium, which plants require in a ratio of 3:2 Mg:P, and nitrogen. Release of nutrients is slow, thus minimising the possibility of transfer to surface waters yet it is citrate soluble and hence available to plants. However, little co-ordinated work has been reported regarding its performance as a fertiliser in the field. Production of struvite is unlikely to be appropriate in the non-agricultural sector as existing technologies for the extraction of P are geared towards removal from calcium phosphates which are incompatible with struvite P recovery.

Calcium phosphate recovery has also been attempted from veal calf manure using the DHV Crystalactor process (Table 4) with some success. However, performance was hampered by various technical problems such as CO_2 stripping and research was instead focussed on the struvite recovery process. Several areas of research needed to advance both of these technologies have been suggested. For calcium phosphate recovery these include;

1. Chemical reactor conditions including pH control.
2. Physical reactor conditions including flow rates and turbulence required to optimise pellet formation.
3. The role of different seeding materials in increasing the product purity.

and; in the case of struvite

1. Further evaluation of the agricultural value of struvite.
2. Determination of optimal nucleation and growth conditions.
3. Controlling the purity of the recovered product under "real" conditions.
4. Production of different forms of struvite.
5. Evaluation of the most effective crystallisation technique (precipitation or fluidised bed).

Despite over 40 years of research into the phenomenon of biological phosphorus removal and over 2 decades of its application as EBPR in sewage treatment, several key aspects of the process remain poorly understood and much contradictory evidence still abounds. This is particularly so regarding the bacterial species involved, their interactions and community structures, especially how these are affected by the physical and chemical conditions under which they develop e.g. . The paucity of techniques reported for specific chemical identification of P forms mean that the transformations, pathways and kinetics of P cycling during EBPR remain unclear. If EBPR is to be truly optimised and adapted to P removal from animal manures these areas and how they are effected by the specific physical and chemical conditions presented by the different manure types must be a research priority. Further studies such as Gerritse & Zugek using labeled P coupled with microbiological studies and more detailed identification of P species should be carried out during the EBPR process. This may help identify which members of the microflora are responsible for liberation of which P fractions and what specific conditions are required to develop a microflora best suited to treatment of particular manure types.

For the economic recovery of P from manures at the point of production any system employed must be low cost and simple, requiring minimal maintenance and minimum input of chemicals. Consideration must also be given to the length of time the process will take because this will impact on the quantity of manure being processed at any one time and so the capacity of the process equipment required. Phosphorus recovery should not render the treated manure unusable by contamination during the treatment process.

Conclusions

In many areas manure P is surplus to requirement and is a major cause of nutrient enrichment to both land and surface waters. Legislation to reduce nutrient enrichment is likely to increase manure surpluses in the future. In the majority of UK based livestock farming systems production is to some extent land dependent. Therefore, more careful overall phosphorus management may, in most cases, alleviate the potential to cause environmental problems. Where this is not the case P recovery may prove to be an attractive option in the overall management of P use. Recovery of P is in accordance with the notion of sustainability in agriculture and may prove to be an effective tool in the reduction of surface water eutrophication especially in areas where intensive livestock production is commonplace.

Technologies developed for phosphorous recovery in the treatment of sewage are likely to be adaptable to recovery from manures. Of these technologies biological treatment coupled to a crystallisation process seems to hold the most promise. Recovery of P from animal manures is unlikely to be economically viable in its own right. However, future legislative restrictions on P loading to the environment are inevitable and are likely to make P recovery from manures a more attractive management option for the farmer. Development of technologies for P recovery from manures will help to enable farmers to cope with such changes while simultaneously helping to protect the environment from cultural eutrophication and conserve P resources for future generations.

BIBLIOGRAPHY

55. Condon, L.M. Fossard, E. Tiessen, H. Newman, R.H. and Stewart, J.W.B., Chemical nature of phosphorus in cultivated and uncultivated soils under different environmental conditions. *J. Soil Sci.* **41** 41-50.

What can the industry handle
Dees Lijmbach
P-recovery workshop
Warwick 6th May 1998

Phosphate rock

1																	2
H																	He
3	4											5	6	7	8	9	10
Li	Be											B	C	N	O	F	Ne
11	12											13	14	15	16	17	18
Na	Mg											Al	Si	P	S	Cl	Ar
19	20	21	22	23	24	25	26	27	28	29	30	31	32	33	34	35	36
K	Ca	Sc	Ti	V	Cr	Mn	Fe	Co	Ni	Cu	Zn	Ga	Ge	As	Se	Br	Kr
37	38	39	40	41	42	43	44	45	46	47	48	49	50	51	52	53	54
Rb	Sr	Y	Zr	Nb	Mo	Tc	Ru	Rh	Pd	Ag	Cd	In	Sn	Sb	Te	I	Xe
55	56	57	72	73	74	75	76	77	78	79	80	81	82	83	84	85	86
Cs	Ba	La	Hf	Ta	W	Re	Os	Ir	Pt	Au	Hg	Tl	Pb	Bi	Po	At	Rn
87	88	89	104	105	106	107	108	109	110								
Fr	Ra	Ac	Rf	Db	Sg	Bh	Hs	Mt	Uun								
58	59	60	61	62	63	64	65	66	67	68	69	70	71				
Ce	Pr	Nd	Pm	Sm	Eu	Gd	Tb	Dy	Ho	Er	Tm	Yb	Lu				
90	91	92	93	94	95	96	97	98	99	100	101	102	103				
Th	Pa	U	Np	Pu	Am	Cm	Bk	Cf	Es	Fm	Md	No	Lr				

The industry

The industry is:

European manufacturers of detergent grade phosphates

Working together on research projects under CEFIC umbrella

The industry

- Based on limited natural P-rock resources

- Major processing routes (besides fertilizers)

1) Conversion into

- phosphoric acid (wet route)
- phosphorus (thermal route)

2) Production of detergent phosphate (STPP)

Phosphate rock

- Apatite : $\text{Ca}_{10}(\text{PO}_4)_6 \text{X}_2 \text{X} = \text{F, OH, others}$
 - Sand-like material
 - Deposits all over the world
 - sedimentary
 - magmatic
 - Variations in composition
 - Variations in processability
 - A material with numerous contaminants
-

Phosphate rock

Contaminants

What are we talking about ?

>Phosphate rock

A typical analysis

phosphate as P_2O_5 : 30 - 38 %
Calcium as CaO : 45 - 55 %
Fluoride : 1 - 4 %
Iron as Fe_2O_3 : 0 - 2 %
Aluminium as Al_2O_3 : 0 - 1 %
others like (heavy) metals, ra-nucleids, organic carbon

Process routes

The thermal route

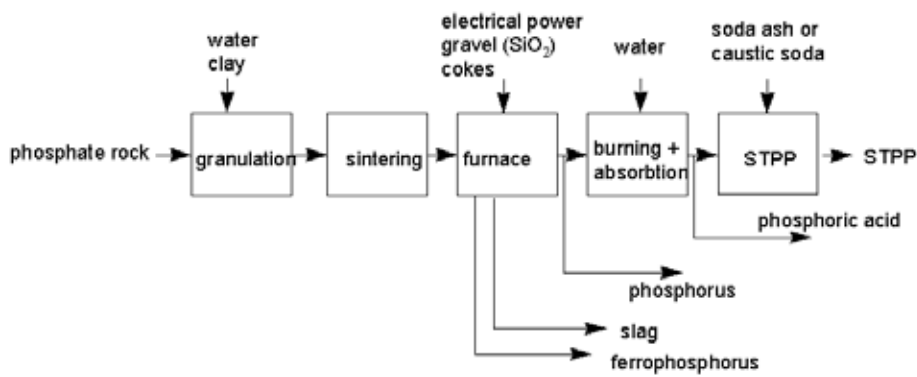

The wet route

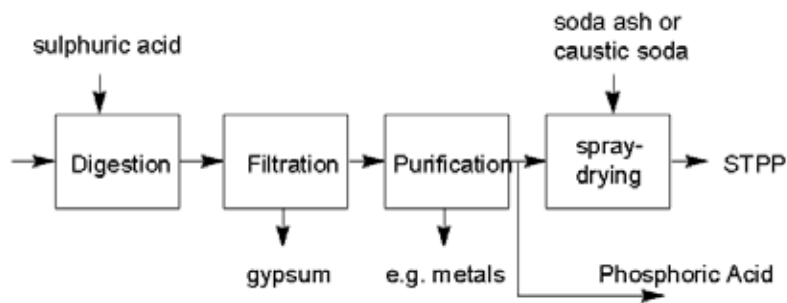

Possible Alternatives

Wastewater treatment sludges

- biological
- chemical
- Incineration ashes

Calciumphosphates

Struvite

Manure

- Incineration ashes poultry manure
-

Possible alternatives

An assesment of hurdles

Low P₂O₅ content : economics (W/T)
high Fe / Al content : process restrictions (W/T)
economics (T)
organics / carbonates : process restrictions (W/T)
silicates : process restrictions (W)
(heavy)metals : process restrictions (W/T)
emissions (W/T)
physical appearance : process restrictions (W/T)

The way forward

Phosphate recycling through combined efforts of :

- industry
- waste water treatment works
- government
- agriculture

has the possibility to lead to a win-win situation for all participants.

Crystallization Process Enables Environmental Friendly Phosphate Removal at Low Costs

Andreas Giesen

DHV Water BV, P.O. Box 484, 3800 AL Amersfoort, The Netherlands, Tel: +31 33 4682497,

Fax: +31 33 4682301, Email: A.Giesen@WA.DHV.NL

Abstract

An advanced alternative for phosphate removal by conventional precipitation is to apply crystallisation. DHV, a multi-national group of consulting engineers and general contractors with headquarters in The Netherlands, has developed and patented a fluid-bed type of crystallizer in which phosphate is removed and recovered from the wastewater while phosphate pellets with a typical diameter of 1 mm are produced. The major advantages of the crystallisation technology, the so-called Crystalactor®¹, are that (1) the installation is compact, (2) phosphate pellets with a high-purity are produced, (3) the produced pellets have an extremely low water content (5% to 10% moisture) and (4) the pellets can be reused. Up to now Crystalactor plants were constructed for the removal/recovery of heavy metals, phosphate, fluoride and the softening of drinking and process water.

¹The Crystalactor® is the registered trademark of the pellet reactor systems developed by DHV Water BV, Amersfoort, The Netherlands, for water treatment.

1 CONVENTIONAL PHOSPHATE REMOVAL

In municipal water applications and many industrial unit operations phosphate-polluted wastewater is generated.

In general, conventional phosphate removal techniques are applied for the wastewater treatment. These conventional processes are based on the phosphate precipitation as calcium or iron salt or fixation in activated sludge. These processes unfortunately generate huge amounts of a water-rich sludge which has to be disposed off at continuous increasing costs. To minimise disposal costs, the sludge is often mechanically dewatered prior to disposal. Typically, even after dewatering the water content of the sludge still amounts to 60% to 85% and a relatively large part of the disposal costs comes from the expensive disposal of water. Due to high water content and the low quality of the waste sludge, reuse of phosphate is not an economic attractive option. Furthermore the operation of mechanical dewatering equipment is often troublesome. Also the area requirement for conventional phosphate precipitation processes is relatively high because of the four process steps are performed serially. They are (also refer to Figure A):

- coagulation
- flocculation
- sludge/water separation
- sludge dewatering

2 CRYSTALLISATION IN A CRYSTALACTOR®

An advanced alternative is to apply crystallisation instead of precipitation. The Crystalactor®, a fluid-bed type of crystallizer, has been developed for this purpose. Instead of bulky sludge, this process generates high purity phosphate crystal pellets that can be re-used in many ways. Recovery of phosphate because more and more important since it is a sustainable solution to the environmental problems related to the mining and processing of natural phosphate resources.

The Crystalactor enables phosphate removal and recovery by means of several process routes. The most important routes are:

- crystallisation as calcium phosphate (CP)
- crystallisation as magnesium phosphate (MP)
- crystallisation as magnesium ammonium phosphate (MAP)
- crystallisation as potassium magnesium phosphate (KMP)

2.1 Process description

Actually, the chemistry of the process is comparable to the conventional precipitation. By dosing a calcium or magnesium salt to the water (e.g. lime, calcium chloride, magnesium hydroxide, magnesium chloride), the solubility of CP, MP, MAP or KMP is exceeded and subsequently phosphate is transformed from the aqueous solution into solid crystal material. The primary difference with conventional precipitation is, that in the crystallisation process the transformation is controlled accurately and that pellets with a typical size of approx. 1 mm are produced instead of fine dispersed, microscopic sludge particles.

Principle

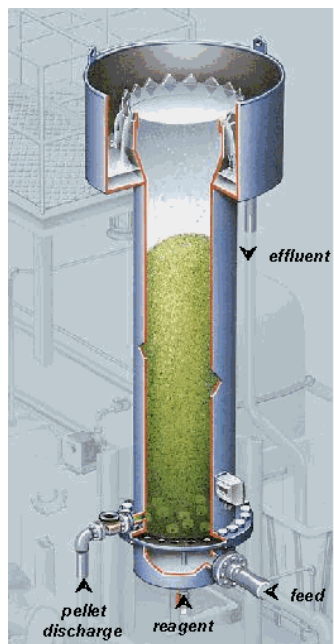

The Crystalactor® is a cylindrical reactor, partially filled with a suitable seed material like sand or minerals. The phosphate-containing wastewater is pumped in an upward direction, maintaining the pellet bed in a fluidised state. In order to crystallise the phosphate on the pellet bed, a driving force is created by a reagent dosage and sometimes also pH-adjustment. By selecting the appropriate process conditions, co-crystallisation of impurities is minimised and high-purity phosphate crystals are obtained.

The pellets grow and move towards the reactor bottom. At regular intervals, a quantity of the largest fluidised pellets is discharged at full operation from the reactor and fresh seed material is added. After atmospheric drying, readily handled and virtually water-free pellets are obtained.

2.2 No Residual Waste

A major advantage of the process is its ability to produce highly pure, nearly dry phosphate pellets. Table A shows the typically characteristics of the pellets in comparison with precipitation sludge.

Table A: comparison of characteristics

Parameter	crystallisation in pellet reactor	conventional precipitation
morphology	round pellets 0.8 - 1.0 mm 1 - 5 %< 5 % 90-98 %	sludge 60 - 85 % (after dewatering) - 20 - 30 % (after dewatering)
water content		
seed material content		
CP, MP, MAP, KMP-content		

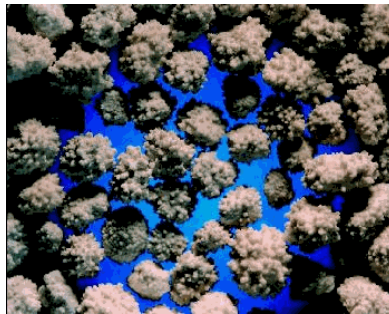

No copious amounts of waste sludge, but compact reusable pellets (shown magnified)

Due to their excellent composition, the pellets are normally recycled or reused in other plants, resulting in no residual waste for disposal. Several reuse options are:

- raw material for the production of phosphoric acid in either the wet or thermic production processes
- intermediate product for fertiliser formulation
- raw material for kettle food
- direct use as (slow-release) fertiliser

Phosphate processing industries have expressed interest in reusing Crystalactor pellets since it shows to be an attractive and clean (low in heavy metals) secondary phosphate source.

In the rare event that pellets have to be disposed of by other means, the advantage of low-volume secondary waste production still remains: water-free pellets, not bulky sludge.

2.3 Capacity and effluent concentrations

The reactivity of phosphate is reflected in the crystallisation process and high reactor loadings can be applied. The reactivity for MP, MAP and KMP is even substantial higher (factor 3-5) than for CP.

Depending on the pH and the calcium or magnesium dosage rate, phosphate can be removed from the wastewater down to low concentration levels. The phosphate concentration in the effluent from a pellet reactor when treating a typical wastewater stream depends on the applied process route. With the CP-route effluent concentration below 0.5 mg P/l can easily be obtained, while the other routes result in effluent containing typically 5-10 mg P/l. If the Crystalactor is applied in a side-stream, as is the case in combination with biological phosphate removal, the actual effluent quality discharged by the Crystalactor-unit is less important. In this case the crystallisation capacity determines the overall performance.

As result of the high reactor capacity, the high surface loadings (40-120 m/h) and since the coagulation, flocculation, separation and dewatering processes are combined into one by the crystallisation process, the unit often is compact (refer to Figure A).

Figure A: The four steps found in conventional treatment processes are combined into one by the crystallisation process

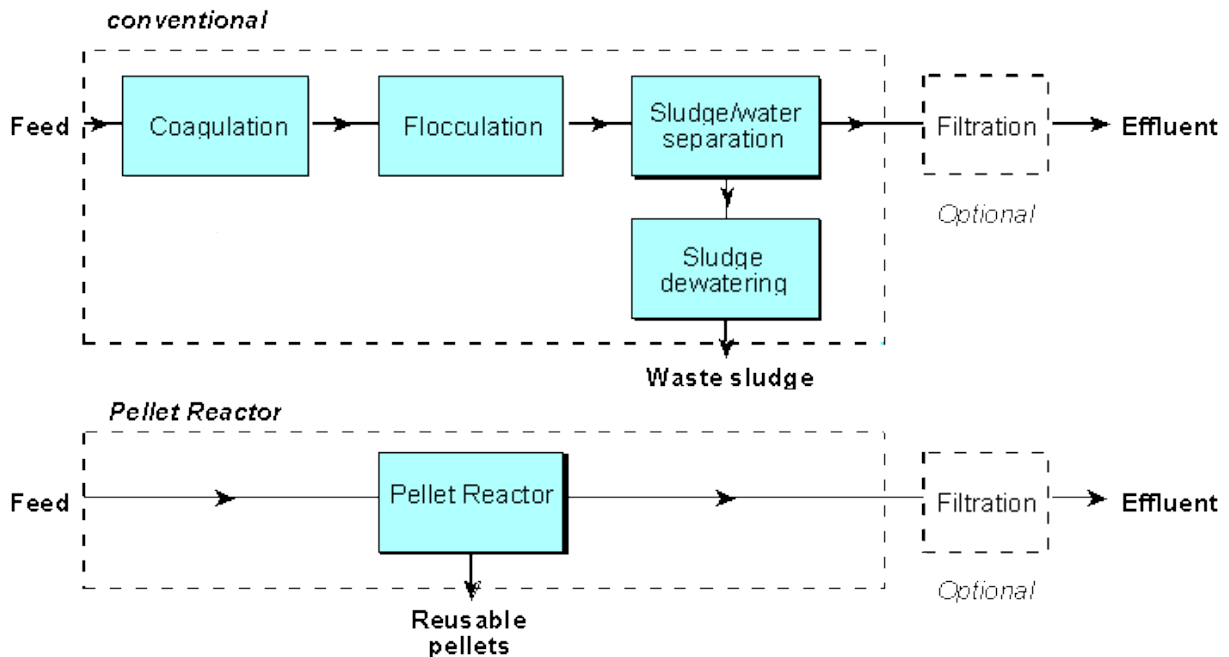

2.4 Selectivity

In general the crystallisation process enjoys a substantial higher selectivity than conventional precipitation. This is caused primarily by the selectivity related to the crystal structure and secondly by the fact that adsorption of impurities to the phosphate sludge flocs is minimal.

2.5 Process parameters

The efficiency of fluoride removal for the pellet reactor depends upon the following three process parameters

- reagent overdose and pH
- supersaturation
- hydraulic reactor load

Reagent overdose and pH

The pellet reactor effluent contains dissolved phosphate and suspended micro-crystals from nucleation. Nucleation is effectively minimised by the particular construction of the crystallizer and the choice of the appropriate degree of supersaturation. The dissolved phosphate concentration is fixed by the solubility product, the ionic reagent concentration and the process pH. This means, that the desired phosphate effluent concentration can be obtained by selection of the pH and reagent dosage. In practice at the optimal process pH, an overdose of 0.5-5 mol/m³ is applied

Supersaturation

At a given pH and overdose, the degree of supersaturation depends only upon the phosphate concentration of the wastewater. The phosphate concentration at the bottom of the reactor has to be maintained below a critical value in order to prevent primary nucleation. Moreover, the mechanical strength of the crystals decreases with increasing supersaturation. In practice, it has been observed that negligible nucleation occurs at a phosphate concentration of 25-125 mg/l P. This concentration is obtained in the pellet reactor by the correct selection of the circulation ratio, irrespective of the phosphate concentration in the wastewater.

Hydraulic reactor load

The hydraulic reactor load is the supernatant liquid velocity in the pellet reactor. This hydraulic load has to be selected in such a way that the pellet bed is fluidized. An increase in hydraulic load will result in an increase in secondary nucleation. In practice, good results are obtained for phosphate crystallisation with a hydraulic load of 40-75 m/h.

3 EXAMPLES OF APPLICATIONS

3.1 Phosphate recovery food industry

In the food industry waste waters with a high organic load are released. The waste water of a potato processing plant of AVEBE is treated in an anaerobic biological reactor because of the low sludge production, the low energy consumption and the biogas production. The effluent is polished in an aerobic biological treatment plant. Cost effective phosphate removal by struvite crystallization in the Crystalactor® was tested on semi-technical scale. $MgCl_2$ and $NaOH$ solutions were dosed into a part of the effluent of the anaerobic stage and in a fast reaction strong NH_4MgPO_4 crystals were formed. No filter is required because of the high crystallization efficiency and the fact that rest phosphate uptake takes place in the aerobic stage.



Phosphate recovery AVEBE

A flow of maximum $150\text{ m}^3/\text{h}$ with 120 ppm $PO_4\text{-P}$ was successfully treated in a Crystalactor® with a reactor diameter of 1.8 m).

The effluent contains about 10 ppm $PO_4\text{-P}$ and the pH is 8-8.5. The NH_4MgPO_4 pellets are reusable as "slow release fertilizers". The advantages of the Crystalactor® for AVEBE were:

- complete elimination of the existing struvite scaling problems downstreams of the anaerobic reactor;
- compact plant which is easy to insert between the anaerobic and the aerobic stage;
- compact reusable pellets were produced in stead of voluminous sludge;
- very competitive investment and operational cost.

3.2 Phosphate recovery municipal wastewater treatment plants

In 1988 the first full-scale application has been realised at the municipal wastewater treatment plant of Westerbork, The Netherlands.



Phosphate removal plant Westerbork

The plant operates successfully and removes phosphate below 1 mg/l P from the effluent of the biological section. No sludge is produced and the pellets are re-used by the phosphate processing industry. Since phosphate-free detergents are used in Dutch households, the phosphate concentration in raw municipal wastewater has decreased importantly. Direct phosphate removal from the effluent by the Crystalactor® is not economical anymore and the plant was closed.



Phosphate recovery at Geestmerambacht

For these lower inlet concentrations a combination of biological phosphate removal and the Crystalactor® as is applied at the municipal wastewater treatment plants of Geestmerambacht (230.000 p.e.) and Heemstede (35.000 p.e.) is more attractive. The process set-up is as follows: - a part of the return sludge is pumped to an anaerobic tank where acetic acid is dosed (other lower fatty acids are also possible);

- phosphate is released by the sludge in this anaerobic tank;
- the sludge is separated from the supernatant by a gravity-thickener in Geestmerambacht and a decanter in Heemstede;
- the thickened sludge is returned to the aeration tank where it takes up phosphate again;
- the phosphate is recovered from the supernatant by $\text{Ca}_3(\text{PO}_4)_2$ crystallization in the Crystalactor®; since the Crystalactor® is located in a side stream no filter step is required;
- the effluent of the Crystalactor® is returned to the aeration tank.

4 OTHER APPLICATIONS

The pellet reactor crystallisation technology is not only applied for phosphate recovery, but also for water softening, fluoride removal and heavy metal recovery. In principle all crystalline salts can potentially be removed from wastewater. As shown in table C, there is an extensive experience in removing most heavy metals and major anions, and the number of applications continues to grow. Metals are generally removed as hydroxide, carbonate or sulphide compounds.

Table C: Periodical system showing pellet reactor experience

1																	2
H																	He
3	4											5	6	7	8	9	10
Li	Be											B	CO ₃	NH ₄	O	F	Ne
11	12											13	14	15	16	17	18
Na	Mg											Al	Si	PO ₄	SO ₄	Cl	Ar
19	20	21	22	23	24	25	26	27	28	29	30	31	32	33	34	35	36
K	Ca	Sc	Ti	V	Cr	Mn	Fe	Co	Ni	Cu	Zn	Ga	Ge	As	Se	Br	Kr
37	38	39	40	41	42	43	44	45	46	47	48	49	50	51	52	53	54
Rb	Sr	Y	Zr	Nb	Mo	Tc	Ru	Rh	Pd	Ag	Cd	In	Sn	Sb	Te	I	Xe
55	56	57/71	72	73	74	75	76	77	78	79	80	81	82	83	84	85	86
Cs	Ba	La-Lu	Hf	Ta	W	Re	Os	Ir	Pt	Au	Hg	Tl	Pb	Bi	Po	At	Rn
87	88	89/103	104	105	106	107	108	109									
Fr	Ra	Ac-Lr	Rf-Ku	Ha-Ns	Unh	Uns	Uno	Une									

In some cases it has proved to be attractive to form metal phosphates. Anions are usually removed as calcium salts. Occasionally it is more desirable to form complex salts. For example, phosphate can be removed as NH_4MgPO_4 while simultaneously reducing the wastewater nitrogen content. The following picture shows some samples of produced pellets.





*Pellet reactors for softening of drinking water, Municipal Drinking Water Company of Amsterdam, The Netherlands
Capacity: 8,500 m³/h*



Pellet reactor for nickel and aluminium recovery, Shell Chimie, Berre, France

5 ENVIRONMENTAL SOUND OPERATION

Municipal wastewater treatment plants and commercial industries need cost-effective, compact and reliable technology to reduce waste emissions. Moreover, this technology has to provide a sustainable solution to the problem of avoiding secondary emissions. Secondary emissions such as waste sludges represent a growing environmental liability for those producing them. More important, they will increasingly be subject to ever-rising charges levied by the authorities, and ultimately their disposal will be prohibited altogether.

Consequently, industry has embarked on a new strategy to tackle environmental load problems. Alongside waste recovery - often referred to as reuse or recycling - waste prevention is now a key feature.

The Crystalactor® offers a sustainable solution to above mentioned problems and combines an environmental sound production or wastewater treatment with attractive economics.

"PHOSNIX" P-RECOVERY PROCESS

1. General Description

"PHOSNIX" is a trade name of a process to recover phosphate from waste water stream

as granules of Magnesium Ammonium Phosphate($MgNH_4PO_4 \cdot 6H_2O$, MAP or struvite) developed

by Unitika Ltd. Reaction of MAP formation is well known but separation of fine

crystals formed in the process is very difficult.

In the "PHOSNIX" process, fine crystals of MAP formed in a reaction vessel stick on

granules of MAP for easy separation.

2. Operation Experience

Waste Water Capacity	Operation started in	Type of Waste Water	Production of MAP
500 m ³ /day	1987	Night soil digestion	400 Kg/day
150 m ³ /day	1992	Sewage side stream	155 Kg/day
100 m ³ /day	1995	Industrial waste water	400 Kg/day
500 m ³ /day		Sewage side stream	400 Kg/day

Photographs below show the latest plant of "PHOSNIX" process and recovered MAP granules.



Latest "PHOSNIX" Plant built in 1998 for Sewage



Product used as Fertilizer

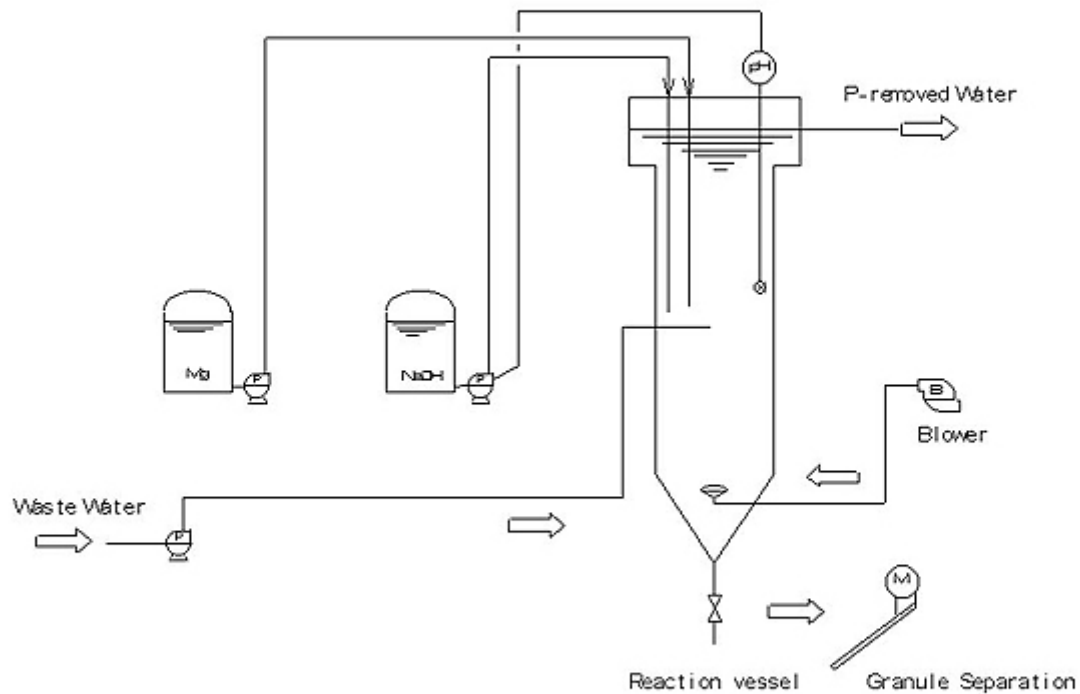

3. Process Description

Flow diagram of PHOSNIX" PROCESS is shown above.

Waste water containing phosphate is fed into the center of a reaction vessel where Magnesium ion and pH control agent are dosed and then fine MAP crystals are formed immediately. In the bottom part of the reaction vessel, MAP granules fluidized by air are retained and fine MAP crystals stick on the surface of the granules growing their size. Grown up MAP granules are discharged periodically from bottom of the reaction vessel.

4. Plant Description

A "PHOSNIX" plant is composed of the following equipment.

(1) Reaction Vessel one set

- (2) Chemical Supply Tanks two sets
- (3) Granule Separation Device one set
- (4) Waste Water Feed Pump two sets(one for stand-by)
- (5) Chemical Dosing pumps three sets(one for stand by)
- (6) Blower for Granule Fluidizing one set
- (7) pH Indicator/Controller one set
- (8) Control Panel one set
- (9) Magnesium Dosage Control Instrument Option
- (10) Product Packaging Device Option

Unitika supplies "PHOSNIX" plant for 100 m³ to 500 m³/day of waste water and 100 Kg to 500 Kg /day of MAP production.

5. Product Description

Product from "PHOSNIX" process, MAP, is an excellent fertilizer and currently is sold to fertilizer manufacturers at about 200 US\$ per ton in Japan.

The table below shows contents of the product.

	P	Mg	N	SS	TOC	COD
Actual	13.3%	11.5%	5.3%	0.3%	0.08%	0.3%
Theoretical	12.6%	9.9%	5.7%	-	-	-

Only trace of heavy metals is existed in the product and it is quite applicable for agricultural applications.

6. For more Information please contact the following address.

Unitika Ltd. Engineering Division

1-4-3 Kyutaromachi, Chuo-ku, Osaka, Japan

Phone 81-6-281-5314

Fax 81-6-281-5313

Mr.Christpher Thornton September 29, 1998

Research and communications coordinator for CEEP

Dear Mr. Thornton,

I am sending you a catalogue for "Phosnix" P-recovery process by E-mail above.

If you have any questions on the content, please contact me on Fax.

Sincerely yours

Hideo Katsuura

Unitika Ltd. Engineering Division

Phosphorus availability in the 21st century Management of a non- renewable resource

The article originally appeared in the Journal:
Phosphorus & Potassium, Issue No: 217
(September-October, 1998)

Reproduced with the permission of British Sulphur Publishing

High-grade phosphate ores, particularly those containing few contaminants, are being progressively depleted and production costs are increasing. Ingrid Steen, Group Agronomist, Kemira Agro, in Copenhagen, Denmark, examines the outlook for global phosphate rock supply and management of this non-renewable resource.

Today, the annual global production of phosphate is around some 40 million tonnes of P_2O_5 , derived from roughly 140 million tons of rock concentrate. Overall, mineral fertilisers account for approximately 80% of phosphates used worldwide with the balance divided between detergents (12%), animal feeds (5%) and speciality applications (3%), for example, food grade, metal treatment etc.

Considering the dominant role of fertilisers in global phosphate consumption, it is evident that the development of future world phosphate production will be driven by the development of agriculture, which in turn is driven by global population growth and its food requirement. It, therefore, follows that agriculture's share in the use of phosphate will increase in the future.

Estimates of world phosphate reserves and availability of exploitable deposits vary greatly and assessments of how long it will take until these reserves are exhausted also vary considerably. Furthermore, it is commonly recognised that the high quality reserves are being depleted expeditiously and that the prevailing management of phosphate, a finite non-renewable source, is not fully in accord with the principles of sustainability.

Phosphate rock and its characteristics

Phosphorus is the eleventh most abundant element in the lithosphere. Owing to its relative reactivity, it generally is associated with calcium (Ca), sodium (Na), fluorine (F), chloride (Cl), metals such as iron (Fe), aluminium (Al), magnesium (Mg), heavy metals, for example cadmium (Cd), radionuclides like uranium (U) etc. In reality more or less all the elements that can be found in the periodic table are represented in phosphate rock.

There are two main types of phosphate rock deposits, igneous and sedimentary, which have widely differing

mineralogical, textural and chemical characteristics.

The most prevalent phosphate minerals in these rocks are species of apatite, i.e. calcium phosphate with quartz, calcite, dolomite, clay and iron oxide as gangue components. Igneous rock is often associated with carbonatites and/or alkalic intrusions and is generally low in grade i.e. low concentration of phosphate. The abundance ratio of igneous versus sedimentary rock is 13 to 87. Some 80% of the world phosphate production is derived from sedimentary phosphate deposits.

More than 75% of the globally commercially exploited phosphate rock is surface mined, which can take many forms from manual methods to the employment of highly mechanised technologies, with the remainder recovered by underground mining.

Phosphate content in currently mined rocks can range from over 40% to below 5%. The mined rock is further processed to remove the bulk of the contained impurities and thus upgrade the rock. Consequently, the rock concentrate contains an increased apatite content of an improved quality. The beneficiation process usually allows a concentration of around 1.5x but higher ratios up to 9x are possible with some rocks. After beneficiation, phosphate rock (concentrate) generally ranges from 26% to about 34% P_2O_5 and up to as much as 42%

Phosphate rock can be beneficiated by many methods, and usually a combination of methods is used. In general, with the lower concentration of phosphate and lower quality deposit, the more waste is generated. Furthermore, more energy and chemicals are required per tonne of useful phosphate produced. Consequently, the cost for recovery and beneficiation of phosphate rock increases significantly in relation to lower grade and lower quality deposit. An analysis of production costs must thus be an integral part in the assessment of the lifetime of phosphate deposits and the likely cost of fertilisers in the future.

Most phosphate rock is further processed, but very small volumes are applied directly to acidic soils as fertiliser.

Global reserves

Phosphate rock deposits are found throughout the world and there are different definitions of the availability of these deposits. Reserves could broadly be defined as deposits that can be extracted profitably under current economics, infrastructure and technical conditions. Resources are defined as reserves (potential reserves) plus all other mineral deposits (geological resources) that may eventually become available. The potential reserves could probably be mined if the necessary investments were to be made, while the geological resources are identified as *in situ* resources.

Many reserve/resource estimates are subjective as they depend on standards and criteria assumed by the data provider in determining the circumstances that might render a deposit economically useful. Hence, it is to be noted that discrepancies exist. For example, the United States Geological Survey (USGS) has defined reserves as those exploitable at a cost below \$35/tonne and the reserve base as deposits that can be processed at a cost below \$100/tonne.

Over 30 countries are currently producing phosphate rock for use in domestic markets and/or international trade. The world's top 12 producing countries account for nearly 95% of the world's total phosphate production. The three major producing countries, i.e. the USA, China and Morocco, currently produce approximately two thirds of global phosphate production.

Of these three major producers, Moroccan reserves account for around 50% of the world total. Morocco is also in the most advantageous situation as its potential reserves and geological *in situ* resources have been estimated to be approximately 60% of total world resources. The USA and China have between them around 20% of global resources. These figures may be an underestimate as they are based on calculations of economic production for the foreseeable future.

Current world phosphate rock production capacity is estimated at around 165-195 million t/a, or approximately 50+ million t/a P_2O_5 .

The amount of phosphate rock reserves and resources in individual countries are rather uncertain as this type of data is often privileged information and documentation concerning many deposits is simply not available. Furthermore, there is generally a lack of information concerning the extent of exploration and criteria used to determine the economics of production or the potential for economic development. Thus, *table 1* is based on a collection of data from different sources that are not always comparable, and most of the data is more than ten years old. To demonstrate the discrepancies in estimates of phosphate reserves, there are differences between sources as much as 100% so a substantial range is evident.

	% of total (1996): Production	Reserves	Potential Reserves	Geological Resources
United States	34	4-10	7-13	
China	16	2-25	2-10	
Morocco	16	46-53	63	
Russia	6	3	7-10	
South Africa	2	9-22	3-22	
Tunisia	5	1	1	
Jordan	4	2-3	1-3	
Iraq	–	1	3	
Brazil	3	1-3	1-2	
Peru	–	1	–	
All other countries	14			
Total P_2O_5 (million tonnes)	38	3,600-8,000	11,000-22,000	30,000

Source: United States Geological Survey, International Fertilizer Industry Association and British Sulphur

Quality depletion and cost implications

There is a limit to the phosphate rock reserves that can profitably be recovered at current market prices. High-grade ores with high P_2O_5 concentration and ores of good quality i.e. containing few contaminants, are being progressively depleted. Consequently, production costs will increase.

It has been widely suggested for many years that, in general, there has been a continuous decrease in world phosphate rock quality as reserves of high-quality rock are being depleted. It might be more appropriate to say that high-grade concentrates from some sources are becoming depleted, principally Florida, and, in general, the quality of phosphate rock that is utilised on a worldwide basis is decreasing. High-grade phosphate rock is available from many sources, such as Togo, Senegal and Morocco. However, premium rocks from these sources are not available at costs comparable to those 20 or 30 years ago.

Higher P_2O_5 content equates to lower impurity content, higher yields per tonne of material shipped, handled and processed, increased reaction efficiencies, fewer processing problems and less waste. An industry assessment suggests that the phosphate content of pre-beneficiated ore is already decreasing by around 1% per decade.

In the context of declining quality, the levels of certain impurities may pose problems in the processing or in

application. The content of heavy metal contaminants are generally higher in sedimentary than igneous rocks. To date, levels have not proved a problem except when producing higher purity phosphoric acid grades. However, certain European countries have applied strict limits to cadmium levels in fertilisers in order to avoid contamination of farmland and crops and cadmium removal could involve further processing costs adding 2-10% to phosphate fertiliser prices.

Radionuclides do not interfere with any employed processing technologies. However, they must be considered in the production of high-grade phosphoric acid and because of potential health hazards, not least in connection to stockpiling or depositing phosphogypsum at landfills from processing certain rocks. Phosphogypsum from Florida rock is subject to specific management restrictions by law. It is likely that in the future further environmental pressure will influence mining, processing and waste management at the processing plants and definitely also increase the cost of phosphate production.

Production costs and phosphate availability

A number of analyses on production costs for different producing mines and potential mines and deposits have been made. The most significant factors altering the cost situation for recovery and processing of phosphate rock and thus the profitability would be; accessibility of the ore, degree of beneficiation required, capital investment, operating costs and, availability and cost of other resources.

Some calculations – shown in *figure 1* – are important for the estimates of the amount of commercially exploitable phosphate deposits. There, calculations were made in 1985; nevertheless, the analysis is still relevant.

Fig. 1: Phosphate rock production costs

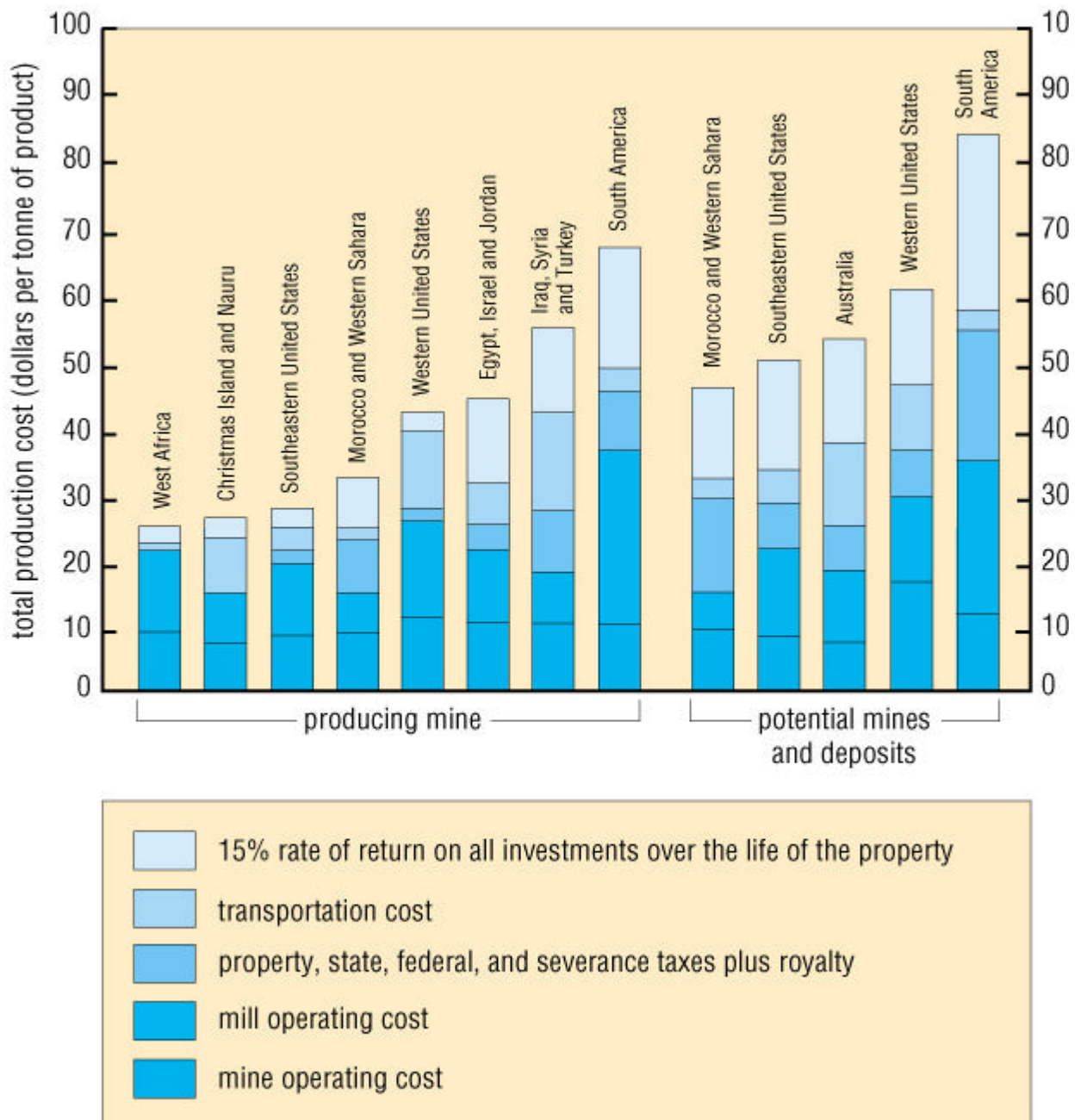

Source: Fantel et al.

To illustrate the complexity of these assessments, USGS data is used where reserves are defined as those commercially exploitable at a cost of less than \$35/tonne. Supposing a cost of around \$60/tonne, this would more than double the available commercial phosphate deposits in the USA. It is reasonable to assume a similar situation in other phosphate producing countries, using USGS assumptions. Consequently, with an eventual increase in price for phosphate, a reclassification of some resources to reserves would be the outcome.

Population trends and food requirement

The increase in life expectancy, reduced child mortality and improved farming methods, which have led to increased food production, have resulted in a rapid and exponential world population growth over the last 150 years, from 1 billion to an anticipated 6 billion in 1999.

World population is currently growing by approximately 1.5% per year, 80 -85 million per year, or 250,000 people every day. This trend will not continue indefinitely. The latest UN World Population Projections to 2150 suggest that a slowing down of population growth may be already occurring with a median projection of 9.4 billion by 2050 (see *figure 2*). The population growth is expected to be concentrated in the developing regions of the world, mainly Africa and Asia, while in the developed countries growth will be very slow.

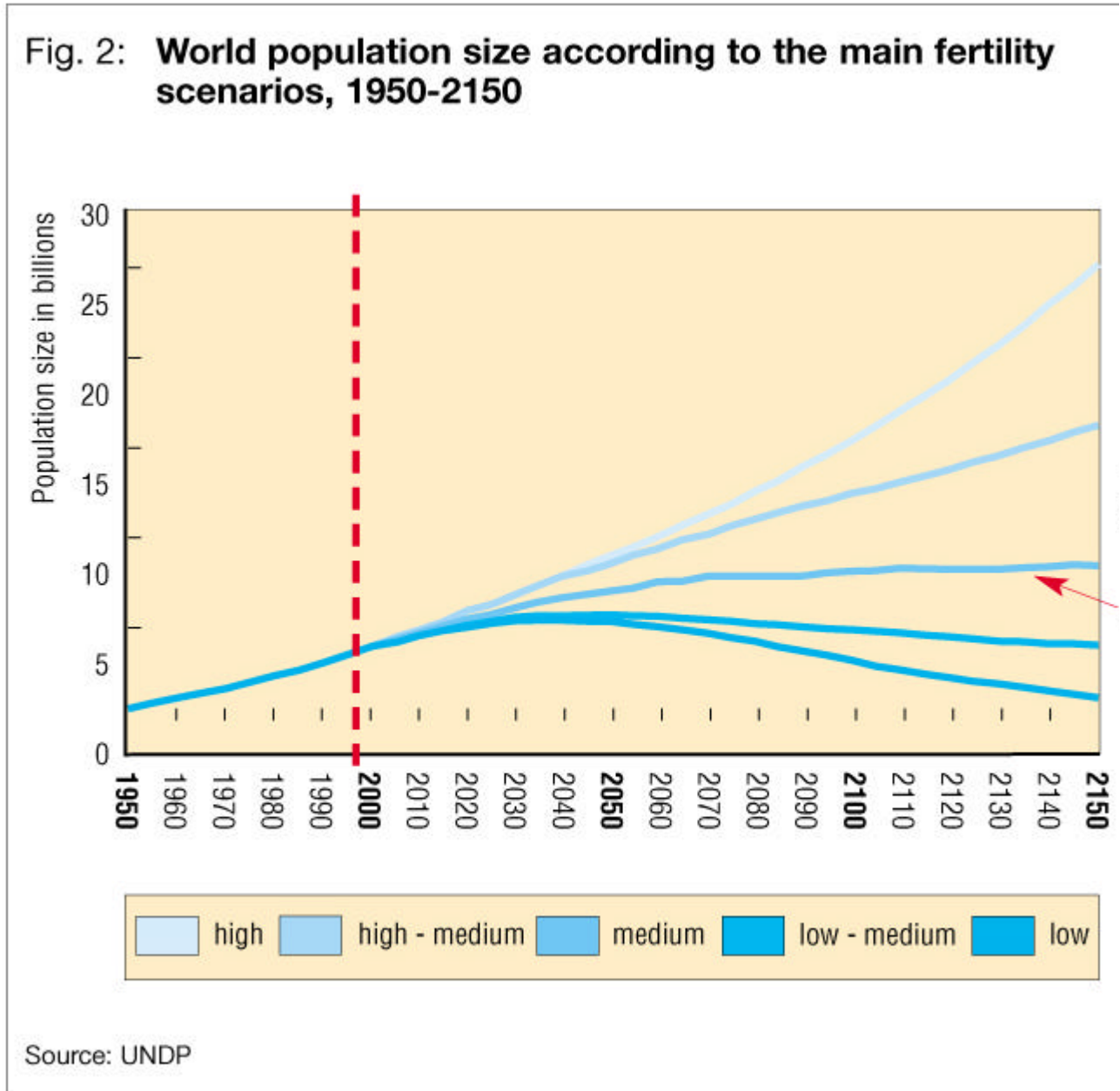

The expanding population will take pleasure from increasing incomes and more people will profit from economic growth and further improvements in their standard of living. A 50% population increase over the next 50 years would point towards an increase in global food needs by at least a proportionate figure, assuming a roughly constant per capita cereal consumption.

However, the combined effects of rising population and wealth will inevitably increase the demand for higher dietary standards and higher-grade foodstuffs. Consequently, the portion of meat and possibly also of dairy products in the diet will increase. But, even if a higher dietary standard could be afforded it is not likely that

there will be a total change to Western-like diets because many communities are likely to retain their traditional cooking to a great extent. Thus it is difficult to assess the time scale and magnitude of this development and consequently the impact on phosphate consumption.

Meat production is inefficient at both energy and nutrient conversion; the cereals to meat conversion ratio in intensive animal husbandry is 3:1 for poultry, 4.5:1 for pork and 6:1 for red meat. This implies that increasing the meat consumption, increases the need for cereals and hence, agricultural phosphate use by a factor related to these ratios. Nevertheless, increased animal production should focus the need for more efficient recycling of the nutrients, especially phosphate in the animal excreta.

Despite all the efforts to feed the world population, approximately 800 million people are still undernourished. On a worldwide basis the dietary energy supply (DES) has grown to an average of 2,720 kcal per person per day, according to data from 1992. This represents an 11% increase over 20 years, despite growth in the world population of almost 40% over the same period. This can be compared with a minimum sustenance level estimated to be not less than 1,700 kcal DES. Furthermore, when current food and population trends are extrapolated, it seems likely that at least 5% of the population in these countries will still be undernourished by 2050.

As demand for food increases, this may result in bringing into agricultural use more land, but certainly will bring a requirement for increased yields, thus increasing fertiliser demand. Hence, agricultural phosphate use may increase faster than world population.

Agricultural demands

Phosphorus is an essential nutrient for all life forms and is a key element in many physiological and biochemical processes. It was the first element to be recognised as an essential nutrient for plants and its functions cannot be performed by any other nutrient.

In the natural environment, phosphorus is supplied through the weathering and dissolution of rocks and minerals with very low solubility. Therefore, phosphorus is usually the critical limiting element for animal and plant production and throughout the history of natural and agricultural production, phosphate has been largely in short supply.

The importance of recycling organic manures to maintain crop production has been recognised by farmers for thousands of years. However, the nutrient recycling loop is broken as increases in production and exports of agricultural produce require external nutrient input to improve and maintain soil fertility.

External phosphate inputs have become available on a large scale with the mining of phosphate deposits and increased availability of phosphate fertilisers. The success of this development is evident in all developed countries, where serious plant and animal health problems due to phosphate deficiency have been eliminated.

On a global basis, there is a positive balance in phosphate trade. However, phosphate remains in short supply in many countries of the world owing to economic and political constraints.

For more than a century, when modern fertiliser practices have been introduced they have been instrumental in increasing the quantity and quality of agricultural output. The use of mineral fertilisers has made it possible to provide enough food to feed the world's growing population. Mineral fertiliser use is thus a key aspect of economic development and human health.

The world needs food, fibres and raw material produced by agriculture in an ever-increasing amount. This will have to be achieved with little prospect of further increases in the total agricultural area. The required increase in crop production will have to be derived from both yield increases and more intensive cropping on land currently under cultivation.

Cereals, rice, wheat, maize etc are the main source of nourishment for the world's population. Cereal

production has kept slightly ahead of population. Over the last 25 years the global cereal production has increased by some 65%. The rise in cereal production has been achieved by better yields rather than by the cultivation of new land.

Much of the growth in global cereal production occurred in developing countries. These countries increased their production of cereals by more than 85% between 1970 and 1995 but from a very low base. Taking the population growth into account during this period, the per capita cereal production in developing countries has gone up by 15% to about 260 kilograms per person each year. In the industrial countries the comparable figures are 10% and approximately 600-650 kilograms. However, over the last few years there has been a slowdown in the growth of global per capita cereal production.

Based on current information, around 50% of the nutrients, including phosphate, used in agriculture, are used in cereal production (see *table 2*). Using this assessment, knowing global cereal yields, the global grain to phosphate (P_2O_5) ratio would be 130:1. Crop phosphate content of P_2O_5 varies from 0.5-2% of dry matter and cereals contain 0.75-1%. This also corresponds to the grain to phosphate ratio of 130:1 indicated above.

Table 2: Estimated world fertiliser usage by crop grouping	
	Percentage of world usage
Wheat	20
Corn	14
Rice	13
Barley	4
All other cereals	4
Oilseeds	12
Roots and tubers ¹	6
Fruits and vegetables	5
Sugar	4
Fibres	4
Other crops ²	3
Pasture/hay ³	11
Total	100
¹ Primary potatoes	
² Includes cocoa, coffee, tea, tobacco and pulses	
³ Includes grassland, fodder, silage, etc	
Source: IFA	

Annual global cereal production is around 2,000 million tonnes currently. It is produced on half the arable land area, i.e. some 700 million hectares. The average cereal yield is around 2.8 tonnes per hectare; 3.0 in developed countries and 2.6 in developing countries. The annual yield increases over the past few decades have averaged 2-2.5% but have declined recently to around 1.5%. If the growth rate returns to some 2.5% or becomes even higher with the introduction of new varieties and the cereal to phosphate ratio remains at 130:1, increasing crop yields levels will clearly require more nutrients. It can be assumed that there will be a similar development for other crops.

Phosphate efficiency is relatively low in any agricultural system. During the first year after application, only

some 15-25% of the phosphate is generally taken up by crops as most of it is fixed in the soil and thus is not available to crops for a long period. Much of the residue remains in the soil to increase phosphate reserves but only a small proportion of each residual increment is available to following crops.

In many Western countries the soil fertility has been improved over the years by repeated application of phosphate fertilisers, increasing soil phosphorus levels, so that it is now possible to harvest some of the phosphate that has been accumulated in the soils. In these areas, depending on climate and soil conditions such as soil structure, soil type, pH, other soil constituents, etc., an appropriate policy for fertiliser application which enables crop yields to be sustained, might be to only replace the phosphate taken off in the harvested crop and thus maintain or permit a slow decline of the present soil phosphate status. In developing countries, on the other hand there is a need to develop soil fertility and phosphate levels are often the limiting factor for crop yields.

Phosphate use in agriculture

World fertiliser consumption has increased tenfold since 1930 and almost sixfold from approximately 5 million tonnes of phosphates in 1950 to 30 million tonnes in 1995. This gives an average annual growth rate of some 4% (see *figure 3*). However, the global fertiliser consumption growth rate has levelled out, the peak year being 1988 with a total consumption of 37.7 million tonnes P_2O_5 .

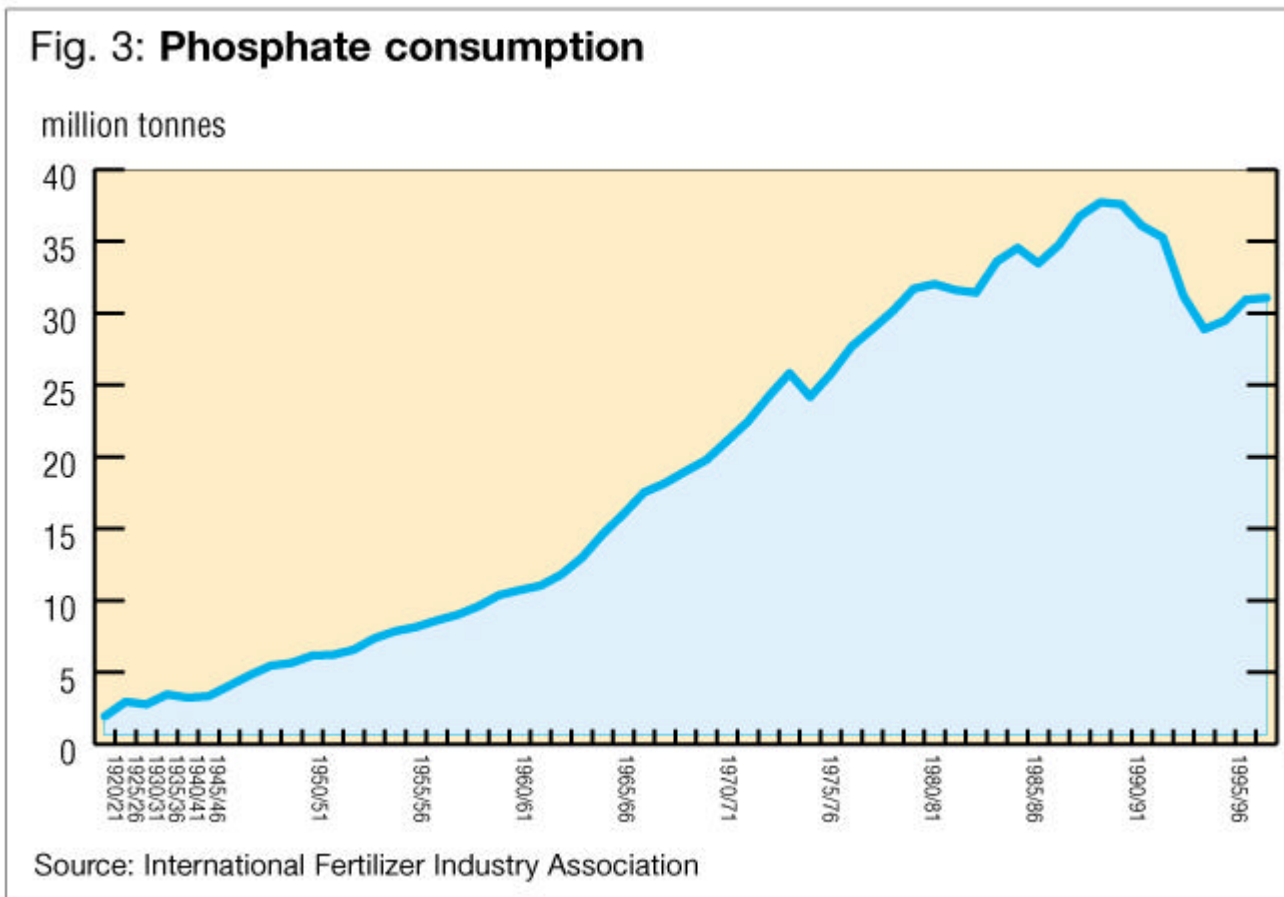

There is a clear contrast between phosphate consumption development in developed and developing countries. Over the last 25 years, farmers in developing countries have increased their overall fertiliser use more than five times and the phosphate use has increased sixfold to the present level of 18 million tonnes. In developed countries phosphate fertiliser use is now what it was 30 years ago. During the 1980s, the P_2O_5 consumption was levelling at around 22-23 million tonnes and has since declined by almost 50% to the current level of some 12 million t/a P_2O_5 (see *table 3*).

Table 3: Phosphate use in different parts of the world in 1995

	% of total	Million tonnes	Kg/ha of arable land ¹	Range of application rates to cereals kg/ha	Average kg/cap
Global	100	31	23 (0-250)	0-100	4
West Europe	12	3.5	25 (10-165)	10-40	9
CEE + FSU	7	2	7.5 (0-130)	0-60	4
USA	13	4	21.5 (5-120)	5-65	14
Developed countries	39	12	18	–	9
Developing countries	61	19	27	–	4

¹ Assumption: All phosphate fertilisers being used in arable land i.e. permanent crops, excluded

In some regions of Europe and locally in the USA and Central and Eastern Europe, there is an oversupply of phosphate to agriculture due to the large combined input of phosphate in the form of fertilisers and organic manures derived from feed and feed supplements. In large parts of the developing countries, on the other hand, there is an insufficient supply of phosphate both in terms of total application and imbalance in the N to P to K ratio. If many of the areas being farmed today were to receive sufficient phosphate to prevent mining of soil reserves, this in itself would substantially increase world demand.

An assessment for West Europe shows that the amount of phosphate excreted by livestock in this region could be some 50% more than the amount currently applied as mineral phosphate fertiliser. However, all of it is and cannot be efficiently used as many animals are grazing in fields and not kept in stables. Thus, all the manure is not collectable for spreading. Nevertheless, a limited quantity – perhaps up to around 40% – of the phosphate contained in manure could be more effectively spread onto agricultural land. The amount of phosphate is equal to a maximum of 1.5 to 2 million tonnes P_2O_5 , which could replace an equivalent quantity of P_2O_5 as mineral fertiliser. In general, it is difficult to assess the amount of mineral fertiliser phosphate that could be replaced by a more efficient use of animal excreta since much data is not available. A rough world estimate would be that some 4-5 million tonnes of mineral fertiliser phosphate could be replaced by a more efficient use of manure, mainly in regions of Europe and the USA.

Phosphate consumption scenarios

The traditional approach to forecasting phosphate fertiliser demand has been to use a linear model. However, most forecasters often restrict their assumptions to the next five to ten years and this provides little help for calculating the approximate lifetime of phosphate reserves. The most conservative and simplistic approach for assessing the lifetime of phosphate reserves is to calculate how long the reserves will last based on present consumption. This provides a basis for simple comparisons but does not say very much about anticipations of future development. The reason for these approaches is the difficulty in predicting demand that depends largely on the development of market economy and political circumstances.

The current fertiliser industry forecast on the development of global phosphate consumption suggests an annual increase of approximately 3% until the first years of the next century. Some fertiliser manufacturers have extended their forecast into the early part of next century, 2010-2015, suggesting an increase in phosphate fertiliser consumption of 2.8% per year before it begins to level off.

The view that crop yields might increase by some 2-2.5% per year matches the long-term historical cereal yield trends. With this view, it is assumed that agricultural production will continue to keep pace with, or slightly exceed, the global population growth and hence the world per capita crop production would remain stable or slightly increase.

This would lead to a first estimate of a 2.5% annual growth in phosphate consumption over the long term. This would, in turn imply an additional consumption of 10 million tonnes of P_2O_5 between the years 2000 to 2010, an additional 13 million tonnes between 2011-2020, and close to 20+ million tonnes between 2021 -2030. In total, this would amount to an annual consumption of around 100 million tonnes of P_2O_5 in 2050. This is more than three times the current consumption in global agriculture and would equal an average supply of some 70 kg P_2O_5 per hectare, which certainly would be regarded as an oversupply of phosphate.

A workable assumption is that Western agriculture, i.e. in the developed world, would not need to supply more phosphate than that removed by the harvested crop. In approximately 50% of the remaining agriculture it would be feasible to improve the soil phosphate status, and in the other 50% slightly more than replacement would be a relevant policy. Furthermore, it could be assumed that the crop uptake efficiency of phosphate fertilisers could improve in the future due to improved farming technologies, nutrient management and plant breeding.

Using these assumptions, the phosphate fertiliser consumption in developed agriculture could stabilise at its present level of around 20-25 kg phosphates per hectare as an average with a possible slow increase starting some 20 years from now. Further, recycling of nutrients will improve in the developed world, somewhat reducing the need to add mineral phosphates. In those developing countries where it is necessary to improve soil fertility, it could be necessary to supply some 30-50% more phosphate than crop requirements for a period of perhaps 30-50 years. After this, it would be necessary to maintain the phosphate status of the soil as in countries where this is done currently. In other countries, where the soil phosphate status should be maintained, it may be necessary to add 10-30% more phosphate than is removed by the harvested crop. This scenario gives a second more realistic estimate for annual P_2O_5 consumption in 2050 of around 70 millions tonnes.

The development of world agricultural phosphate consumption until 2050, according to the above scenarios, is summarised in *figure 4*.

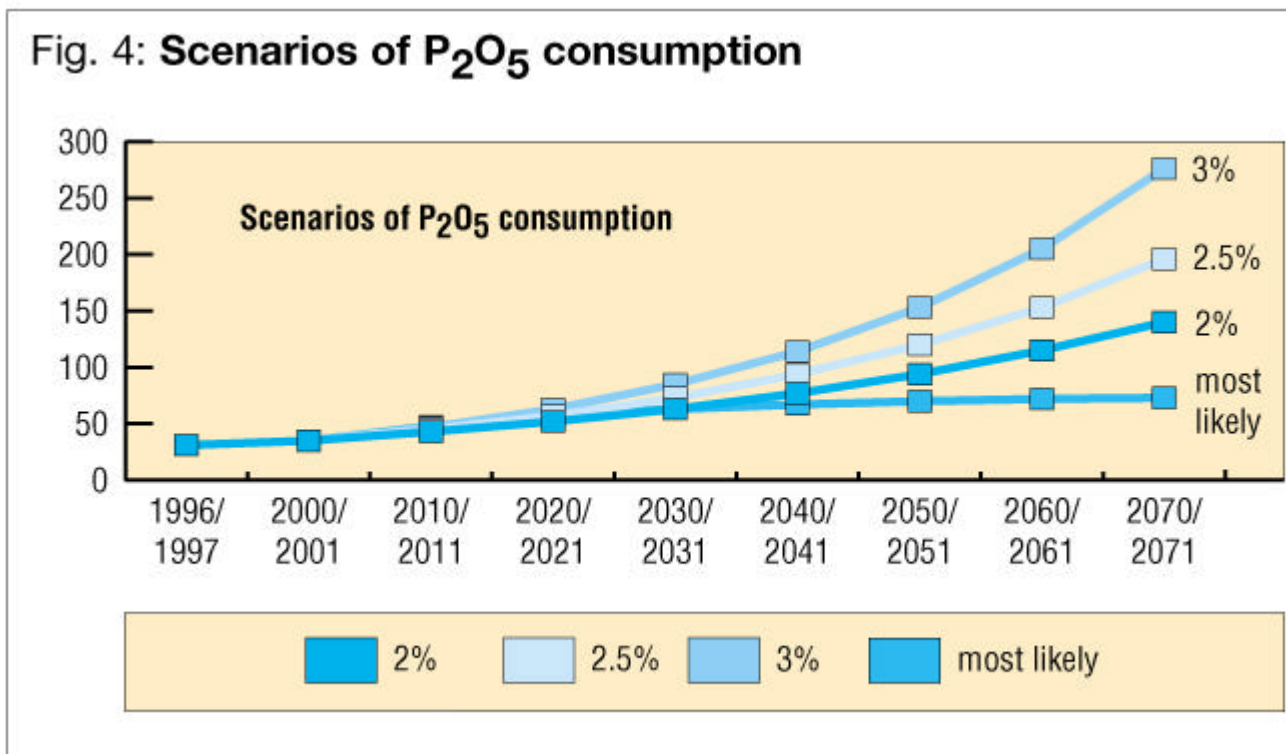

Lifetime of global reserves

By applying the phosphate consumption growth rates estimated in the *Phosphate use in agriculture* section, world fertiliser use would reach 60-70 million t/a of phosphates by 2050. It is concluded that global phosphate resources extend, for all intents and purposes, well into the future, but that depletion of current economically exploitable reserves can be estimated at somewhere from 60 to 130 years. In essence, using the median reserves estimates and under reasonable predictions, it appears that phosphate reserves would last for at least 100+ years (see *figure 5*).

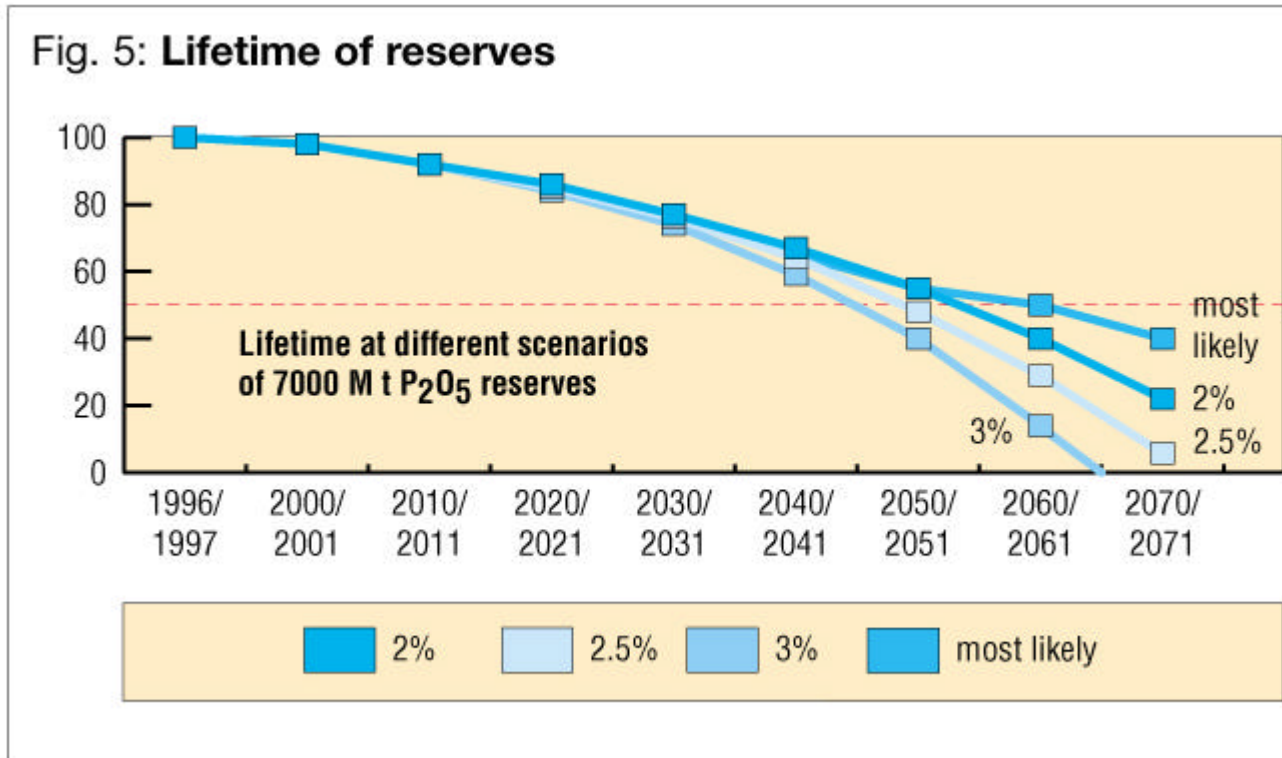

The data presented here, based on reasonable assumptions, suggests that within a time horizon of some 60-70 years about half the world's currently economic phosphate resources will have been used up. Furthermore, current global phosphate capacity will be utilised at its maximum production level in 10 years. This may lead to a progressive increase in prices, both as extraction costs rise, as countries holding deposits become conscious of their depletion and scarcity value, and maybe above all because of increases in processing costs. The phosphate content of pre-beneficiated ore will continue to drop, leading to proportionately increasing quantities of waste and costs for disposal. Also, the degree of impurities will progressively increase as the better quality reserves are used up and this will increase processing costs.

The information used in the article was gathered from a large number of sources of which the following are the most significant:

1 EFMA, 1997, *Fertiliser forecast* and other documents

1 FAOSTAT *database*, 1998, and other documents.

1 IFA, 1998, *Statistics*, and other documents.

1 IFDC, 1998, *Fertiliser Manual*.

1 United Nations, 1992, 1995, 1998, *World Population Projections*.

1 *Fertiliser Society Proceedings*, 1993-1997.

CAPTIONS

Surface mining of phosphate rock can take many forms from manual methods (left) to the employment of highly mechanised technologies (right).